

MOTION & CONTROL™

**NSK**

PRICE LIST | PREISLISTE  
TARIF | TARIFA DE PRECIOS  
LISTINO PREZZI | PRISLISTA



## Introduction

As one of the world's leading manufacturers of rolling bearings, linear technology components and steering systems, we can be found on almost every continent – with production facilities, sales offices and technology centres - because our customers appreciate short decision-making channels, prompt deliveries and local service. NSK went into business as the first Japanese manufacturer of rolling bearings back in 1916. Today around the world, some 28,500 employees work in close cooperation with our customers.

NSK Bearings are renowned for their quality. Our comprehensive range of 35,000 products means that we can offer our customers bearings for most applications at the highest quality.

For further information on our products and solutions visit our website [www.nskeurope.com](http://www.nskeurope.com).

### Notes

- Whilst all efforts have been made to ensure the accuracy of the information included in this Price List, the publishers cannot accept responsibility for the information contained within.
  - This price list is valid from 1st of July 2014 and replaces all previously published price lists.
  - All prices exclude VAT.
  - Where both NSK and RHP brands are shown for a similar part number, please refer to the appropriate catalogue for full specification details.
  - To ensure that our bearings remain in optimum condition during storage and distribution, some items are only available in minimum quantities e.g. small size ball bearings are supplied in factory-sealed packaging.
  - C3 clearance bearings are priced the same as bearings with CN clearance. Please contact your sales department for other clearances.
  - Please note that throughout the price list **M** indicates a brass cage. If a particular type of brass cage is required then please contact your local NSK sales office.
  - Our standard Terms and Conditions apply.
-

## Einführung



Certified Company

Als einer der weltweit führenden Hersteller von Wälzlagern, lineartechnischen Komponenten sowie Lenksystemen sind wir auf allen Kontinenten vertreten – mit Werken, Vertriebsniederlassungen und Technologiezentren. Denn unsere Kunden schätzen kurze Entscheidungswege, prompte Lieferungen und Service vor Ort. Bereits 1916 startete NSK seine Geschäfte als erster japanischer Hersteller von Wälzlagern. Heute arbeiten weltweit mehr als 28.500 Mitarbeiter sehr eng mit den Kunden zusammen.

NSK Wälzlager sind für ihre ausgezeichnete Qualität bekannt. Unsere Produktpalette umfasst mehr als 35.000 verschiedene Produkte. Das bedeutet, wir können unseren Kunden beste Qualität für die unterschiedlichsten Anwendungen anbieten.

Weitere Informationen über unsere Produkte und Lösungen finden Sie auf unserer Website [www.nskeurope.de](http://www.nskeurope.de).

### Anmerkungen

- Wir haben uns die größte Mühe gegeben, die Richtigkeit der in dieser Preisliste gemachten Angaben sicherzustellen. Der Herausgeber kann jedoch keine Haftung für unvollständige oder fehlerhafte Angaben übernehmen.
- Diese Preisliste ist ab dem 1. Juli 2014 gültig und ersetzt alle zuvor veröffentlichten Preislisten.
- Die genannten Preise verstehen sich exklusive MwSt.
- Wenn für ein Produkt sowohl NSK- und RHP-Bezeichnungen angegeben werden, entnehmen Sie die vollständigen Spezifikationen bitte aus den entsprechenden Katalogen.
- Um sicherstellen zu können, dass unsere Lager während der Lagerung in optimalem Zustand bleiben, sind manche Produkte nur in Mindestmengen erhältlich. Wir behalten uns deshalb vor, bestellte Mengen auf komplette Verpackungseinheiten zu erhöhen.
- Lager mit C3-Lagerluft werden wie Lager mit CN-Lagerluft berechnet. Preise für andere Lagerluftklassen können Sie bei unseren Verkaufsteams erfragen.
- Hinweis: Der Buchstabe **M** weist in der gesamten Liste auf einen Messingkäfig hin. Falls Sie einen bestimmten Messingkäfig-Typ benötigen, dann setzen Sie sich bitte mit Ihrer zuständigen NSK-Verkaufsabteilung in Verbindung.
- Es gelten unsere allgemeinen Verkaufs-, Liefer- und Zahlungsbedingungen.
- Der Mindestbestellwert beträgt 200€ um die hohen administrativen Kosten von Kleinaufträgen zumindest teilweise abdecken zu können.

## Introduction

Présents sur tous les continents grâce à notre réseau mondial d'usines, de filiales de distribution et de centres de recherche, nous sommes l'un des leaders mondiaux en roulements, composants linéaires et systèmes de direction. Nos circuits de décision raccourcis, la rapidité de nos livraisons et la proximité de notre service après-vente sont particulièrement plébiscités par nos clients.

NSK a démarré son activité en tant que premier constructeur japonais de roulements en 1916. Aujourd'hui, près de 28 500 employés travaillent en étroite collaboration avec nos clients, dans le monde entier.

Les roulements NSK sont reconnus pour leur qualité. Notre large gamme, composée de 35 000 produits, nous permet de proposer à nos clients des roulements de qualité, pour la plupart des applications.

Pour plus d'informations sur nos produits et solutions, n'hésitez pas à visiter notre site [www.nskeurope.fr](http://www.nskeurope.fr).

### Notes

- Le plus grand soin a été apporté à l'exactitude des informations contenues dans ce tarif, mais aucune responsabilité ne saurait être acceptée pour tout erreur ou omission.
  - Cette liste de prix est valable à compter du 15 juillet 2014 et remplace les listes de prix précédentes.
  - Tous les prix s'entendent unitaires, hors taxes.
  - Afin de préserver au maximum les roulements pendant les phases de transport et de stockage, certains produits ne sont disponibles qu'en quantité de conditionnement, par exemple : les roulements de petite taille sont fournis en emballage scellé à l'usine.
  - Les roulements avec jeu interne C3 sont au même prix que les roulements avec jeu interne CN. Veuillez contacter notre service commercial pour les prix des roulements avec une autre classe de jeu interne.
  - Veuillez noter que, dans toute la liste de prix, **M** indique une cage en laiton. Si vous désirez un type particulier de cage en laiton, veuillez contacter votre bureau de ventes NSK local.
  - Nos modalités de paiement standard s'appliquent.
-

## Introducción a la tarifa de precios

Como uno de los principales fabricantes de rodamientos, componentes de tecnología lineal y sistemas de dirección, estamos presentes en prácticamente todos los continentes - con plantas de producción, oficinas de ventas y centros tecnológicos - porque nuestros clientes valoran la proximidad para la toma de decisiones, las entregas rápidas y el servicio local. NSK como primer fabricante de rodamientos japonés, fue fundada en 1916, ahora aproximadamente 28.500 empleados trabajan en estrecha colaboración con nuestros clientes.

Los rodamientos NSK son reconocidos por su calidad y están considerados por nuestros clientes como los mejores rodamientos disponibles en el mercado. Nuestra extensa gama de rodamientos, con más de 35.000 referencias, permite cubrir la mayoría de las aplicaciones y con la mejor calidad.

Para más información sobre nuestros productos y servicios visite nuestra página web: [www.nskeurope.es](http://www.nskeurope.es).

### Notas

- Aunque hemos hecho todos los esfuerzos posibles para asegurar la exactitud de la información incluida en esta Tarifa de Precios, el editor no acepta ningún tipo de responsabilidad por la información contenida en ella.
  - Esta tarifa de precios es válida desde el 1 de Julio 2014 y reemplaza a todas las anteriormente publicadas.
  - IVA no incluido en los precios.
  - Para asegurar que nuestros rodamientos permanecen en condiciones óptimas durante el almacenamiento y distribución, algunos rodamientos están sólo disponibles en cantidades mínimas, p.ej., los rodamientos de bolas de pequeño diámetro, se suministran en paquetes cerrados desde fábrica.
  - Los rodamientos con juego radial C3 tienen el mismo precio que los rodamientos con juego radial CN. Rogamos contacte con nuestro departamento de ventas para otros juegos radiales.
  - El sufijo **M**, indica jaula de bronce. Si se requiere otro diseño de jaula de bronce por favor contacte con NSK.
  - Son aplicables a esta Tarifa de Precios nuestras Condiciones Generales de Venta que las encontrará en nuestra página web [www.nskeurope.com](http://www.nskeurope.com).
-

## Introduzione

Leader mondiale nella produzione e nello sviluppo tecnologico di cuscinetti volventi, prodotti lineari ed automotive e di sistemi sterzanti, NSK è un'organizzazione presente in ogni continente – con stabilimenti di produzione, uffici vendite e centri tecnici pronti a soddisfare le esigenze dei clienti attraverso canali di comunicazione diretti, servizi in loco e consegne rapide.

NSK è stato il primo produttore giapponese di cuscinetti volventi. L'attività di produzione è iniziata nel 1916. Oggi NSK può contare su uno staff di oltre 28.500 dipendenti in 29 Paesi di tutto il mondo, che operano in stretta collaborazione con i propri clienti.

I cuscinetti NSK sono rinomati per la loro qualità. Il range è composto da più di 35.000 prodotti. Ciò significa essere in grado di offrire ai clienti NSK le soluzioni più adatte alle proprie esigenze garantendo gli standard di qualità più elevati.

Per ulteriori informazioni sui nostri prodotti e sulle nostre soluzioni visitate il sito [www.nskeurope.it](http://www.nskeurope.it).

### Note

- Sebbene sia stata posta la massima attenzione per garantire l'accuratezza dei dati contenuti nel presente Listino Prezzi, gli editori declinano qualunque responsabilità relativa alle informazioni in esso contenute.
  - Il presente Listino Prezzi è valido a partire dal 1 Luglio 2014 e sostituisce tutti i listini prezzi precedentemente pubblicati.
  - Tutti i prezzi riportati sono da intendersi IVA esclusa.
  - Quando sono disponibili cuscinetti con marchio sia NSK che RHP, consultare il relativo catalogo per le specifiche tecniche.
  - Per preservare le condizioni ottimali dei nostri cuscinetti durante la movimentazione e lo stoccaggio, alcuni prodotti sono disponibili solo in quantità minime, ad esempio i cuscinetti a sfere di piccole dimensioni sono forniti in confezioni sigillate in fabbrica.
  - Il prezzo dei cuscinetti con gioco C3 è uguale a quello dei cuscinetti con gioco CN. Per altri giochi si prega di contattare il nostro Ufficio Commerciale.
  - La lettera **M** nel presente Listino Prezzi indica una gabbia in ottone. Per gabbie in ottone di tipo particolare si prega di contattare l'ufficio commerciale NSK di zona.
  - La presente documentazione è soggetta alle nostre Condizioni Generali di Vendita standard.
-

## Introduktion

Som en av världens ledande tillverkare av rullningslager, linjära komponenter samt teknik och styrinrättningar kan vi hittas på nästan alla kontinenter - med produktionsanläggningar, försäljningskontor och teknikcenter - eftersom våra kunder uppskattar korta beslutsvägar, snabba leveranser och lokal service. NSK startades som första japanska tillverkare av rullningslager redan 1916. Idag arbetar cirka 28.500 anställda i nära samarbete med våra kunder runt hela världen.

NSK Lager är kända för sin kvalitet. Vårt omfattande sortiment av 35.000 produkter gör att vi kan erbjuda våra kunder lager för de flesta applikationer av högsta kvalitet.

För ytterligare information om våra produkter och lösningar besök vår webbplats [www.nskeurope.com](http://www.nskeurope.com).

### Anteckningar

- Även om alla ansträngningar har gjorts för att säkerställa riktigheten av de uppgifter som ingår i denna prislista kan utgivaren inte ansvara för innehållet.
  - Prislistan är giltig från den 1 Juli 2014 och ersätter alla tidigare utgivna prislistor.
  - Alla priser är exklusive moms.
  - När både NSK och RHP varumärken visas för ett liknande artikelnummer, se lämplig katalog för fullständig specifikation.
  - För att säkerställa att våra lager förblir i optimalt tillstånd under lagring och distribution, är vissa artiklar endast tillgängliga i minimivolymer t.ex. mindre spårkullager som levereras i förseglade förpackningar.
  - C3 glapp lager prissätts på samma sätt som lager med CN glapp. Vänligen kontakta din NSK Återförsäljare för andra glapp.
  - Observera att genom hela prislistan indikerar **M** mässingshållare. Om en speciell typ av mässinghållare krävs, vänligen kontakta ditt lokala NSK försäljningskontor.
  - Våra standardvillkor gäller.
-

**Contents**

Single Row Radial Ball Bearings - metric.....	1
Single Row Radial Ball Bearings - inch.....	31
Double Row Radial Ball Bearings.....	37
Double Row Self-Aligning Ball Bearings - metric.....	41
Single Row Angular Contact Ball Bearings - metric.....	51
Single Row Angular Contact Ball Bearings - inch.....	59
Double Row Angular Contact Ball Bearings.....	63
Thrust Ball Bearings - metric .....	69
Thrust Ball Bearings - inch .....	77
Cylindrical Roller Bearings - metric.....	81
Cylindrical Roller Bearings - inch .....	101
Spherical Roller Bearings .....	105
Tapered Roller Bearings - metric.....	117
Tapered Roller Bearings - inch .....	125
Super Precision Bearings.....	129
BSBD Ball Screw Support Bearings.....	145
RHP Self-Lube® and Silver-Lube®.....	149
NSK Housed Bearings.....	175
Plummer Blocks .....	185
Accessories .....	193
Linear Guides .....	200
Ballscrews .....	213
Support Units for ballscrews.....	221
Monocarrier .....	222
Megatorque Motor PS Serie.....	225

**Inhalt**

Einreihige Metrische Rillenkugellager.....	1
Einreihige Zöllige Rillenkugellager.....	31
Zweireihige Rillenkugellager.....	37
Zweireihige Metrische Pendelkugellager.....	41
Einreihige Metrische Schrägkugellager.....	51
Einreihige Zöllige Schrägkugellager .....	59
Zweireihiges Schrägkugellager .....	63
Metrische Axial-Rillenkugellager .....	69
Zöllige Axial-Rillenkugellager .....	77
Metrische Zylinderrollenlager .....	81
Zöllige Zylinderrollenlager .....	101
Pendelrollenlager.....	105
Metrische Kegelrollenlager.....	117
Zöllige Kegelrollenlager .....	125
Hochgenauigkeitslager.....	129
Axial-Schrägkugellager für Kugelgewindetriebe - BSBD-Serie .....	145
RHP Self-Lube® und Silver-Lube® Gehäuselager .....	149
NSK-Gehäuselager.....	175
Stehlagergehäuse.....	185
Zubehör .....	193
Linearführung .....	200
Kugelgewindetriebe.....	213
Lagerungen für Kugelgewindetriebe .....	221
Monocarrier .....	222
Megatorque Motor PS Serie.....	225



## Chapitres

Roulements rigides à une rangée de billes - métrique.....	1
Roulements rigides à une rangée de billes - pouce.....	31
Roulements rigides à deux rangée de billes - métrique.....	37
Roulements à deux rangées de billes auto-aligneurs - métrique.....	41
Roulements à une rangée de billes à contact oblique - métrique.....	51
Roulements à une rangée de billes à contact oblique - pouce.....	59
Roulements à deux rangées de billes à contact oblique .....	63
Butées à billes - métrique .....	69
Butées à billes - pouce.....	77
Roulements à rouleaux cylindriques - métrique.....	81
Roulements à rouleaux cylindriques - pouce.....	101
Roulements à rouleaux sphériques.....	105
oulements à rouleaux coniques - métrique.....	117
Roulements à rouleaux coniques - pouce.....	125
Roulements de Précision .....	129
Séries BSBD - Roulements Support de Vis à Billes.....	145
Roulements et paliers auto-aligneurs gamme Self-Lube® et anti-corrosion Silver-Lube®.....	149
Roulements et paliers auto-aligneurs gamme NSK .....	175
Paliers en deux parties.....	185
Accessoires.....	193
Guidages linéaires .....	200
Vis à billes.....	213
Unités support de vis à billes .....	221
Monocarrier .....	222
Megatorque Motor PS Serie.....	225

## Indice

Rodamientos de bolas de una hilera.....	1
Rodamientos de bolas de una hilera serie pulgadas .....	31
Rodamientos de bolas de doble hilera.....	37
Rodamientos de bolas autoalineantes de doble hilera .....	41
Rodamientos de contacto angular de una hilera .....	51
Rodamientos de contacto angular de una hilera serie pulgadash .....	59
Rodamientos de bolas de contacto angular de doble hilera .....	63
Rodamientos axiales de bolas .....	69
Rodamientos axiales de bolas serie pulgadas.....	77
Rodamientos de rodillos cilíndricos .....	81
Rodamientos de rodillos cilíndricos serie pulgadas.....	101
Rodamientos de rodillos esféricos.....	105
Rodamientos de rodillos cónicos.....	117
Rodamientos de rodillos cónicos serie pulgadas .....	125
Rodamientos de Superprecisión.....	129
Serie BSF/BSN – Rodamientos para Soportes de Husillos a Bolas .....	145
RHP Self-Lube® y Silver-Lube®.....	149
Pillow Blocks de NSK.....	175
Soportes Partidos (Plummer Blocks) .....	185
Accesorios.....	193
Guías lineales .....	200
Husillos a bolas .....	213
Soportes para husillos a bolas.....	221
Monocarrier .....	222
Megatorque Motor PS Serie.....	225

## Indice

Cuscinetti radiali rigidi a sfere, ad una corona .....	1
Cuscinetti radiali rigidi a sfere, ad una corona - dimensioni in pollici .....	31
Cuscinetti radiali rigidi a sfere, ad due corone .....	37
Cuscinetti radiali orientabili a sfere .....	41
Cuscinetti a sfere a contatto obliquo, ad una corona .....	51
Cuscinetti a sfere a contatto obliquo, ad una corona - dimensioni in pollici .....	59
Cuscinetti a sfere a contatto obliquo, ad due corone .....	63
Cuscinetti assiali a sfere .....	69
Cuscinetti assiali a sfere - dimensioni in pollici .....	77
Cuscinetti a rulli cilindrici .....	81
Cuscinetti a rulli cilindrici - dimensioni in pollici .....	101
Cuscinetti orientabili a due corone di rulli .....	105
Cuscinetti a rulli conici .....	117
Cuscinetti a rulli conici - dimensioni in pollici .....	125
Cuscinetti di Super Precisione .....	129
Cuscinetti per supporto di viti a ricircolazione di sfere della Serie BSBD .....	145
Supporti orientabili RHP Self-Lube® e supporti anticorrosione RHP Silver-Lube® .....	149
Supporti orientabili NSK .....	175
Supporti ritri in due metà .....	185
Accessori .....	193
Guide .....	200
Viti a ricirolo di sfere .....	213
Supporti per viti .....	221
Monocarrier .....	222
Megatorque Motor PS Serie .....	225

## Innehåll

Enradiga radialkullager - metriska .....	1
Enradiga radialkullager - tum .....	31
Tvåradiga radialkullager .....	37
Tvåradiga sfäriska kullager - metriska .....	41
Enradiga vinkelkontaktkullager - metriska .....	51
Enradiga vinkelkontaktkullager - tum .....	59
Tvåradiga vinkelkontaktkullager .....	63
Axialkullager - metriska .....	69
Axialkullager - tum .....	77
Cylindriska kullager - metriska .....	81
Cylindriska kullager - tum .....	101
Sfäriska rullager .....	105
Koniska rullager - metriska .....	117
Koniska rullager - tum .....	125
Högprecisionslager .....	129
BSBD Kulskruvslager - BSBD Serien .....	145
RHP Self-Lube® och Silver-Lube® .....	149
NSK kompletta lagerhus .....	175
Stållagerhus .....	185
Tillbehör .....	193
Linjärmodular .....	200
Kulskruvar .....	213
Lagerhus för kulskruvar .....	221
Monocarrier .....	222
Megatorque Motor PS Serie .....	225

**INDEX - INDICE (Bearing, Lager, Roulements, Rodamientos, Cuscinetti)**

100	43	3100-00	155	6300	16
1000-00	151	30200	119	6300TB	131
1100-00	153	30300	119	63000	16
11200	49	31300	120	6400	21
1200	43	3200	65	6800 (61800)	22
1200-00	154	32000	120	6900 (61900)	25
1300	44	32200	121	7000	53
1300-00	155	32300	122	7000P3	1321
16000	4	32900	122	7200	53
1726200	155	3300	66	7200P3	136
2200	46	33000	123	7300	55
2300	48	33100	123	7300P4	138
21300	107	33200	123	7400	57
22200	107	4200	39	7900P3	139
22300	109	4300	39	AEL	177
23000	111	5 - - A	187	AELPF	179
23100	112	51000	71	AELPFL	179
23200	113	52000	73	AH	194
23900	114	53000	74	AHX	194
24000	114	54000	76	AN	194
24100	115	600	3	AR	156
29200	115	6000	5	AS	177
29300	115	6000TC	131	ASPF	179
29400	116	6200	10	ASPFL	179
3000-00	155	6200TC	131	ASPP	179

**INDEX - INDICE (Bearing, Lager, Roulements, Rodamientos, Cuscinetti)**

A-UCS	177	LJT	61	NF400	92
AW	195	LPB	157	NJ200	83
BL	28	LPBR	158	NJ300	87
BO	27	LRJ	103	NJ400	92
BSB	143	LRJA	103	NJ2200	94
BSF	147	LZ3200	68	NJ2300	97
BSN	147	MFC	158	NN	144
BT	156	MFCD	159	NNCF	100
C KIT	188	MJ	35	NNU	144
CNP	156	MJT	61	NP	162
CS	177	MP	159	NU200	83
DNF	173	MPD	160	NU300	87
E	27	MRJ	104	NU400	92
EN	27	MRJA	104	NU1000	93
FC	156	MSC	160	NU2200	94
G KIT	189	MSF	160	NU2300	97
H	195	MSFT	160	NUP200	83
HE	196	MST	160	NUP300	88
J1000-00GCR	173	N200	83	NUP2200	94
KLNJ	33	N300	87	NUP2300	97
LB3200	68	N400	92	O	79
LF	157	N2200	95	- - P	173
LFG	157	NCF	99	P - - P	174
LFTC	157	NF200	83	PDF	173
LJ	34	NF300	87	PDFNF	173

**INDEX - INDICE (Bearing, Lager, Roulements, Rodamientos, Cuscinetti)**

PNP	173	T1000-00	155	UELF	182
PSF	174	T7000P3	143	UELFC	182
PSFT	174	T	172	UELFL	182
PST	174	TACK	188	UELP	182
R	33	TS	187	UELT	182
RLS	34	TSA	188	UK	178
RMS	35	TSM	188	UKC	182
RS-5000	100	UC	177	UKF	182
SCH	164	UCC	179	UKFC	183
SCHB	164	UCF	179	UKFL	183
SD	187	UCFA	179	UKP	183
SF	164	UCFC	180	UKT	183
SFT	166	UCFH	180	V KIT	189
SL	167	UCFL	180	XLJ	34
SLC	169	UCFS	180	XLRJA	103
SLFE	169	UCFX	180	Z-UC	183
SLFL	170	UCHB	181		
SLFT	170	UCHP	181		
SNN	187	UCP	181		
SNP	170	UCPX	181		
SR KIT	190	UCT	181		
SRC	171	UCTX	182		
SRM	171	UCUP	182		
ST	171	UCX	178		
-- TAC	143	UEL	178		



**Single Row Radial Ball Bearings - metric**

**Einreihige Metrische Rillenkugellager**

**Roulements rigides à une rangée de billes - métrique**

**Rodamientos de bolas de una hilera**

**Cuscinetti radiali rigidi a sfera, ad una corona**

**Enradiga radialkullager - metriska**

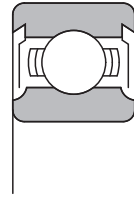
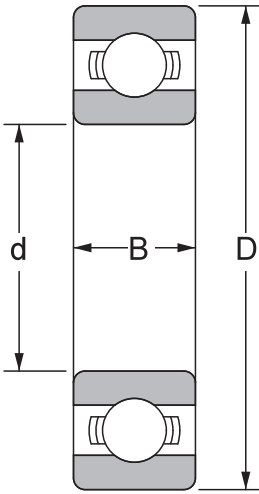

**ZZ**

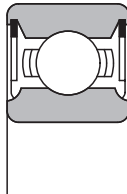

**DDU**

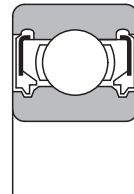

**VV**

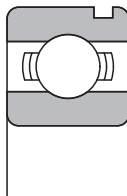

**N**

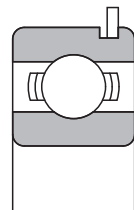

**NR**



Single Row Radial Ball Bearings - metric  
 Einreihige Metrische Rillenkugellager  
 Roulements rigides à une rangée de billes - métrique  
 Rodamientos de bolas de una hilera  
 Cuscinetti radiali rigidi a sfera, ad una corona  
 Enradiga radiallykullager - metriskä

NSK	RHP	d	D	B	€
604ZZ	-	4	12	4	19.33
605ZZ	-	5	14	5	19.39
606ZZ	-	6	17	6	19.64
606DD	-	6	17	6	22.29
606VV	-	6	17	6	22.29
607	-	7	19	6	7.49
607ZZ	-	7	19	6	7.97
607DD	-	7	19	6	8.97
607VV	-	7	19	6	10.44
608	-	8	22	7	6.85
608Z	-	8	22	7	9.21
608ZZ	-	8	22	7	7.92
608DD	-	8	22	7	8.94
609	-	9	24	7	7.98
609ZZ	-	9	24	7	8.22
609DD	-	9	24	7	9.30
609VV	-	9	24	7	10.53
623	-	3	10	4	10.00
623ZZ	-	3	10	4	10.37
624ZZ	-	4	13	5	8.98
625	-	5	16	5	7.58
625ZZ	-	5	16	5	7.97
625DD	-	5	16	5	9.05
626	-	6	19	6	7.01
626Z	-	6	19	6	8.83
626ZZ	-	6	19	6	7.84
626DD	-	6	19	6	8.92
626VV	-	6	19	6	10.03
627	-	7	22	7	7.50
627ZZ	-	7	22	7	7.75
627DD	-	7	22	7	8.78
627VV	-	7	22	7	9.85
628ZZ	-	8	24	8	18.63
628DD	-	8	24	8	21.17
629	-	9	26	8	8.08
629ZZ	-	9	26	8	8.37
629DD	-	9	26	8	9.43
629VV	-	9	26	8	10.23
634ZZ	-	4	16	5	10.78
635ZZ	-	5	19	6	9.05

Single Row Radial Ball Bearings - metric  
 Einreihige Metrische Rillenkugellager  
 Roulements rigides à une rangée de billes - métrique  
 Rodamientos de bolas de una hilera  
 Cuscinetti radiali rigidi a sfera, ad una corona  
 Enradiga radialkullager - metriská

NSK	RHP	d	D	B	€
635DD	-	5	19	6	10.26
635VV	-	5	19	6	10.95
638ZZ	-	8	28	9	22.09
684ZZ	-	4	9	4	18.56
685	-	5	11	3	15.16
685ZZ	-	5	11	5	18.18
686ZZ	-	6	13	5	18.18
686DD	-	6	13	5	21.23
687ZZ	-	7	14	5	18.18
688ZZ	-	8	16	5	19.01
688VV	-	8	16	5	22.14
689ZZ	-	9	17	5	19.78
692ZZ	-	2	6	3	14.00
693ZZ	-	3	8	4	14.00
694ZZ	-	4	11	4	19.65
695ZZ	-	5	13	4	18.99
696ZZ	-	6	15	5	18.99
696DD	-	6	15	5	21.23
697ZZ	-	7	17	5	19.28
698ZZ	-	8	19	6	19.80
698DD	-	8	19	6	22.47
699DD	-	9	20	6	23.85
16001	-	12	28	7	15.03
16002	-	15	32	8	15.06
16003	-	17	35	8	15.54
16004	-	20	42	8	16.21
16005	-	25	47	8	17.81
16006	-	30	55	9	23.50
16007	-	35	62	9	24.07
16008	-	40	68	9	27.96
16009	-	45	75	10	38.30
16010	-	50	80	10	41.18
16011	-	55	90	11	55.99
16012	-	60	95	11	63.78
16013	-	65	100	11	74.23
16014	-	70	110	13	90.79
16015	-	75	115	13	100.94
16016	-	80	125	14	118.20
16017	-	85	130	14	129.05
16018	-	90	140	16	147.98

Single Row Radial Ball Bearings - metric  
 Einreihige Metrische Rillenkugellager  
 Roulements rigides à une rangée de billes - métrique  
 Rodamientos de bolas de una hilera  
 Cuscinetti radiali rigidi a sfera, ad una corona  
 Enradiga radiallykullager - metriskä

NSK	RHP	d	D	B	€
16019	-	95	145	16	177.71
16020	-	100	150	16	183.00
16021	-	105	160	18	221.50
16022	-	110	170	19	256.40
16024	-	120	180	19	299.54
16026	-	130	200	22	406.90
16028M	-	140	210	22	916.16
16030	-	150	225	24	568.95
16030M	-	150	225	24	910.28
16032M	-	160	240	25	1070.01
16034M	-	170	260	28	1297.34
16036M	-	180	280	31	1413.20
16038M	-	190	290	31	1555.56
16040M	-	200	310	34	1617.64
16044M	-	220	340	37	2053.50
16048M	-	240	360	37	3170.48
16060M	-	300	460	50	10338.42
16100	-	10	28	8	15.81
16101	-	12	30	8	15.78
6000	-	10	26	8	7.50
6000ZZ	-	10	26	8	8.61
6000ZZNR	-	10	26	8	12.72
6000D	-	10	26	8	9.85
6000DDU	-	10	26	8	9.77
6000VV	-	10	26	8	11.46
6001	-	12	28	8	8.05
6001Z	-	12	28	8	10.62
6001ZZ	-	12	28	8	9.28
6001DU	-	12	28	8	12.30
6001DDU	-	12	28	8	10.49
6001VV	-	12	28	8	12.30
6002	-	15	32	9	8.82
6002Z	-	15	32	9	11.89
6002ZZ	-	15	32	9	10.17
6002ZZNR	-	15	32	9	15.02
6002DU	-	15	32	9	13.47
6002DDU	-	15	32	9	11.52
6002DDUNR	-	15	32	9	16.98
6002VV	-	15	32	9	13.47
6003	-	17	35	10	9.29

Single Row Radial Ball Bearings - metric  
 Einreihige Metrische Rillenkugellager  
 Roulements rigides à une rangée de billes - métrique  
 Rodamientos de bolas de una hilera  
 Cuscinetti radiali rigidi a sfera, ad una corona  
 Enradiga radialkullager - metriska

NSK	RHP	d	D	B	€
6003NR	-	17	35	10	13.76
6003Z	-	17	35	10	12.51
6003ZZ	-	17	35	10	10.69
6003ZZNR	-	17	35	10	15.78
6003DU	-	17	35	10	14.17
6003DDU	-	17	35	10	12.09
6003DDUNR	-	17	35	10	17.88
6003VV	-	17	35	10	14.17
6004	-	20	42	12	10.32
6004NR	-	20	42	12	15.22
6004Z	-	20	42	12	13.30
6004ZZ	-	20	42	12	11.87
6004ZZNR	-	20	42	12	18.37
6004DU	-	20	42	12	15.73
6004DDU	-	20	42	12	13.41
6004DDUNR	-	20	42	12	22.50
6004VV	-	20	42	12	15.73
60/22	-	22	44	12	18.79
60/22DDU	-	22	44	12	24.46
60/22ZZ	-	22	44	12	22.53
6005	-	25	47	12	11.85
6005NR	-	25	47	12	20.84
6005Z	-	25	47	12	15.54
6005ZNR	-	25	47	12	20.74
6005ZZ	-	25	47	12	13.59
6005ZZNR	-	25	47	12	21.00
6005DU	-	25	47	12	18.02
6005DDU	-	25	47	12	15.41
6005DDUNR	-	25	47	12	24.96
6005VV	-	25	47	12	18.02
60/28	-	28	52	12	22.59
60/28AZZ	-	28	52	12	28.99
60/28DD	-	28	52	12	31.63
6006Z	-	30	55	13	19.45
6006ZZNR	-	30	55	13	24.60
6006DU	-	30	55	13	22.01
6006DDU	-	30	55	13	18.90
6006DDUNR	-	30	55	13	30.17
6006VV	-	30	55	13	21.49
60/32	-	32	58	13	35.94

Single Row Radial Ball Bearings - metric  
 Einreihige Metrische Rillenkugellager  
 Roulements rigides à une rangée de billes - métrique  
 Rodamientos de bolas de una hilera  
 Cuscinetti radiali rigidi a sfera, ad una corona  
 Enradiga radiallykullager - metriskä

NSK	RHP	d	D	B	€
60/32DDU	-	32	58	13	50.31
60/32ZZ	-	32	58	13	43.14
6007	-	35	62	14	17.99
6007NR	-	35	62	14	26.52
6007Z	-	35	62	14	24.12
6007ZNR	-	35	62	14	31.35
6007ZZ	-	35	62	14	20.69
6007ZZNR	-	35	62	14	30.47
6007DU	-	35	62	14	27.31
6007DDU	-	35	62	14	23.42
6007DDUNR	-	35	62	14	45.19
6007VV	-	35	62	14	26.52
6008	-	40	68	15	22.62
6008NR	-	40	68	15	34.91
6008Z	-	40	68	15	30.34
6008ZNR	-	40	68	15	39.43
6008ZZ	-	40	68	15	26.05
6008ZZNR	-	40	68	15	38.30
6008DU	-	40	68	15	34.32
6008DDU	-	40	68	15	29.45
6008DDUNR	-	40	68	15	43.31
6008VV	-	40	68	15	33.34
6009	-	45	75	16	29.41
6009NR	-	45	75	16	44.98
6009Z	-	45	75	16	39.38
6009ZNR	-	45	75	16	51.17
6009ZZ	-	45	75	16	33.80
6009DDU	-	45	75	16	38.22
6009DDUNR	-	45	75	16	56.23
6009VV	-	45	75	16	43.24
6010	-	50	80	16	34.06
6010NR	-	50	80	16	54.94
6010Z	-	50	80	16	45.67
6010ZZ	-	50	80	16	39.18
6010ZZNR	-	50	80	16	57.69
6010DU	-	50	80	16	51.69
6010DDU	-	50	80	16	44.34
6010DDUNR	-	50	80	16	65.19
6010VV	-	50	80	16	50.18
6011	-	55	90	18	43.54

Single Row Radial Ball Bearings - metric  
 Einreihige Metrische Rillenkugellager  
 Roulements rigides à une rangée de billes - métrique  
 Rodamientos de bolas de una hilera  
 Cuscinetti radiali rigidi a sfera, ad una corona  
 Enradiga radialkullager - metriska

NSK	RHP	d	D	B	€
6011M	-	55	90	18	186.46
6011NR	-	55	90	18	67.10
6011Z	-	55	90	18	58.33
6011ZZ	-	55	90	18	50.77
6011ZZNR	-	55	90	18	73.67
6011DU	-	55	90	18	70.70
6011DDU	-	55	90	18	56.63
6011DDUNR	-	55	90	18	83.27
6011VV	-	55	90	18	64.09
6012	-	60	95	18	49.94
6012M	-	60	95	18	257.67
6012NR	-	60	95	18	80.42
6012ZNR	-	60	95	18	86.98
6012ZZ	-	60	95	18	57.40
6012ZZNR	-	60	95	18	84.49
6012DU	-	60	95	18	75.51
6012DDU	-	60	95	18	64.80
6012DDUNR	-	60	95	18	95.34
6012VV	-	60	95	18	73.34
6013	-	65	100	18	65.84
6013NR	-	65	100	18	90.45
6013Z	-	65	100	18	82.60
6013ZNR	-	65	100	18	105.33
6013ZZ	-	65	100	18	76.22
6013ZZNR	-	65	100	18	99.88
6013DU	-	65	100	18	92.58
6013DDU	-	65	100	18	83.23
6013DDUNR	-	65	100	18	113.53
6013VV	-	65	100	18	86.42
6014	-	70	110	20	84.10
6014M	-	70	110	20	326.43
6014NR	-	70	110	20	111.60
6014Z	-	70	110	20	102.92
6014ZNR	-	70	110	20	133.83
6014ZZ	-	70	110	20	96.76
6014ZZNR	-	70	110	20	126.87
6014DU	-	70	110	20	124.66
6014DDU	-	70	110	20	105.71
6014VV	-	70	110	20	109.76
6015	-	75	115	20	96.30

Single Row Radial Ball Bearings - metric  
 Einreihige Metrische Rillenkugellager  
 Roulements rigides à une rangée de billes - métrique  
 Rodamientos de bolas de una hilera  
 Cuscinetti radiali rigidi a sfera, ad una corona  
 Enradiga radiallykullager - metriská

NSK	RHP	d	D	B	€
6015M	-	75	115	20	368.39
6015NR	-	75	115	20	142.15
6015Z	-	75	115	20	117.77
6015ZNR	-	75	115	20	153.13
6015ZZ	-	75	115	20	110.69
6015DU	-	75	115	20	142.80
6015DDU	-	75	115	20	121.13
6015VV	-	75	115	20	125.76
6016	-	80	125	22	117.15
6016NR	-	80	125	22	157.40
6016Z	-	80	125	22	143.52
6016ZZ	-	80	125	22	134.88
6016DDU	-	80	125	22	146.99
6017	-	85	130	22	131.37
6017NR	-	85	130	22	175.64
6017Z	-	85	130	22	172.05
6017ZZ	-	85	130	22	150.89
6017DDU	-	85	130	22	170.67
6017VV	-	85	130	22	176.34
6018	-	90	140	24	156.12
6018NR	-	90	140	24	269.77
6018Z	-	90	140	24	190.91
6018ZNR	-	90	140	24	248.16
6018ZZ	-	90	140	24	179.45
6018DDU	-	90	140	24	202.92
6018VV	-	90	140	24	209.68
6019	-	95	145	24	181.18
6019Z	-	95	145	24	230.77
6019ZZ	-	95	145	24	213.49
6019DDU	-	95	145	24	235.47
6020	-	100	150	24	199.23
6020NR	-	100	150	24	284.35
6020Z	-	100	150	24	243.69
6020ZZ	-	100	150	24	234.66
6020DU	-	100	150	24	295.33
6020DDU	-	100	150	24	250.50
6020VV	-	100	150	24	260.10
6021	-	105	160	26	246.52
6021ZZ	-	105	160	26	294.58
6021DDU	-	105	160	26	332.98

Single Row Radial Ball Bearings - metric  
 Einreihige Metrische Rillenkugellager  
 Roulements rigides à une rangée de billes - métrique  
 Rodamientos de bolas de una hilera  
 Cuscinetti radiali rigidi a sfera, ad una corona  
 Enradiga radialkullager - metriska

NSK	RHP	d	D	B	€
6022	-	110	170	28	295.72
6022NR	-	110	170	28	428.03
6022Z	-	110	170	28	356.64
6022ZZ	-	110	170	28	353.58
6022DDU	-	110	170	28	396.32
6024	-	120	180	28	336.69
6024M	-	120	180	28	732.65
6024Z	-	120	180	28	426.12
6024ZZ	-	120	180	28	412.39
6024DDU	-	120	180	28	437.67
6026	-	130	200	33	449.06
6026ZZ	-	130	200	33	571.64
6026DDU	-	130	200	33	666.13
6028	-	140	210	33	525.17
6028ZZ	-	140	210	33	654.98
6028DDU	-	140	210	33	762.99
6030	-	150	225	35	639.94
6030M	-	150	225	35	987.06
6030ZZ	-	150	225	35	798.06
6030DDU	-	150	225	35	922.37
6032	-	160	240	38	1087.25
6032M	-	160	240	38	1153.88
6032DDU	-	160	240	38	1577.47
6034	-	170	260	42	1335.08
6034M	-	170	260	42	1366.85
6036	-	180	280	46	1520.79
6036M	-	180	280	46	1556.99
6038	-	190	290	46	1732.85
6038M	-	190	290	46	1774.10
6040	-	200	310	51	2001.00
6040M	-	200	310	51	2048.65
6044M	-	220	340	56	2808.69
6048M	-	240	360	56	3437.51
6052M	-	260	400	65	5270.30
6056M	-	280	420	65	6567.19
6200	-	10	30	9	7.51
6200NR	-	10	30	9	11.10
6200Z	-	10	30	9	10.13
6200ZNR	-	10	30	9	13.18
6200ZZ	-	10	30	9	8.67



Single Row Radial Ball Bearings - metric  
 Einreihige Metrische Rillenkugellager  
 Roulements rigides à une rangée de billes - métrique  
 Rodamientos de bolas de una hilera  
 Cuscinetti radiali rigidi a sfera, ad una corona  
 Enradiga radiallykullager - metriskä

NSK	RHP	d	D	B	€
6200ZZNR	-	10	30	9	14.62
6200DU	-	10	30	9	11.47
6200DDU	-	10	30	9	9.78
6200DDUNR	-	10	30	9	14.45
6200VV	-	10	30	9	11.47
6201	-	12	32	10	7.84
6201NR	-	12	32	10	12.71
6201Z	-	12	32	10	10.56
6201ZNR	-	12	32	10	13.78
6201ZZ	-	12	32	10	9.01
6201ZZNR	-	12	32	10	16.00
6201DU	-	12	32	10	11.93
6201DDU	-	12	32	10	10.19
6201DDUNR	-	12	32	10	15.05
6201VV	-	12	32	10	11.93
6202	-	15	35	11	8.45
6202NR	-	15	35	11	15.91
6202Z	-	15	35	11	11.39
6202ZNR	-	15	35	11	14.80
6202ZZ	-	15	35	11	9.73
6202ZZNR	-	15	35	11	16.35
6202DU	-	15	35	11	12.88
6202DDU	-	15	35	11	11.00
6202DDUNR	-	15	35	11	19.03
6202VV	-	15	35	11	12.88
6203	-	17	40	12	9.52
6203NR	-	17	40	12	14.04
6203Z	-	17	40	12	12.76
6203ZNR	-	17	40	12	16.60
6203ZZ	-	17	40	12	10.90
6203ZZNR	-	17	40	12	16.15
6203DU	-	17	40	12	14.45
6203DDU	-	17	40	12	12.36
6203DDUNR	-	17	40	12	20.01
6203VV	-	17	40	12	14.45
6204	-	20	47	14	11.16
6204NR	-	20	47	14	19.98
6204Z	-	20	47	14	14.92
6204ZNR	-	20	47	14	19.36
6204ZZ	-	20	47	14	12.71

Single Row Radial Ball Bearings - metric  
 Einreihige Metrische Rillenkugellager  
 Roulements rigides à une rangée de billes - métrique  
 Rodamientos de bolas de una hilera  
 Cuscinetti radiali rigidi a sfera, ad una corona  
 Enradiga radialkullager - metriská

NSK	RHP	d	D	B	€
6204ZZNR	-	20	47	14	20.75
6204DU	-	20	47	14	17.01
6204DDU	-	20	47	14	14.51
6204DDUNR	-	20	47	14	23.53
6204VV	-	20	47	14	17.01
62/22	-	22	50	14	24.06
62/22ZZ	-	22	50	14	30.33
62/22DDU	-	22	50	14	24.31
6205	-	25	52	15	13.01
6205NR	-	25	52	15	22.77
6205Z	-	25	52	15	17.57
6205ZNR	-	25	52	15	21.62
6205ZZ	-	25	52	15	14.97
6205ZZNR	-	25	52	15	24.73
6205DU	-	25	52	15	19.82
6205DDU	-	25	52	15	16.97
6205DDUNR	-	25	52	15	27.30
6205VV	-	25	52	15	19.82
62205DDU	-	25	52	18	35.70
62/28	-	28	58	16	24.84
62/28NR	-	28	58	16	32.29
62/28ZNR	-	28	58	16	37.15
62/28ZZ	-	28	58	16	28.58
62/28DDU	-	28	58	16	29.61
6206	-	30	62	16	17.44
6206Z	-	30	62	16	22.79
6206ZNR	-	30	62	16	32.76
6206ZZNR	-	30	62	16	39.38
6206DDU	-	30	62	16	22.62
6206DDUNR	-	30	62	16	34.39
62/32	-	32	65	17	28.40
62/32DDU	-	32	65	17	36.91
6207	-	35	72	17	22.97
6207NR	-	35	72	17	37.59
6207Z	-	35	72	17	30.77
6207ZNR	-	35	72	17	42.32
6207ZZ	-	35	72	17	26.42
6207DU	-	35	72	17	34.74
6207DDU	-	35	72	17	29.85
6207VV	-	35	72	17	33.76

Single Row Radial Ball Bearings - metric  
 Einreihige Metrische Rillenkugellager  
 Roulements rigides à une rangée de billes - métrique  
 Rodamientos de bolas de una hilera  
 Cuscinetti radiali rigidi a sfera, ad una corona  
 Enradiga radiallykullager - metriskä

NSK	RHP	d	D	B	€
6208	-	40	80	18	30.39
6208NR	-	40	80	18	48.02
6208Z	-	40	80	18	40.01
6208ZNR	-	40	80	18	54.27
6208ZZ	-	40	80	18	35.00
6208DU	-	40	80	18	46.04
6208DDU	-	40	80	18	39.50
6208DDUNR	-	40	80	18	58.90
6208VV	-	40	80	18	44.70
6209	-	45	85	19	37.14
6209M	-	45	85	19	199.79
6209NR	-	45	85	19	57.18
6209Z	-	45	85	19	49.79
6209ZNR	-	45	85	19	64.74
6209ZZ	-	45	85	19	42.75
6209ZZNR	-	45	85	19	62.86
6209DU	-	45	85	19	56.25
6209DDU	-	45	85	19	48.26
6209DDUNR	-	45	85	19	87.28
6209VV	-	45	85	19	54.62
6210	-	50	90	20	44.00
6210M	-	50	90	20	223.90
6210NR	-	50	90	20	66.13
6210Z	-	50	90	20	58.89
6210ZNR	-	50	90	20	63.57
6210ZZ	-	50	90	20	50.55
6210ZZNR	-	50	90	20	69.14
6210DU	-	50	90	20	66.59
6210DDU	-	50	90	20	57.15
6210DDUNR	-	50	90	20	108.60
6210VV	-	50	90	20	64.67
6211	-	55	100	21	51.94
6211M	-	55	100	21	250.23
6211NR	-	55	100	21	77.45
6211Z	-	55	100	21	69.65
6211ZNR	-	55	100	21	94.11
6211ZZ	-	55	100	21	59.75
6211ZZNR	-	55	100	21	87.95
6211DU	-	55	100	21	78.64
6211DDU	-	55	100	21	67.47

Single Row Radial Ball Bearings - metric  
 Einreihige Metrische Rillenkugellager  
 Roulements rigides à une rangée de billes - métrique  
 Rodamientos de bolas de una hilera  
 Cuscinetti radiali rigidi a sfera, ad una corona  
 Enradiga radialkullager - metriska

NSK	RHP	d	D	B	€
6211DDUNR	-	55	100	21	127.41
6211VV	-	55	100	21	76.38
6212	-	60	110	22	64.61
6212M	-	60	110	22	276.37
6212NR	-	60	110	22	93.67
6212Z	-	60	110	22	84.83
6212ZNR	-	60	110	22	113.86
6212ZZ	-	60	110	22	74.24
6212ZZNR	-	60	110	22	107.16
6212DU	-	60	110	22	96.01
6212DDU	-	60	110	22	84.03
6212DDUNR	-	60	110	22	132.75
6212VV	-	60	110	22	93.25
6213	-	65	120	23	98.42
6213M	-	65	120	23	315.02
6213NR	-	65	120	23	134.91
6213Z	-	65	120	23	119.39
6213ZNR	-	65	120	23	163.88
6213ZZ	-	65	120	23	115.96
6213DU	-	65	120	23	141.55
6213DDU	-	65	120	23	124.71
6213VV	-	65	120	23	127.75
6214	-	70	125	24	112.16
6214M	-	70	125	24	392.94
6214NR	-	70	125	24	150.14
6214Z	-	70	125	24	132.83
6214ZNR	-	70	125	24	172.64
6214ZZ	-	70	125	24	132.83
6214DU	-	70	125	24	160.70
6214DDU	-	70	125	24	141.54
6214VV	-	70	125	24	141.54
6215	-	75	130	25	132.53
6215M	-	75	130	25	472.26
6215NR	-	75	130	25	177.46
6215Z	-	75	130	25	168.42
6215ZNR	-	75	130	25	218.97
6215ZZ	-	75	130	25	157.14
6215DU	-	75	130	25	190.19
6215DDU	-	75	130	25	167.46
6215VV	-	75	130	25	169.10

Single Row Radial Ball Bearings - metric  
 Einreihige Metrische Rillenkugellager  
 Roulements rigides à une rangée de billes - métrique  
 Rodamientos de bolas de una hilera  
 Cuscinetti radiali rigidi a sfera, ad una corona  
 Enradiga radiallykullager - metriská

NSK	RHP	d	D	B	€
6216	-	80	140	26	155.17
6216M	-	80	140	26	550.34
6216NR	-	80	140	26	201.68
6216Z	-	80	140	26	183.90
6216ZNR	-	80	140	26	239.19
6216ZZ	-	80	140	26	183.90
6216DDU	-	80	140	26	196.01
6216DDUNR	-	80	140	26	262.20
6216VV	-	80	140	26	201.68
6217	-	85	150	28	194.71
6217NR	-	85	150	28	253.25
6217Z	-	85	150	28	224.28
6217ZNR	-	85	150	28	291.58
6217ZZ	-	85	150	28	224.28
6217DU	-	85	150	28	253.02
6217DDU	-	85	150	28	253.02
6218	-	90	160	30	234.50
6218M	-	90	160	30	503.36
6218NR	-	90	160	30	297.14
6218Z	-	90	160	30	296.24
6218ZZ	-	90	160	30	276.43
6218DDU	-	90	160	30	312.15
6219	-	95	170	32	283.24
6219NR	-	95	170	32	377.00
6219Z	-	95	170	32	357.44
6219ZZ	-	95	170	32	333.47
6219DDU	-	95	170	32	402.54
6220	-	100	180	34	325.52
6220NR	-	100	180	34	423.05
6220Z	-	100	180	34	383.26
6220ZZ	-	100	180	34	383.26
6220DDU	-	100	180	34	422.81
6221	-	105	190	36	412.83
6221ZZ	-	105	190	36	507.97
6221DDU	-	105	190	36	536.92
6222	-	110	200	38	472.26
6222M	-	110	200	38	1000.13
6222ZZ	-	110	200	38	597.82
6222DDU	-	110	200	38	632.24
6224	-	120	215	40	605.79

Single Row Radial Ball Bearings - metric  
 Einreihige Metrische Rillenkugellager  
 Roulements rigides à une rangée de billes - métrique  
 Rodamientos de bolas de una hilera  
 Cuscinetti radiali rigidi a sfera, ad una corona  
 Enradiga radialkullager - metriska

NSK	RHP	d	D	B	€
6224ZZ	-	120	215	40	717.24
6224DDU	-	120	215	40	810.96
6226	-	130	230	40	732.96
6226ZZ	-	130	230	40	867.83
6228	-	140	250	42	990.93
6228M	-	140	250	42	1409.25
6230	-	150	270	45	1179.87
6230M	-	150	270	45	1659.53
6232	-	160	290	48	1833.26
6232M	-	160	290	48	1876.91
6234	-	170	310	52	2183.88
6234M	-	170	310	52	2235.86
6236	-	180	320	52	2584.53
6236M	-	180	320	52	2646.07
6238	-	190	340	55	3152.10
6238M	-	190	340	55	3227.15
6240M	-	200	360	58	3836.43
6244M	-	220	400	65	5762.39
6300	-	10	35	11	10.79
6300Z	-	10	35	11	14.38
6300ZZ	-	10	35	11	11.43
6300DU	-	10	35	11	16.22
6300DDU	-	10	35	11	12.93
6300VV	-	10	35	11	14.70
6301	-	12	37	12	11.07
6301Z	-	12	37	12	13.76
6301ZZ	-	12	37	12	11.73
6301DU	-	12	37	12	16.69
6301DDU	-	12	37	12	13.28
6301VV	-	12	37	12	15.11
63001DDU	-	12	28	12	26.11
6302	-	15	42	13	11.10
6302Z	-	15	42	13	14.94
6302ZZ	-	15	42	13	12.75
6302ZZNR	-	15	42	13	18.83
6302DU	-	15	42	13	16.84
6302DDU	-	15	42	13	14.40
6302VV	-	15	42	13	16.39
6303	-	17	47	14	12.54
6303NR	-	17	47	14	18.54

Single Row Radial Ball Bearings - metric  
 Einreihige Metrische Rillenkugellager  
 Roulements rigides à une rangée de billes - métrique  
 Rodamientos de bolas de una hilera  
 Cuscinetti radiali rigidi a sfera, ad una corona  
 Enradiga radiallykullager - metriskä

NSK	RHP	d	D	B	€
6303Z	-	17	47	14	16.84
6303ZZ	-	17	47	14	14.40
6303ZZNR	-	17	47	14	21.33
6303DU	-	17	47	14	20.46
6303DDU	-	17	47	14	16.29
6303VV	-	17	47	14	18.54
6304	-	20	52	15	14.51
6304NR	-	20	52	15	36.98
6304Z	-	20	52	15	19.55
6304ZNR	-	20	52	15	25.42
6304ZZ	-	20	52	15	16.71
6304ZZNR	-	20	52	15	36.17
6304DU	-	20	52	15	22.09
6304DDU	-	20	52	15	18.87
6304DDUNR	-	20	52	15	40.43
6304VV	-	20	52	15	21.46
63/22	-	22	56	16	41.16
63/22NR	-	22	56	16	35.70
63/22DDU	-	22	56	16	35.70
6305	-	25	62	17	18.26
6305N	-	25	62	17	30.81
6305NR	-	25	62	17	30.21
6305Z	-	25	62	17	24.47
6305ZNR	-	25	62	17	36.41
6305ZZ	-	25	62	17	20.99
6305ZZNR	-	25	62	17	36.79
6305DU	-	25	62	17	27.62
6305DDU	-	25	62	17	23.76
6305DDUNR	-	25	62	17	35.94
6305VV	-	25	62	17	26.88
63/28	-	28	68	18	41.74
63/28N	-	28	68	18	54.29
63/28NR	-	28	68	18	54.29
63/28ZZ	-	28	68	18	50.09
6306	-	30	72	19	24.54
6306N	-	30	72	19	36.61
6306NR	-	30	72	19	39.58
6306ZNR	-	30	72	19	44.57
6306ZZ	-	30	72	19	28.25
6306ZZNR	-	30	72	19	54.43

Single Row Radial Ball Bearings - metric  
 Einreihige Metrische Rillenkugellager  
 Roulements rigides à une rangée de billes - métrique  
 Rodamientos de bolas de una hilera  
 Cuscinetti radiali rigidi a sfera, ad una corona  
 Enradiga radialkullager - metriska

NSK	RHP	d	D	B	€
6306DU	-	30	72	19	37.18
6306DDU	-	30	72	19	31.88
6306DDUNR	-	30	72	19	46.93
6306VV	-	30	72	19	36.08
63/32	-	32	75	20	44.23
63/32N	-	32	75	20	57.49
63/32NR	-	32	75	20	57.49
63/32ZNR	-	32	75	20	68.95
63/32ZZ	-	32	75	20	53.06
63/32DDU	-	32	75	20	57.49
63/32DDUNR	-	32	75	20	74.71
6307	-	35	80	21	33.01
6307M	-	35	80	21	141.62
6307NR	-	35	80	21	51.28
6307Z	-	35	80	21	44.23
6307ZNR	-	35	80	21	57.98
6307ZZ	-	35	80	21	37.94
6307ZZNR	-	35	80	21	63.11
6307DU	-	35	80	21	50.00
6307DDU	-	35	80	21	42.89
6307DDUNR	-	35	80	21	63.11
6307VV	-	35	80	21	48.54
6308	-	40	90	23	46.67
6308M	-	40	90	23	166.76
6308NR	-	40	90	23	70.69
6308Z	-	40	90	23	62.49
6308ZNR	-	40	90	23	80.06
6308ZZ	-	40	90	23	53.63
6308ZZNR	-	40	90	23	78.97
6308DU	-	40	90	23	70.70
6308DDU	-	40	90	23	60.70
6308DDUNR	-	40	90	23	89.29
6308VV	-	40	90	23	68.71
6309	-	45	100	25	58.90
6309M	-	45	100	25	211.47
6309NR	-	45	100	25	86.04
6309Z	-	45	100	25	78.86
6309ZNR	-	45	100	25	97.68
6309ZZ	-	45	100	25	67.66
6309ZZNR	-	45	100	25	126.84



Single Row Radial Ball Bearings - metric  
 Einreihige Metrische Rillenkugellager  
 Roulements rigides à une rangée de billes - métrique  
 Rodamientos de bolas de una hilera  
 Cuscinetti radiali rigidi a sfera, ad una corona  
 Enradiga radiallykullager - metriská

NSK	RHP	d	D	B	€
6309DU	-	45	100	25	89.22
6309DDUNR	-	45	100	25	107.76
6309VV	-	45	100	25	86.64
6310	-	50	110	27	78.11
6310M	-	50	110	27	217.66
6310NR	-	50	110	27	110.23
6310Z	-	50	110	27	102.67
6310ZNR	-	50	110	27	134.32
6310ZZ	-	50	110	27	89.86
6310ZZNR	-	50	110	27	141.98
6310DU	-	50	110	27	116.11
6310DDU	-	50	110	27	101.61
6310DDUNR	-	50	110	27	160.63
6310VV	-	50	110	27	112.77
6311	-	55	120	29	98.04
6311M	-	55	120	29	278.62
6311NR	-	55	120	29	142.16
6311Z	-	55	120	29	128.61
6311ZNR	-	55	120	29	172.29
6311ZZ	-	55	120	29	112.55
6311ZZNR	-	55	120	29	162.36
6311DU	-	55	120	29	155.76
6311DDU	-	55	120	29	127.17
6311DDUNR	-	55	120	29	183.44
6311VV	-	55	120	29	141.14
6312	-	60	130	31	124.24
6312M	-	60	130	31	315.02
6312NR	-	60	130	31	175.85
6312Z	-	60	130	31	157.00
6312ZNR	-	60	130	31	214.41
6312ZZ	-	60	130	31	143.04
6312ZZNR	-	60	130	31	206.40
6312DU	-	60	130	31	197.66
6312DDU	-	60	130	31	161.41
6312DDUNR	-	60	130	31	233.04
6312VV	-	60	130	31	179.14
6313	-	65	140	33	177.88
6313M	-	65	140	33	403.37
6313NR	-	65	140	33	229.10
6313Z	-	65	140	33	216.79

Single Row Radial Ball Bearings - metric  
 Einreihige Metrische Rillenkugellager  
 Roulements rigides à une rangée de billes - métrique  
 Rodamientos de bolas de una hilera  
 Cuscinetti radiali rigidi a sfera, ad una corona  
 Enradiga radialkullager - metriska

NSK	RHP	d	D	B	€
6313ZNR	-	65	140	33	281.91
6313ZZ	-	65	140	33	204.63
6313ZZNR	-	65	140	33	255.79
6313DU	-	65	140	33	262.21
6313DDU	-	65	140	33	230.96
6313VV	-	65	140	33	230.96
6314	-	70	150	35	213.55
6314M	-	70	150	35	482.06
6314NR	-	70	150	35	280.00
6314Z	-	70	150	35	260.40
6314ZNR	-	70	150	35	338.45
6314ZZ	-	70	150	35	245.78
6314ZZNR	-	70	150	35	328.74
6314DU	-	70	150	35	352.83
6314DDU	-	70	150	35	277.83
6314VV	-	70	150	35	277.83
6315	-	75	160	37	253.15
6315M	-	75	160	37	569.74
6315Z	-	75	160	37	308.77
6315ZZ	-	75	160	37	301.42
6315DU	-	75	160	37	348.95
6315DDU	-	75	160	37	338.94
6315VV	-	75	160	37	338.94
6316	-	80	170	39	299.52
6316M	-	80	170	39	589.25
6316NR	-	80	170	39	412.45
6316Z	-	80	170	39	391.30
6316ZZ	-	80	170	39	354.60
6316DDU	-	80	170	39	412.46
6316VV	-	80	170	39	412.46
6317	-	85	180	41	352.42
6317Z	-	85	180	41	471.28
6317ZZ	-	85	180	41	429.25
6317DDU	-	85	180	41	531.15
6318	-	90	190	43	438.14
6318M	-	90	190	43	984.19
6318Z	-	90	190	43	573.02
6318ZZ	-	90	190	43	534.65
6318DDU	-	90	190	43	604.02
6319	-	95	200	45	541.41

Single Row Radial Ball Bearings - metric  
 Einreihige Metrische Rillenkugellager  
 Roulements rigides à une rangée de billes - métrique  
 Rodamientos de bolas de una hilera  
 Cuscinetti radiali rigidi a sfera, ad una corona  
 Enradiga radiallykullager - metriskä

NSK	RHP	d	D	B	€
6319M	-	95	200	45	1109.76
6319Z	-	95	200	45	755.26
6319ZZ	-	95	200	45	704.66
6319DDU	-	95	200	45	746.01
6320	-	100	215	47	651.87
6320M	-	100	215	47	1232.80
6320Z	-	100	215	47	910.18
6320ZZ	-	100	215	47	849.23
6320DDU	-	100	215	47	897.60
6321	-	105	225	49	867.52
6321M	-	105	225	49	1378.71
6321ZZ	-	105	225	49	1040.41
6322	-	110	240	50	959.64
6322M	-	110	240	50	1526.15
6322ZZ	-	110	240	50	1220.83
6324	-	120	260	55	1164.56
6324M	-	120	260	55	1906.90
6324DDU	-	120	260	55	1604.73
6326	-	130	280	58	1746.09
6326M	-	130	280	58	2234.98
6328	-	140	300	62	1865.79
6328M	-	140	300	62	2612.11
6330	-	150	320	65	2260.18
6330M	-	150	320	65	3164.25
6332	-	160	340	68	3155.29
6334M	-	170	360	72	5379.20
6336M	-	180	380	75	7210.76
6338M	-	190	400	78	7237.48
6403	-	17	62	17	50.37
6403ZZ	-	17	62	17	60.40
6404	-	20	72	19	65.19
6404AZZ	-	20	72	19	78.12
6405	-	25	80	21	75.02
6405ZZ	-	25	80	21	91.71
6406	-	30	90	23	94.31
6406ZZ	-	30	90	23	115.34
6407	-	35	100	25	113.92
6407AZZ	-	35	100	25	139.17
6408	-	40	110	27	140.94
6408ZZ	-	40	110	27	173.99

Single Row Radial Ball Bearings - metric  
 Einreihige Metrische Rillenkugellager  
 Roulements rigides à une rangée de billes - métrique  
 Rodamientos de bolas de una hilera  
 Cuscinetti radiali rigidi a sfera, ad una corona  
 Enradiga radialkullager - metriska

NSK	RHP	d	D	B	€
6409	-	45	120	29	172.14
6409NR	-	45	120	29	207.91
6409AZZ	-	45	120	29	206.72
6410	-	50	130	31	202.17
6410ZZ	-	50	130	31	242.62
6411	-	55	140	33	241.27
6411ZZ	-	55	140	33	289.42
6412	-	60	150	35	290.13
6413	-	65	160	37	364.94
6413NR	-	65	160	37	462.14
6414	-	70	180	42	518.40
6415	-	75	190	45	767.43
6416	-	80	200	48	871.37
6417	-	85	210	52	1105.59
6418	-	90	225	54	1398.03
6800	-	10	19	5	18.22
6800ZZ	-	10	19	5	23.45
6800DD	-	10	19	5	23.45
6800VV	-	10	19	5	23.45
6801	-	12	21	5	20.01
6801ZZ	-	12	21	5	22.91
6801DD	-	12	21	5	22.91
6801VV	-	12	21	5	22.91
6802	-	15	24	5	20.40
6802ZZ	-	15	24	5	23.65
6802DD	-	15	24	5	23.65
6802VV	-	15	24	5	23.65
6803	-	17	26	5	22.49
6803ZZ	-	17	26	5	27.43
6803DD	-	17	26	5	26.91
6803VV	-	17	26	5	26.91
6804	-	20	32	7	24.32
6804ZZ	-	20	32	7	30.67
6804DD	-	20	32	7	30.67
6804VV	-	20	32	7	30.67
6805	-	25	37	7	28.16
6805ZZ	-	25	37	7	34.96
6805DD	-	25	37	7	34.96
6805VV	-	25	37	7	34.96
6806	-	30	42	7	43.44

Single Row Radial Ball Bearings - metric  
 Einreihige Metrische Rillenkugellager  
 Roulements rigides à une rangée de billes - métrique  
 Rodamientos de bolas de una hilera  
 Cuscinetti radiali rigidi a sfera, ad una corona  
 Enradiga radialkullager - metriskä

NSK	RHP	d	D	B	€
6806ZZ	-	30	42	7	51.30
6806DD	-	30	42	7	50.32
6806VV	-	30	42	7	51.30
6807	-	35	47	7	51.28
6807ZZ	-	35	47	7	57.86
6807VV	-	35	47	7	58.96
6808	-	40	52	7	53.70
6808ZZ	-	40	52	7	63.21
6808DD	-	40	52	7	63.21
6808VV	-	40	52	7	64.41
6809	-	45	58	7	64.06
6809ZZ	-	45	58	7	77.97
6809VV	-	45	58	7	76.10
6810	-	50	65	7	74.26
6810ZZ	-	50	65	7	88.69
6810VV	-	50	65	7	88.69
6811	-	55	72	9	87.32
6811ZZ	-	55	72	9	105.86
6811VV	-	55	72	9	107.88
6812	-	60	78	10	102.33
6812ZZ	-	60	78	10	123.89
6812DD	-	60	78	10	118.66
6812VV	-	60	78	10	123.89
6813	-	65	85	10	117.64
6813ZZ	-	65	85	10	140.68
6813DD	-	65	85	10	134.74
6813VV	-	65	85	10	140.68
6814	-	70	90	10	126.99
6814ZZ	-	70	90	10	150.48
6814DD	-	70	90	10	144.13
6814VV	-	70	90	10	150.48
6815	-	75	95	10	144.92
6815ZZ	-	75	95	10	171.90
6815VV	-	75	95	10	171.90
6816	-	80	100	10	155.44
6816ZZ	-	80	100	10	190.09
6816VV	-	80	100	10	190.09
6817	-	85	110	13	193.71
6817VV	-	85	110	13	250.06
6818	-	90	115	13	214.18

Single Row Radial Ball Bearings - metric  
 Einreihige Metrische Rillenkugellager  
 Roulements rigides à une rangée de billes - métrique  
 Rodamientos de bolas de una hilera  
 Cuscinetti radiali rigidi a sfera, ad una corona  
 Enradiga radialkullager - metriská

NSK	RHP	d	D	B	€
6818ZZ	-	90	115	13	268.68
6818VV	-	90	115	13	287.97
6819	-	95	120	13	235.07
6819DD	-	95	120	13	287.00
6819VV	-	95	120	13	287.00
6820	-	100	125	13	242.84
6820ZZ	-	100	125	13	304.82
6820DD	-	100	125	13	297.56
6820VV	-	100	125	13	326.69
6821	-	105	130	13	267.32
6821VV	-	105	130	13	347.69
6822	-	110	140	16	290.86
6822VV	-	110	140	16	378.26
6824	-	120	150	16	340.97
6824DD	-	120	150	16	412.80
6824VV	-	120	150	16	422.87
6826	-	130	165	18	409.22
6826DD	-	130	165	18	495.09
6826VV	-	130	165	18	543.53
6828	-	140	175	18	484.62
6828ZZ	-	140	175	18	604.30
6828DDU	-	140	175	18	589.91
6828VV	-	140	175	18	604.30
6830	-	150	190	20	565.68
6830M	-	150	190	20	849.82
6832	-	160	200	20	689.33
6832M	-	160	200	20	943.36
6834	-	170	215	22	766.55
6834M	-	170	215	22	1067.53
6836	-	180	225	22	920.85
6836M	-	180	225	22	1219.65
6838	-	190	240	24	968.16
6838M	-	190	240	24	1257.86
6840M	-	200	250	24	1392.30
6844M	-	220	270	24	1648.66
6848M	-	240	300	28	1988.14
6852M	-	260	320	28	2211.97
6856M	-	280	350	33	2503.68
6860M	-	300	380	38	3536.10
6864M	-	320	400	38	4163.11

Single Row Radial Ball Bearings - metric  
 Einreihige Metrische Rillenkugellager  
 Roulements rigides à une rangée de billes - métrique  
 Rodamientos de bolas de una hilera  
 Cuscinetti radiali rigidi a sfera, ad una corona  
 Enradiga radiallykullager - metriskä

NSK	RHP	d	D	B	€
6872M	-	360	440	38	6993.37
6876M	-	380	480	46	8284.77
6884M	-	420	520	46	10669.90
6888M	-	440	540	46	12204.14
6900	-	10	22	6	20.20
6900ZZ	-	10	22	6	22.53
6900DD	-	10	22	6	22.53
6900VV	-	10	22	6	22.53
6901	-	12	24	6	20.32
6901ZZ	-	12	24	6	22.49
6901DD	-	12	24	6	22.49
6901VV	-	12	24	6	22.49
6902	-	15	28	7	22.69
6902ZZ	-	15	28	7	24.90
6902DD	-	15	28	7	24.90
6902VV	-	15	28	7	24.90
6903	-	17	30	7	23.60
6903ZZ	-	17	30	7	25.48
6903DDU	-	17	30	7	25.48
6903VV	-	17	30	7	25.48
6904	-	20	37	9	27.77
6904ZZ	-	20	37	9	30.41
6904DDU	-	20	37	9	30.41
6904VV	-	20	37	9	30.41
6905	-	25	42	9	33.19
6905ZZ	-	25	42	9	39.67
6905DDU	-	25	42	9	39.67
6905VV	-	25	42	9	39.67
6906	-	30	47	9	49.08
6906ZZ	-	30	47	9	51.80
6906DDU	-	30	47	9	50.82
6906VV	-	30	47	9	51.80
6907	-	35	55	10	59.68
6907ZZ	-	35	55	10	64.34
6907DDU	-	35	55	10	64.34
6907VV	-	35	55	10	64.34
6908	-	40	62	12	65.44
6908ZZ	-	40	62	12	74.91
6908DDU	-	40	62	12	74.91
6908VV	-	40	62	12	74.91

Single Row Radial Ball Bearings - metric  
 Einreihige Metrische Rillenkugellager  
 Roulements rigides à une rangée de billes - métrique  
 Rodamientos de bolas de una hilera  
 Cuscinetti radiali rigidi a sfera, ad una corona  
 Enradiga radialkullager - metriska

NSK	RHP	d	D	B	€
6909	-	45	68	12	76.05
6909ZZ	-	45	68	12	89.10
6909DDU	-	45	68	12	87.44
6909VV	-	45	68	12	89.10
6910	-	50	72	12	80.09
6910ZZ	-	50	72	12	103.09
6910DDU	-	50	72	12	103.09
6910VV	-	50	72	12	105.07
6911	-	55	80	13	89.87
6911ZZ	-	55	80	13	108.42
6911VV	-	55	80	13	108.42
6912	-	60	85	13	105.21
6912ZZ	-	60	85	13	141.02
6912DDU	-	60	85	13	141.02
6912VV	-	60	85	13	141.02
6913	-	65	90	13	113.30
6913ZZ	-	65	90	13	141.71
6913DDU	-	65	90	13	144.56
6913VV	-	65	90	13	141.71
6914	-	70	100	16	132.39
6914ZZ	-	70	100	16	165.53
6914VV	-	70	100	16	165.53
6915	-	75	105	16	163.85
6915ZZ	-	75	105	16	189.13
6915VV	-	75	105	16	189.13
6916	-	80	110	16	177.78
6916ZZ	-	80	110	16	191.85
6916DDU	-	80	110	16	191.85
6916VV	-	80	110	16	191.85
6917	-	85	120	18	228.25
6917ZZ	-	85	120	18	264.38
6918	-	90	125	18	240.30
6918ZZ	-	90	125	18	300.50
6918VV	-	90	125	18	300.50
6919	-	95	130	18	269.08
6919ZZ	-	95	130	18	336.62
6920	-	100	140	20	297.71
6920ZZ	-	100	140	20	372.44
6921	-	105	145	20	323.89
6921ZZ	-	105	145	20	405.09



Single Row Radial Ball Bearings - metric  
 Einreihige Metrische Rillenkugellager  
 Roulements rigides à une rangée de billes - métrique  
 Rodamientos de bolas de una hilera  
 Cuscinetti radiali rigidi a sfera, ad una corona  
 Enradiga radiallykullager - metriská

NSK	RHP	d	D	B	€
6922	-	110	150	20	379.73
6922ZZ	-	110	150	20	439.74
6924	-	120	165	22	600.53
6924ZZ	-	120	165	22	720.16
6926	-	130	180	24	850.15
6926ZZ	-	130	180	24	1020.18
6928	-	140	190	24	1101.10
6930	-	150	210	28	1348.18
6930DDU	-	150	210	28	1653.54
6932	-	160	220	28	1598.04
6934	-	170	230	28	1849.58
6936M	-	180	250	33	1959.61
6938M	-	190	260	33	2060.06
6940M	-	200	280	38	2228.69
6944M	-	220	300	38	2537.11
6948M	-	240	320	38	2753.17
6952M	-	260	360	46	3728.38
6956M	-	280	380	46	4336.02
6960M	-	300	420	56	5484.45
6972M	-	360	480	56	9906.03
BO15	-	15	40	10	50.59
BO17	-	17	44	11	51.35
E4	-	4	16	5	24.75
E5	-	5	16	5	23.75
E6	-	6	21	7	23.75
E8	-	8	24	7	26.70
E9	-	9	28	8	26.54
E10	-	10	28	8	27.52
E11	-	11	32	7	27.37
E12	-	12	32	7	27.52
EN12	-	12	32	7	27.52
E13	-	13	30	7	27.52
EN13	-	13	30	7	27.52
E14	-	14	35	8	32.37
E15	-	15	35	8	32.61
E16	-	16	38	10	33.43
E17	-	17	44	11	26.88
E18	-	18	40	9	33.43
E19	-	19	40	9	33.43
E20	-	20	47	12	34.37

Single Row Radial Ball Bearings - metric  
 Einreihige Metrische Rillenkugellager  
 Roulements rigides à une rangée de billes - métrique  
 Rodamientos de bolas de una hilera  
 Cuscinetti radiali rigidi a sfera, ad una corona  
 Enradiga radialkullager - metriská

NSK	RHP	d	D	B	€
BL205	-	25	52	15	87.63
BL206	-	30	62	16	90.20
BL206ZNR	-	30	62	16	123.61
BL206ZZ	-	30	62	16	91.98
BL207	-	35	72	17	91.72
BL207ZZ	-	35	72	17	100.07
BL208	-	40	80	18	93.18
BL208NR	-	40	80	18	115.36
BL208Z	-	40	80	18	95.05
BL208ZNR	-	40	80	18	117.63
BL208ZZ	-	40	80	18	105.26
BL209	-	45	85	19	121.77
BL209NR	-	45	85	19	147.62
BL209ZNR	-	45	85	19	131.01
BL210	-	50	90	20	129.68
BL210ZZ	-	50	90	20	141.47
BL210NR	-	50	90	20	146.67
BL210ZNR	-	50	90	20	158.24
BL211	-	55	100	21	147.96
BL211ZNR	-	55	100	21	161.55
BL211ZZ	-	55	100	21	170.19
BL211NR	-	55	100	21	156.62
BL212NR	-	60	110	22	195.51
BL212Z	-	60	110	22	187.11
BL212ZNR	-	60	110	22	210.27
BL212ZZ	-	60	110	22	209.20
BL213	-	65	120	23	217.45
BL213NR	-	65	120	23	237.29
BL213ZNR	-	65	120	23	258.23
BL214Z	-	70	125	24	275.22
BL215	-	75	130	25	282.97
BL216	-	80	140	26	360.99
BL216ZNR	-	80	140	26	435.40
BL216Z	-	80	140	26	397.09
BL216ZZ	-	80	140	26	373.08
BL218Z	-	90	160	30	428.06
BL305	-	25	62	17	110.08
BL307	-	35	80	21	113.48
BL307NR	-	35	80	21	119.53
BL307Z	-	35	80	21	107.57

Single Row Radial Ball Bearings - metric  
 Einreihige Metrische Rillenkugellager  
 Roulements rigides à une rangée de billes - métrique  
 Rodamientos de bolas de una hilera  
 Cuscinetti radiali rigidi a sfera, ad una corona  
 Enradiga radialkullager - metriskä

NSK	RHP	d	D	B	€
BL307ZNR	-	35	80	21	131.49
BL307ZZ	-	35	80	21	136.17
BL308	-	40	90	23	121.70
BL308NR	-	40	90	23	141.03
BL308Z	-	40	90	23	124.08
BL308ZNR	-	40	90	23	142.16
BL309	-	45	100	25	152.31
BL309NR	-	45	100	25	167.70
BL309ZNR	-	45	100	25	174.48
BL310	-	50	110	27	182.36
BL310NR	-	50	110	27	200.53
BL310ZNR	-	50	110	27	205.12
BL310ZZ	-	50	110	27	187.08
BL311NR	-	55	120	29	255.11
BL311ZNR	-	55	120	29	277.78
BL312	-	60	130	31	296.58
BL312NR	-	60	130	31	319.87
BL312ZNR	-	60	130	31	349.89
BL313	-	65	140	33	346.61
BL313ZNR	-	65	140	33	461.96
BL314	-	70	150	35	429.69
BL314NR	-	70	150	35	478.38
BL314ZNR	-	70	150	35	572.87



**Single Row Radial Ball Bearings - inch**

**Einreihige Zöllige Rillenkugellager**

**Roulements rigides à une rangée de billes - pouce**

**Rodamientos de bolas de una hilera serie pulgadas**

**Cuscinetti radiali rigidi a sfere, ad una corona  
- dimensioni in pollici**

**Enradiga radialkullager - tum**

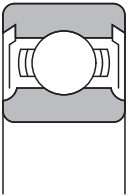
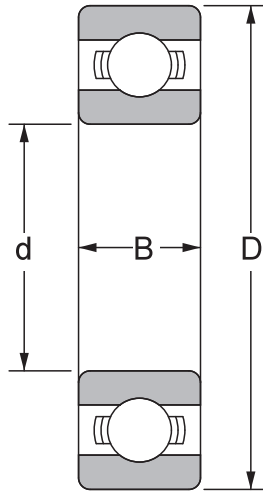

**ZZI-2Z**

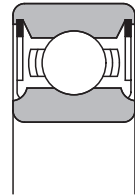

**DDU/-2RS**

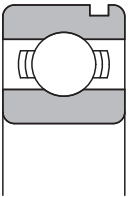

**N**

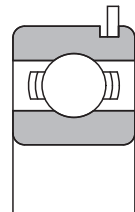

**NR**

Single Row Radial Ball Bearings - inch  
 Einreihige Zöllige Rillenkugellager  
 Roulements rigides à une rangée de billes - pouce  
 Rodamientos de bolas de una hilera serie pulgadas  
 Cuscinetti radiali rigidi a sfera, ad una corona - dimensioni in pollici  
 Enradiga radialkullager - tum

NSK	RHP	d	D	B	€
-	KLNJ1/8Y	1/8	3/8	5/32	*
-	KLNJ3/16Y	3/16	1/2	5/32	*
-	KLNJ1/4Y	1/4	3/4	7/32	*
-	KLNJ1/4-2ZY	1/4	3/4	9/32	*
-	KLNJ1/4-2RSY	1/4	3/4	9/32	*
-	KLNJ3/8-2ZY	3/8	7/8	9/32	*
-	KLNJ3/8-2RSY	3/8	7/8	9/32	*
-	KLNJ1/2Y	1/2	1.1/8	1/4	*
-	KLNJ1/2-2ZY	1/2	1.1/8	5/16	*
-	KLNJ1/2-2RSY	1/2	1.1/8	5/16	*
-	KLNJ5/8Y	5/8	1.3/8	9/32	*
-	KLNJ5/8-2ZY	5/8	1.3/8	11/32	*
-	KLNJ5/8-2RSY	5/8	1.3/8	11/32	*
-	KLNJ3/4J	3/4	1.5/8	5/16	*
-	KLNJ3/4-2ZJ	3/4	1.5/8	7/16	*
-	KLNJ7/8J	7/8	1.7/8	3/8	*
-	KLNJ7/8-2ZJ	7/8	1.7/8	1/2	*
-	KLNJ1J	1	2	3/8	*
-	KLNJ1-2ZJ	1	2	1/2	*
-	KLNJ1-2RSJ	1	2	1/2	*
-	KLNJ1.1/8J	1.1/8	2.1/8	3/8	*
-	KLNJ1.1/4J	1.1/4	2.1/4	3/8	*
-	KLNJ1.1/4-2ZJ	1.1/4	2.1/4	1/2	*
-	KLNJ1.3/8J	1.3/8	2.1/2	7/16	*
-	KLNJ1.1/2J	1.1/2	2.5/8	7/16	*
R2ZZ	-	1/8	3/8	5/32	*
-	R3A-2Z	3/16	1/2	0.196	*
-	R4TNH	1/4	5/8	0.196	*
-	R4-2Z	1/4	5/8	0.196	*
-	R4-2RS	1/4	5/8	0.196	*
-	R4A-2Z	1/4	3/4	9/32	*
R6	-	3/8	7/8	7/32	*
R6ZZ	-	3/8	7/8	9/32	*
R8	-	1/2	1.1/8	1/4	*
R10	-	5/8	1.3/8	9/32	*
R12	-	3/4	1.5/8	5/16	*
R12DDU	-	3/4	1.5/8	7/16	*
R14	-	7/8	1.7/8	3/8	*
R16	-	1	2	3/8	*
R18	-	1.1/8	2.1/8	3/8	*

Single Row Radial Ball Bearings - inch  
 Einreihige Zöllige Rillenkugellager  
 Roulements rigides à une rangée de billes - pouce  
 Rodamientos de bolas de una hilera serie pulgadas  
 Cuscinetti radiali rigidi a sfera, ad una corona - dimensioni in pollici  
 Enradiga radialkullager - tum

NSK	RHP	d	D	B	€
R18ZZ	-	1.1/8	2.1/8	1/2	*
R20	-	1.1/4	2.1/4	3/8	*
-	XLJ1.3/4J	1.3/4	3	9/16	*
-	XLJ2J	2	3.5/16	5/8	*
-	XLJ2.1/4J	2.1/4	3.9/16	5/8	*
-	XLJ2.1/2J	2.1/2	3.7/8	11/16	*
-	XLJ2.3/4M	2.3/4	4.1/8	11/16	*
-	XLJ3J	3	4.1/2	3/4	*
-	XLJ3.1/4M	3.1/4	4.3/4	3/4	*
-	XLJ3.1/2J	3.1/2	5	3/4	*
-	XLJ4M	4	5.5/8	7/8	*
-	XLJ4.1/4J	4.1/4	6	7/8	*
-	XLJ4.1/2J	4.1/2	6.1/4	7/8	*
-	XLJ4.3/4J	4.3/4	6.1/2	7/8	*
-	XLJ5J	5	7	1	*
-	XLJ5M	5	7	1	*
-	XLJ5.1/2M	5.1/2	7.1/2	1	*
-	XLJ6M	6	8	1	*
-	XLJ6.1/2M	6.1/2	8.3/4	1.1/8	*
-	XLJ7M	7	9.1/2	1.1/4	*
RLS4	LJ1/2Y	1/2	1.5/16	3/8	*
RLS4ZZ	LJ1/2-2ZY	1/2	1.5/16	3/8	*
-	LJ1/2-2RSY	1/2	1.5/16	3/8	*
RLS5	LJ5/8J	5/8	1.9/16	7/16	*
RLS5ZZ	LJ5/8-2ZJ	5/8	1.9/16	7/16	*
-	LJ5/8-2RSJ	5/8	1.9/16	7/16	*
RLS6	LJ3/4J	3/4	1.7/8	9/16	*
-	LJ3/4-2ZJ	3/4	1.7/8	9/16	*
-	LJ3/4-2RSJ	3/4	1.7/8	9/16	*
RLS7	LJ7/8J	7/8	2	9/16	*
RLS7ZZ	LJ7/8-2ZJ	7/8	2	9/16	*
-	LJ7/8-2RSJ	7/8	2	9/16	*
RLS8	LJ1J	1	2.1/4	5/8	*
-	LJ1-2ZJ	1	2.1/4	5/8	*
-	LJ1-2RSJ	1	2.1/4	5/8	*
RLS9	LJ1.1/8J	1.1/8	2.1/2	5/8	*
-	LJ1.1/8-2ZJ	1.1/8	2.1/2	5/8	*
-	LJ1.1/8-2RSJ	1.1/8	2.1/2	5/8	*
RLS10	LJ1.1/4J	1.1/4	2.3/4	11/16	*
-	LJ1.1/4-2ZJ	1.1/4	2.3/4	11/16	*



Single Row Radial Ball Bearings - inch  
 Einreihige Zöllige Rillenkugellager  
 Roulements rigides à une rangée de billes - pouce  
 Rodamientos de bolas de una hilera serie pulgadas  
 Cuscinetti radiali rigidi a sfera, ad una corona - dimensioni in pollici  
 Enradiga radialkullager - tum

NSK	RHP	d	D	B	€
-	LJ1.1/4-2RSJ	1.1/4	2.3/4	11/16	*
RLS11	LJ1.3/8J	1.3/8	3	11/16	*
-	LJ1.3/8-2RSJ	1.3/8	3	11/16	*
RLS12	LJ1.1/2J	1.1/2	3.1/4	3/4	*
-	LJ1.1/2-2ZJ	1.1/2	3.1/4	3/4	*
-	LJ1.1/2-2RSJ	1.1/2	3.1/4	3/4	*
RLS13	LJ1.5/8J	1.5/8	3.1/2	3/4	*
RLS14	LJ1.3/4J	1.3/4	3.3/4	13/16	*
-	LJ1.3/4-2ZJ	1.3/4	3.3/4	13/16	*
RLS15	LJ1.7/8J	1.7/8	4	13/16	*
RLS16	LJ2J	2	4	13/16	*
RLS18	LJ2.1/4J	2.1/4	4.1/2	7/8	*
-	LJ2.1/2J	2.1/2	5	15/16	*
-	LJ2.3/4J	2.3/4	5.1/4	15/16	*
RLS24	LJ3J	3	5.3/4	1.1/16	*
-	LJ3.1/4J	3.1/4	6	1.1/16	*
RLS28	LJ3.1/2J	3.1/2	6.1/2	1.1/8	*
-	LJ3.3/4J	3.3/4	6.3/4	1.1/8	*
-	LJ4J	4	7.1/4	1.1/4	*
-	LJ4.1/4J	4.1/4	7.1/2	1.1/4	*
-	LJ4.1/2J	4.1/2	8	1.5/16	*
-	LJ5J	5	9	1.3/8	*
-	LJ5.1/2J	5.1/2	9.1/2	1.3/8	*
-	LJ6.1/2M	6.1/2	11	1.9/16	*
-	MJ1/2J	1/2	1.5/8	5/8	*
RMS5	MJ5/8J	5/8	1.13/16	5/8	*
-	MJ5/8-2ZJ	5/8	1.13/16	5/8	*
-	MJ5/8-2RSJ	5/8	1.13/16	5/8	*
RMS6	MJ3/4J	3/4	2	11/16	*
-	MJ3/4-2ZJ	3/4	2	11/16	*
-	MJ3/4-2RSJ	3/4	2	11/16	*
RMS7	MJ7/8J	7/8	2.1/4	11/16	*
-	MJ7/8-2RSJ	7/8	2.1/4	11/16	*
RMS8	MJ1J	1	2.1/2	3/4	*
-	MJ1-2ZJ	1	2.1/2	7/8	*
-	MJ1-2RSJ	1	2.1/2	7/8	*
RMS9	MJ1.1/8J	1.1/8	2.13/16	13/16	*
RMS10	MJ1.1/4J	1.1/4	3.1/8	7/8	*
-	MJ1.1/4NRJ	1.1/4	3.1/8	7/8	*
-	MJ1.1/4-2RSJ	1.1/4	3.1/8	7/8	*

Single Row Radial Ball Bearings - inch  
 Einreihige Zöllige Rillenkugellager  
 Roulements rigides à une rangée de billes - pouce  
 Rodamientos de bolas de una hilera serie pulgadas  
 Cuscinetti radiali rigidi a sfera, ad una corona - dimensioni in pollici  
 Enradiga radialkullager - tum

NSK	RHP	d	D	B	€
RMS11	MJ1.3/8J	1.3/8	3.1/2	7/8	*
RMS12	MJ1.1/2J	1.1/2	3.3/4	15/16	*
RMS13	MJ1.5/8J	1.5/8	4	15/16	*
RMS14	MJ1.3/4J	1.3/4	4.1/4	1.1/16	*
RMS15	MJ1.7/8J	1.7/8	4.1/2	1.1/16	*
RMS16	MJ2J	2	4.1/2	1.1/16	*
RMS18	MJ2.1/4J	2.1/4	5	1.1/4	*
RMS20	MJ2.1/2J	2.1/2	5.1/2	1.1/4	*
RMS22	MJ2.3/4J	2.3/4	6.1/4	1.3/8	*
RMS24	MJ3J	3	7	1.9/16	*
RMS26	MJ3.1/4J	3.1/4	7.1/2	1.9/16	*
-	MJ3.3/8J	3.3/8	7.1/2	1.9/16	*
-	MJ3.1/2J	3.1/2	8.1/8	1.3/4	*
-	MJ3.3/4J	3.3/4	8.1/4	1.3/4	*
-	MJ4J	4	8.1/2	1.3/4	*
-	MJ4.1/4M	4.1/4	8.3/4	1.3/4	*
-	MJ4.1/2J	4.1/2	9.3/8	2	*
-	MJ4.3/4J	4.3/4	10	2	*
-	MJ5J	5	10	2	*

**Double Row Radial Ball Bearings**

**Zweireihige Rillenkugellager**

**Roulements rigides à deux rangée de billes - métrique**

**Rodamientos de bolas de doble hilera**

**Cuscinetti radiali rigidi a sfere, ad due corone**

**Tvåradiga radialkullager**

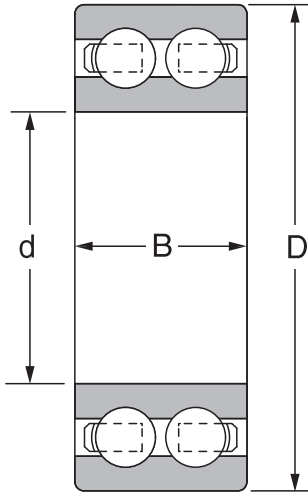

**4200B**

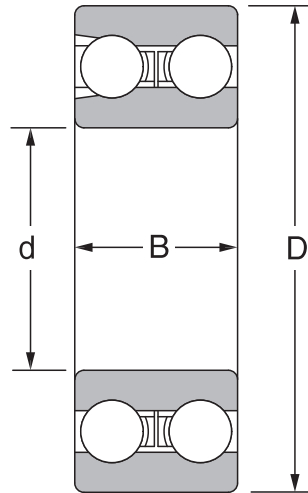

**4200M  
4300M**

Double Row Radial Ball Bearings  
 Zweireihige Rillenkugellager  
 Roulements rigides à deux rangée de billes - métrique  
 Rodamientos de bolas de doble hilera  
 Cuscinetti radiali rigidi a sfera, ad due corone  
 Tvåradiga radialkullager

NSK	RHP	d	D	B	€
4200BTN	-	10	30	14	45.87
4200J	-	10	30	14	114.67
4201BTN	-	12	32	14	45.97
4201J	-	12	32	14	114.94
4202BTN	-	15	35	14	47.70
4202J	-	15	35	14	95.40
4203BTN	-	17	40	16	51.93
4203J	-	17	40	16	103.86
4204BTN	-	20	47	18	54.10
4204J	-	20	47	18	108.20
4205BTN	-	25	52	18	57.58
4205J	-	25	52	18	115.16
4206BTN	-	30	62	20	66.61
4206J	-	30	62	20	133.22
4207BTN	-	35	72	23	82.12
4207J	-	35	72	23	164.24
4208BTN	-	40	80	23	94.86
4208J	-	40	80	23	189.72
4209BTN	-	45	85	23	109.25
4210BTN	-	50	90	23	121.00
4211BTN	-	55	100	25	177.24
4211J	-	55	100	25	255.46
4212BTN	-	60	110	28	207.99
4212J	-	60	110	28	266.14
4213BTN	-	65	120	31	275.44
4213J	-	65	120	31	344.28
4214BTN	-	70	125	31	298.00
4214J	-	70	125	31	789.20
4215BTN	-	75	130	31	349.55
4215J	-	75	130	31	699.13
4216BTN	-	80	140	33	432.50
4217BTN	-	85	150	36	745.04
4218BTN	-	90	160	40	772.42
4302BTN	-	15	42	17	67.83
4303BTN	-	17	47	19	71.85
4303J	-	17	47	19	88.10
4304BTN	-	20	52	21	72.99
4304J	-	20	52	21	145.98
4305BTN	-	25	62	24	81.48
4305J	-	25	62	24	162.96

Double Row Radial Ball Bearings  
 Zweireihige Rillenkugellager  
 Roulements rigides à deux rangée de billes - métrique  
 Rodamientos de bolas de doble hilera  
 Cuscinetti radiali rigidi a sfera, ad due corone  
 Tvåradiga radialkullager

NSK	RHP	d	D	B	€
4306BTN	-	30	72	27	97.92
4306J	-	30	72	27	195.85
4307BTN	-	35	80	31	116.71
4307J	-	35	80	31	233.41
4308BTN	-	40	90	33	147.97
4308J	-	40	90	33	258.94
4309BTN	-	45	100	36	299.05
4310BTN	-	50	110	40	304.23
4311BTN	-	55	120	43	388.53
4312BTN	-	60	130	46	477.54
4313BTN	-	65	140	48	544.70
4314BTN	-	70	150	51	633.81

**Double Row Self-Aligning Ball Bearings - metric**

**Zweireihige Metrische Pendelkugellager**

**Roulements à deux rangées de billes auto-aligneurs  
- métrique**

**Rodamientos de bolas autoalineantes de doble hilera**

**Cuscinetti radiali orientabili a sfera**

**Tvåradiga sfäriska kullager - metriska**

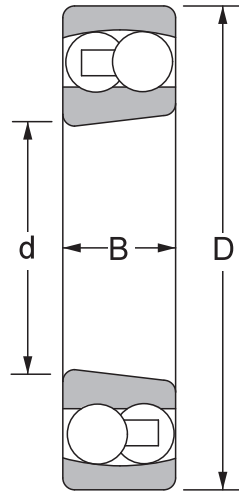
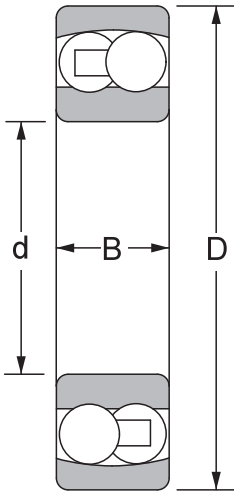

K

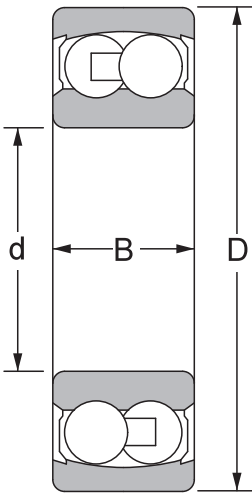

2200 - 2RS  
2300 - 2RS

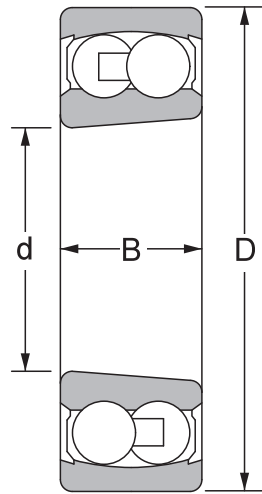

K



Double Row Self-Aligning Ball Bearings - metric  
 Zweireihige Metrische Pendelkugellager  
 Roulements à deux rangées de billes auto-aligneurs - métrique  
 Rodamientos de bolas autoalineantes de doble hilera  
 Cuscinetti radiali orientabili a sfera  
 Tváradiga sfáriska kullager - metriská

NSK	RHP	d	D	B	€
126	-	6	19	6	30.95
127WA	-	7	22	7	30.87
108WA	-	8	22	7	33.22
129WA	-	9	26	8	34.94
1200J	-	10	30	9	43.88
1201TN	-	12	32	10	39.85
1201J	-	12	32	10	46.85
1202TN	-	15	35	11	40.42
1202J	-	15	35	11	44.47
1203TN	-	17	40	12	38.97
1203J	-	17	40	12	45.46
1204TN	-	20	47	14	38.68
1204J	-	20	47	14	50.53
1204KTN	-	20	47	14	41.79
1205TN	-	25	52	15	41.27
1205J	-	25	52	15	53.92
1205KTN	-	25	52	15	42.44
1205KJ	-	25	52	15	54.96
1206TN	-	30	62	16	44.64
1206J	-	30	62	16	61.72
1206KTN	-	30	62	16	48.12
1206KJ	-	30	62	16	62.90
1207TN	-	35	72	17	54.76
1207J	-	35	72	17	75.68
1207KTN	-	35	72	17	55.28
1207KJ	-	35	72	17	75.68
1208TN	-	40	80	18	64.07
1208J	-	40	80	18	84.69
1208KTN	-	40	80	18	64.07
1208KJ	-	40	80	18	86.32
1209TN	-	45	85	19	69.76
1209J	-	45	85	19	92.25
1209KTN	-	45	85	19	70.43
1209KJ	-	45	85	19	92.25
1210TN	-	50	90	20	80.01
1210J	-	50	90	20	107.81
1210KTN	-	50	90	20	80.01
1210KJ	-	50	90	20	107.81
1211TN	-	55	100	21	99.78
1211J	-	55	100	21	131.91

Double Row Self-Aligning Ball Bearings - metric  
 Zweireihige Metrische Pendelkugellager  
 Roulements à deux rangées de billes auto-aligneurs - métrique  
 Rodamientos de bolas autoalineantes de doble hilera  
 Cuscinetti radiali orientabili a sfera  
 Tvåradiga sfäriska kullager - metriska

NSK	RHP	d	D	B	€
1211KTN	-	55	100	21	97.89
1211KJ	-	55	100	21	131.91
1212TN	-	60	110	22	118.44
1212J	-	60	110	22	149.51
1212KTN	-	60	110	22	118.44
1212KJ	-	60	110	22	149.51
1213J	-	65	120	23	180.27
1213KTN	-	65	120	23	142.84
1213KJ	-	65	120	23	180.27
1214J	-	70	125	24	160.69
1214KJ	-	70	125	24	160.69
1215J	-	75	130	25	182.13
1215KJ	-	75	130	25	180.40
1216J	-	80	140	26	213.27
1216KJ	-	80	140	26	213.27
1217J	-	85	150	28	266.65
1217KJ	-	85	150	28	266.65
1218J	-	90	160	30	320.80
1218KJ	-	90	160	30	320.80
1219J	-	95	170	32	381.89
1219KJ	-	95	170	32	381.89
1220J	-	100	180	34	453.53
1220KJ	-	100	180	34	453.53
1221J	-	105	190	36	557.98
1222J	-	110	200	38	626.93
1222K	-	110	200	38	626.93
1300J	-	10	35	11	42.23
1301J	-	12	37	12	55.88
1302TN	-	15	42	13	48.05
1302J	-	15	42	13	55.23
1303TN	-	17	47	14	47.52
1303J	-	17	47	14	60.02
1304TN	-	20	52	15	49.52
1304J	-	20	52	15	63.09
1304KJ	-	20	52	15	64.30
1305TN	-	25	62	17	57.69
1305J	-	25	62	17	72.77
1305KTN	-	25	62	17	59.36
1305KJ	-	25	62	17	74.16
1306TN	-	30	72	19	71.27

Double Row Self-Aligning Ball Bearings - metric  
 Zweireihige Metrische Pendelkugellager  
 Roulements à deux rangées de billes auto-aligneurs - métrique  
 Rodamientos de bolas autoalineantes de doble hilera  
 Cuscinetti radiali orientabili a sfera  
 Tváradiga sfáriska kullager - metriská

NSK	RHP	d	D	B	€
1306J	-	30	72	19	91.72
1306KTN	-	30	72	19	73.35
1306KJ	-	30	72	19	91.72
1307TN	-	35	80	21	82.70
1307J	-	35	80	21	104.40
1307KTN	-	35	80	21	85.09
1307KJ	-	35	80	21	104.40
1308TN	-	40	90	23	100.86
1308J	-	40	90	23	127.28
1308KTN	-	40	90	23	103.78
1308KJ	-	40	90	23	127.28
1309TN	-	45	100	25	125.03
1309J	-	45	100	25	159.30
1309KTN	-	45	100	25	127.41
1309KJ	-	45	100	25	159.30
1310TN	-	50	110	27	154.87
1310J	-	50	110	27	195.49
1310KTN	-	50	110	27	156.35
1310KJ	-	50	110	27	195.49
1311TN	-	55	120	29	184.69
1311J	-	55	120	29	233.10
1311KTN	-	55	120	29	184.69
1311KJ	-	55	120	29	273.52
1312J	-	60	130	31	229.43
1312KJ	-	60	130	31	231.63
1313J	-	65	140	33	316.77
1313KJ	-	65	140	33	316.77
1314J	-	70	150	35	360.78
1314KJ	-	70	150	35	360.78
1315J	-	75	160	37	423.94
1315KJ	-	75	160	37	423.94
1316J	-	80	170	39	486.69
1316KJ	-	80	170	39	486.69
1317J	-	85	180	41	636.31
1317KJ	-	85	180	41	636.31
1318J	-	90	190	43	673.53
1318KJ	-	90	190	43	673.53
1319J	-	95	200	45	976.28
1319KJ	-	95	200	45	976.28
1320J	-	100	215	47	1205.99

Double Row Self-Aligning Ball Bearings - metric  
 Zweireihige Metrische Pendelkugellager  
 Roulements à deux rangées de billes auto-aligneurs - métrique  
 Rodamientos de bolas autoalineantes de doble hilera  
 Cuscinetti radiali orientabili a sfera  
 Tvåradiga sfäriska kullager - metriska

NSK	RHP	d	D	B	€
1320KJ	-	100	215	47	1205.99
1322J	-	110	240	50	2468.09
2200J	-	10	30	14	40.69
2201ETN	-	12	32	14	44.34
2201J	-	12	32	14	50.19
2201M	-	12	32	14	80.62
2201-2RSTN	-	12	32	14	48.96
2202ETN	-	15	35	14	44.54
2202J	-	15	35	14	50.65
2202-2RSTN	-	15	35	14	49.84
2203ETN	-	17	40	16	44.57
2203J	-	17	40	16	49.03
2203-2RSTN	-	17	40	16	53.15
2204ETN	-	20	47	18	47.14
2204J	-	20	47	18	52.43
2204KJ	-	20	47	18	48.04
2204-2RSTN	-	20	47	18	57.29
2205ETN	-	25	52	18	49.88
2205J	-	25	52	18	55.94
2205EKTN	-	25	52	18	50.84
2205KJ	-	25	52	18	55.92
2205-2RSTN	-	25	52	18	60.56
2205K-2RSTN	-	25	52	18	61.70
2206ETN	-	30	62	20	57.75
2206J	-	30	62	20	64.76
2206EKTN	-	30	62	20	58.86
2206KJ	-	30	62	20	64.76
2206-2RSTN	-	30	62	20	70.12
2206K-2RSTN	-	30	62	20	70.12
2207ETN	-	35	72	23	69.23
2207J	-	35	72	23	77.61
2207EKTN	-	35	72	23	69.23
2207KJ	-	35	72	23	77.61
2207-2RSTN	-	35	72	23	84.11
2207K-2RSTN	-	35	72	23	85.71
2208ETN	-	40	80	23	79.01
2208J	-	40	80	23	88.57
2208EKTN	-	40	80	23	79.01
2208KJ	-	40	80	23	88.57
2208-2RSTN	-	40	80	23	99.69

Double Row Self-Aligning Ball Bearings - metric  
 Zweireihige Metrische Pendelkugellager  
 Roulements à deux rangées de billes auto-aligneurs - métrique  
 Rodamientos de bolas autoalineantes de doble hilera  
 Cuscinetti radiali orientabili a sfera  
 Tvåradiga sfäriska kullager - metriska

NSK	RHP	d	D	B	€
2208K-2RSTN	-	40	80	23	101.61
2209ETN	-	45	85	23	92.47
2209J	-	45	85	23	103.68
2209EKTN	-	45	85	23	92.47
2209KJ	-	45	85	23	103.68
2209-2RSTN	-	45	85	23	112.91
2209K-2RSTN	-	45	85	23	112.91
2210ETN	-	50	90	23	103.70
2210J	-	50	90	23	105.67
2210EKTN	-	50	90	23	103.70
2210KJ	-	50	90	23	105.67
2210-2RSTN	-	50	90	23	126.83
2210K-2RSTN	-	50	90	23	129.26
2211ETN	-	55	100	25	126.87
2211J	-	55	100	25	126.87
2211EKTN	-	55	100	25	124.50
2211KJ	-	55	100	25	126.87
2211-2RSTN	-	55	100	25	154.91
2211K-2RSTN	-	55	100	25	160.01
2212ETN	-	60	110	28	154.15
2212J	-	60	110	28	154.15
2212EKTN	-	60	110	28	154.15
2212KJ	-	60	110	28	154.15
2212-2RSTN	-	60	110	28	188.45
2213ETN	-	65	120	31	186.83
2213J	-	65	120	31	186.83
2213EKTN	-	65	120	31	186.83
2213KJ	-	65	120	31	186.83
2214J	-	70	125	31	232.73
2214KJ	-	70	125	31	232.73
2215J	-	75	130	31	283.04
2215KJ	-	75	130	31	283.04
2216J	-	80	140	33	341.97
2216KJ	-	80	140	33	341.97
2217J	-	85	150	36	419.00
2217KJ	-	85	150	36	419.00
2218J	-	90	160	40	504.94
2218KJ	-	90	160	40	504.94
2219J	-	95	170	43	963.62
2219KJ	-	95	170	43	963.62

Double Row Self-Aligning Ball Bearings - metric  
 Zweireihige Metrische Pendelkugellager  
 Roulements à deux rangées de billes auto-aligneurs - métrique  
 Rodamientos de bolas autoalineantes de doble hilera  
 Cuscinetti radiali orientabili a sfera  
 Tvåradiga sfäriska kullager - metriska

NSK	RHP	d	D	B	€
2220J	-	100	180	46	981.80
2220KJ	-	100	180	46	981.80
2221J	-	105	190	50	1086.64
2222J	-	110	200	53	1230.56
2222KJ	-	110	200	53	1230.56
2300J	-	10	35	17	66.13
2301J	-	12	37	17	66.13
2301M	-	12	37	17	132.24
2302ETN	-	15	42	17	64.99
2302J	-	15	42	17	66.23
2302-2RSTN	-	15	42	17	73.80
2303J	-	17	47	19	77.32
2303-2RSTN	-	17	47	19	78.36
2304J	-	20	52	21	66.23
2304M	-	20	52	21	132.43
2304KJ	-	20	52	21	66.23
2304-2RSTN	-	20	52	21	78.85
2305TN	-	25	62	24	79.63
2305J	-	25	62	24	89.25
2305M	-	25	62	24	159.32
2305KJ	-	25	62	24	89.25
2305-2RSTN	-	25	62	24	96.74
2306TN	-	30	72	27	99.67
2306J	-	30	72	27	99.67
2306M	-	30	72	27	249.20
2306KJ	-	30	72	27	99.67
2306-2RSTN	-	30	72	27	122.27
2307TN	-	35	80	31	115.81
2307J	-	35	80	31	118.03
2307KTN	-	35	80	31	115.81
2307KJ	-	35	80	31	118.03
2307-2RSTN	-	35	80	31	144.69
2308TN	-	40	90	33	137.69
2308J	-	40	90	33	140.34
2308M	-	40	90	33	344.26
2308KTN	-	40	90	33	137.69
2308KJ	-	40	90	33	140.34
2308-2RSTN	-	40	90	33	179.03
2309TN	-	45	100	36	171.50
2309J	-	45	100	36	171.50

Double Row Self-Aligning Ball Bearings - metric  
 Zweireihige Metrische Pendelkugellager  
 Roulements à deux rangées de billes auto-aligneurs - métrique  
 Rodamientos de bolas autoalineantes de doble hilera  
 Cuscinetti radiali orientabili a sfera  
 Tváradiga sfáriska kullager - metriská

NSK	RHP	d	D	B	€
2309M	-	45	100	36	393.65
2309KTN	-	45	100	36	171.50
2309KJ	-	45	100	36	171.50
2309-2RSTN	-	45	100	36	227.23
2310TN	-	50	110	40	221.25
2310J	-	50	110	40	221.25
2310KTN	-	50	110	40	221.25
2310KJ	-	50	110	40	221.25
2310-2RSTN	-	50	110	40	276.38
2311TN	-	55	120	43	273.52
2311J	-	55	120	43	273.52
2311M	-	55	120	43	546.68
2311KTN	-	55	120	43	273.52
2311KJ	-	55	120	43	273.52
2312J	-	60	130	46	337.95
2312KJ	-	60	130	46	337.95
2313J	-	65	140	48	407.28
2313KJ	-	65	140	48	407.28
2314J	-	70	150	51	505.68
2315J	-	75	160	55	636.66
2315KJ	-	75	160	55	636.66
2316J	-	80	170	58	774.11
2316KJ	-	80	170	58	774.11
2317J	-	85	180	60	1236.56
2317KJ	-	85	180	60	1236.56
2318J	-	90	190	64	1558.92
2318KJ	-	90	190	64	1558.92
11204TN	-	20	47	40	76.00
11205TN	-	25	52	44	82.78
11206TN	-	30	62	48	96.91
11207TN	-	35	72	52	121.60
11208TN	-	40	80	56	141.76
11209TN	-	45	85	58	161.32
11210TN	-	50	90	58	175.48





**Single Row Angular Contact Ball Bearings - metric**

**Einreihige Metrische Schrägkugellager**

**Roulements à une rangée de billes à contact oblique  
- métrique**

**Rodamientos de contacto angular de una hilera**

**Cuscinetti a sfere a contatto obliquo, ad una corona**

**Enradiga vinkelkontaktkullager - metriskä**

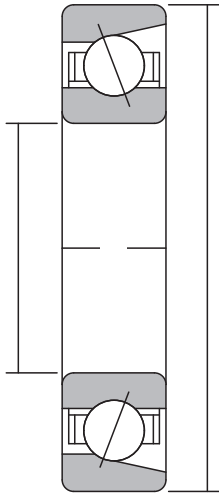

20°

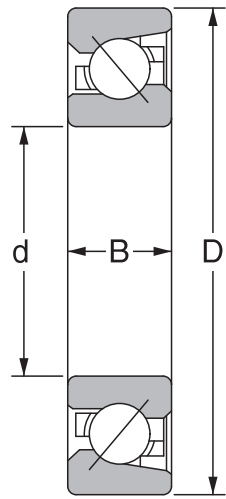

40°

Single Row Angular Contact Ball Bearings - metric  
 Einreihige Metrische Schrägkugellager  
 Roulements à une rangée de billes à contact oblique - métrique  
 Rodamientos de contacto angular de una hilera  
 Cuscinetti a sfera a contatto obliquo, ad una corona  
 Enradiga vinkelkontaktkullager - metriskä

NSK	RHP	d	D	B	€
7002BM	-	15	32	9	114.09
7004AM	-	20	42	12	121.03
7006AM	-	30	55	13	175.42
7006BM	-	30	55	13	175.42
7007AM	-	35	62	14	177.14
7007BM	-	35	62	14	177.14
7008AM	-	40	68	15	180.85
7008BM	-	40	68	15	180.85
7009AM	-	45	75	16	188.20
7010AM	-	50	80	16	200.74
7010BM	-	50	80	16	200.74
7011AW	-	55	90	18	80.02
7011BM	-	55	90	18	298.39
7012BM	-	60	95	18	335.64
7014AM	-	70	110	20	394.64
7014BM	-	70	110	20	394.64
7200BW	-	10	30	9	32.13
7200BWG	-	10	30	9	57.26
7201BEAT85	-	12	32	10	31.13
7201BW	-	12	32	10	34.58
7201BEAT85SUN	-	12	32	10	55.98
7201BWG	-	12	32	10	61.58
7202BEAT85	-	15	35	11	30.48
7202BW	-	15	35	11	33.85
7202BEAT85SUN	-	15	35	11	56.20
7202BWG	-	15	35	11	61.83
7203BEAT85	-	17	40	12	32.51
7203BW	-	17	40	12	36.12
7203BEAT85SUN	-	17	40	12	61.44
7203BWG	-	17	40	12	67.59
7204BEAT85	-	20	47	14	34.58
7204BW	-	20	47	14	38.96
7204BEAT85SUN	-	20	47	14	65.76
7204BWG	-	20	47	14	75.51
7205BEAT85	-	25	52	15	37.60
7205BW	-	25	52	15	43.56
7205BEAT85SUN	-	25	52	15	71.95
7205BWG	-	25	52	15	79.15
7206BEAT85	-	30	62	16	44.98
7206BW	-	30	62	16	50.68

Single Row Angular Contact Ball Bearings - metric  
 Einreihige Metrische Schrägkugellager  
 Roulements à une rangée de billes à contact oblique - métrique  
 Rodamientos de contacto angular de una hilera  
 Cuscinetti a sfera a contatto obliquo, ad una corona  
 Enradiga vinkelkontaktkullager - metriskä

NSK	RHP	d	D	B	€
7206BEAT85SUN	-	30	62	16	80.19
7206BWG	-	30	62	16	88.20
7207BEAT85	-	35	72	17	54.78
7207BW	-	35	72	17	60.25
7207BEAT85SUN	-	35	72	17	89.19
7207BWG	-	35	72	17	98.12
7208BEAT85	-	40	80	18	63.68
7208BW	-	40	80	18	71.75
7208BEAT85SUN	-	40	80	18	102.75
7208BWG	-	40	80	18	126.18
7209BEAT85	-	45	85	19	73.49
7209BW	-	45	85	19	82.00
7209BEAT85SUN	-	45	85	19	113.83
7209BWG	-	45	85	19	139.79
7210BEAT85	-	50	90	20	82.39
7210BW	-	50	90	20	88.82
7210BEAT85SUN	-	50	90	20	124.20
7210BWG	-	50	90	20	152.52
7211BEAT85	-	55	100	21	103.33
7211BW	-	55	100	21	107.87
7211BEAT85SUN	-	55	100	21	149.43
7211BWG	-	55	100	21	183.51
7212BEAT85	-	60	110	22	125.88
7212BW	-	60	110	22	141.82
7212BEAT85SUN	-	60	110	22	172.99
7212BWG	-	60	110	22	212.43
7213BEAT85	-	65	120	23	152.33
7213BW	-	65	120	23	161.15
7213BEAT85SUN	-	65	120	23	202.68
7213BWG	-	65	120	23	248.91
7214BEAT85	-	70	125	24	176.86
7214BW	-	70	125	24	199.27
7214BEAT85SUN	-	70	125	24	228.05
7214BWG	-	70	125	24	298.82
7215BEAT85	-	75	130	25	199.31
7215BW	-	75	130	25	224.56
7215BEAT85SUN	-	75	130	25	253.30
7215BWG	-	75	130	25	339.33
7216BEAT85	-	80	140	26	242.13
7216BW	-	80	140	26	272.79

Single Row Angular Contact Ball Bearings - metric  
 Einreihige Metrische Schrägkugellager  
 Roulements à une rangée de billes à contact oblique - métrique  
 Rodamientos de contacto angular de una hilera  
 Cuscinetti a sfera a contatto obliquo, ad una corona  
 Enradiga vinkelkontaktkullager - metriskä

NSK	RHP	d	D	B	€
7216BEAT85SUN	-	80	140	26	290.14
7216BWG	-	80	140	26	364.83
7217BW	-	85	150	28	293.06
7217BWG	-	85	150	28	418.84
7218BW	-	90	160	30	354.75
7218BWG	-	90	160	30	470.32
7219BW	-	95	170	32	422.76
7219BWG	-	95	170	32	525.95
7220BW	-	100	180	34	482.93
7220BWG	-	100	180	34	550.11
7221BW	-	105	190	36	567.95
7221BMG	-	105	190	36	808.05
7222BW	-	110	200	38	647.42
7222BWG	-	110	200	38	718.18
7224BM	-	120	215	40	1098.44
7224BMG	-	120	215	40	1127.85
7226BM	-	130	230	40	1375.66
7226BMG	-	130	230	40	1412.56
7228BMG	-	140	250	42	1797.58
7230BMG	-	150	270	45	2246.82
7234BMG	-	170	310	52	3186.63
7300BW	-	10	35	11	35.62
7301BEAT85	-	12	37	12	62.85
7301BW	-	12	37	12	67.82
7301BEAT85SUN	-	12	37	12	66.60
7302BEAT85	-	15	42	13	39.72
7302BW	-	15	42	13	43.71
7302BWG	-	15	42	13	83.27
7303BEAT85	-	17	47	14	39.61
7303BW	-	17	47	14	44.00
7303BEAT85SUN	-	17	47	14	75.73
7303BWG	-	17	47	14	81.70
7304BEAT85	-	20	52	15	41.64
7304BW	-	20	52	15	46.90
7304BEAT85SUN	-	20	52	15	80.95
7304BWG	-	20	52	15	87.36
7305BEAT85	-	25	62	17	49.40
7305BW	-	25	62	17	55.66
7305BEAT85SUN	-	25	62	17	86.91
7305BWG	-	25	62	17	95.60

Single Row Angular Contact Ball Bearings - metric  
 Einreihige Metrische Schrägkugellager  
 Roulements à une rangée de billes à contact oblique - métrique  
 Rodamientos de contacto angular de una hilera  
 Cuscinetti a sfera a contatto obliquo, ad una corona  
 Enradiga vinkelkontaktkullager - metriskä

NSK	RHP	d	D	B	€
7306BEAT85	-	30	72	19	59.55
7306BW	-	30	72	19	67.12
7306BEAT85SUN	-	30	72	19	98.82
7306BWG	-	30	72	19	108.72
7307BEAT85	-	35	80	21	72.50
7307BW	-	35	80	21	81.68
7307BEAT85SUN	-	35	80	21	109.85
7307BWG	-	35	80	21	120.85
7308BEAT85	-	40	90	23	93.08
7308BW	-	40	90	23	104.89
7308BEAT85SUN	-	40	90	23	133.32
7308BWG	-	40	90	23	146.66
7309BEAT85	-	45	100	25	114.14
7309BW	-	45	100	25	128.61
7309BEAT85SUN	-	45	100	25	154.49
7309BWG	-	45	100	25	169.94
7310BEAT85	-	50	110	27	142.81
7310BW	-	50	110	27	160.91
7310BEAT85SUN	-	50	110	27	190.11
7310BWG	-	50	110	27	209.11
7311BEAT85	-	55	120	29	181.28
7311BW	-	55	120	29	204.24
7311BEAT85SUN	-	55	120	29	225.73
7311BWG	-	55	120	29	248.30
7312BEAT85	-	60	130	31	220.53
7312BW	-	60	130	31	248.47
7312BEAT85SUN	-	60	130	31	281.60
7312BWG	-	60	130	31	309.75
7313BEAT85	-	65	140	33	293.02
7313BW	-	65	140	33	300.13
7313BEAT85SUN	-	65	140	33	338.89
7313BWG	-	65	140	33	355.03
7314BEAT85	-	70	150	35	353.78
7314BW	-	70	150	35	398.60
7314BEAT85SUN	-	70	150	35	401.65
7314BWG	-	70	150	35	462.87
7315BEAT85	-	75	160	37	445.00
7315BW	-	75	160	37	501.37
7315BEAT85SUN	-	75	160	37	524.17
7315BWG	-	75	160	37	576.59

Single Row Angular Contact Ball Bearings - metric  
 Einreihige Metrische Schrägkugellager  
 Roulements à une rangée de billes à contact oblique - métrique  
 Rodamientos de contacto angular de una hilera  
 Cuscinetti a sfera a contatto obliquo, ad una corona  
 Enradiga vinkelkontaktkullager - metriskä

NSK	RHP	d	D	B	€
7316BEAT85	-	80	170	39	522.78
7316BW	-	80	170	39	530.35
7316BEAT85SUN	-	80	170	39	599.01
7316BWG	-	80	170	39	662.46
7317BW	-	85	180	41	636.51
7317BWG	-	85	180	41	710.30
7318BW	-	90	190	43	738.89
7318BWG	-	90	190	43	824.78
7319BW	-	95	200	45	869.88
7319BWG	-	95	200	45	939.69
7320BW	-	100	215	47	1042.01
7320BWG	-	100	215	47	1123.55
7320BM	-	100	215	47	1311.50
7320BMG	-	100	215	47	1325.13
7321BM	-	105	225	49	1467.64
7321BMG	-	105	225	49	1590.86
7322BW	-	110	240	50	1465.85
7322BWG	-	110	240	50	1562.59
7322BM	-	110	240	50	1848.33
7322BMG	-	110	240	50	1877.71
7324BM	-	120	260	55	2204.87
7324BMG	-	120	260	55	2382.22
7326BM	-	130	280	58	2622.45
7326BMG	-	130	280	58	2870.53
7328BM	-	140	300	62	3406.38
7328BMG	-	140	300	62	3747.69
7330BM	-	150	320	65	3961.13
7330BMG	-	150	320	65	4238.61
7332BMG	-	160	340	68	5429.70
7334BMG	-	170	360	72	6507.38
7336BM	-	180	380	75	8065.77
7336BMG	-	180	380	75	8868.67
7405BMG	-	25	80	21	284.49
7406BMG	-	30	90	23	320.93
7407BMG	-	35	100	25	340.44
7408BW	-	40	110	27	377.64
7408BMG	-	40	110	27	382.98
7409BMG	-	45	120	29	595.72
7410BMG	-	50	130	31	634.04
7411BMG	-	55	140	33	711.46

Single Row Angular Contact Ball Bearings - metric  
Einreihige Metrische Schrägkugellager  
Roulements à une rangée de billes à contact oblique - métrique  
Rodamientos de contacto angular de una hilera  
Cuscinetti a sfere a contatto obliquo, ad una corona  
Enradiga vinkelkontaktkullager - metriskä

NSK	RHP	d	D	B	€
7412BMG	-	60	150	35	1030.63
7413BMG	-	65	160	37	1240.72
7414BMG	-	70	180	42	1449.52
7415BMG	-	75	190	45	1739.84
7418BMG	-	90	225	54	2088.62



**Single Row Angular Contact Ball Bearings - inch**

**Einreihige Zöllige Schrägkugellager**

**Roulements à une rangée de billes à contact oblique -  
pouce**

**Rodamientos de contacto angular de una hilera serie  
pulgadas**

**Cuscinetti a sfere a contatto obliquo, ad una corona -  
dimensioni in pollici**

**Enradiga vinkelkontaktkullager - tum**

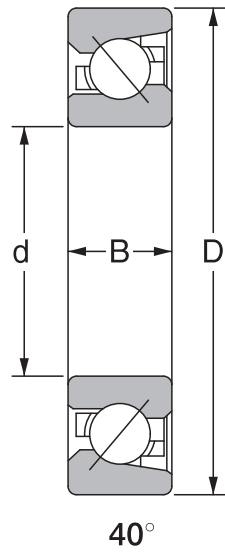
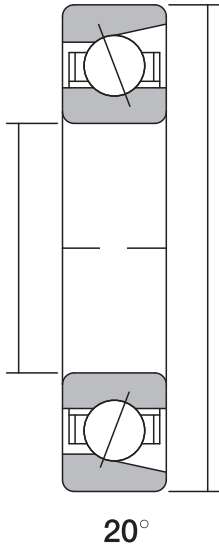

Single Row Angular Contact Ball Bearings - inch

Einreihige Zöllige Schrägkugellager

Roulements à une rangée de billes à contact oblique - pouce

Rodamientos de contacto angular de una hilera serie pulgadas

Cuscinetti a sfere a contatto obliquo, ad una corona - dimensioni in pollici

Enradiga vinkelkontaktkullager - tum

NSK	RHP	d	D	B	€
-	LJT5/8M	5/8	1.9/16	7/16	*
-	LJT3/4M	3/4	1.7/8	9/16	*
-	LJT7/8M	7/8	2	9/16	*
-	LJT1M	1	2.1/4	5/8	*
-	LJT1.1/8M	1.1/8	2.1/2	5/8	*
-	LJT1.1/4M	1.1/4	2.3/4	11/16	*
-	LJT1.3/8M	1.3/8	3	11/16	*
-	LJT1.1/2M	1.1/2	3.1/4	3/4	*
-	LJT1.5/8M	1.5/8	3.1/2	3/4	*
-	LJT1.3/4M	1.3/4	3.3/4	13/16	*
-	LJT1.7/8M	1.7/8	4	13/16	*
-	LJT2M	2	4	13/16	*
-	LJT2.1/4M	2.1/4	4.1/2	7/8	*
-	LJT2.1/2M	2.1/2	5	15/16	*
-	LJT2.3/4M	2.3/4	5.1/4	15/16	*
-	LJT3M	3	5.3/4	1.1/16	*
-	LJT3.1/4M	3.1/4	6	1.1/16	*
-	LJT3.1/2M	3.1/2	6.1/2	1.1/8	*
-	LJT3.3/4M	3.3/4	6.3/4	1.1/8	*
-	LJT4M	4	7.1/4	1.1/4	*
-	LJT4.1/2M	4.1/2	8	1.5/16	*
-	LJT5M	5	9	1.3/8	*
-	LJT5.1/2M	5.1/2	9.1/2	1.3/8	*
-	LJT6M	6	10.1/2	1.9/16	*
-	LJT6.1/2M	6.1/2	11	1.9/16	*
-	LJT7M	7	12	1.3/4	*
-	MJT1M	1	2.1/2	0.75	*
-	MJT1.1/8M	1.1/8	2.13/16	13/16	*
-	MJT1.1/4M	1.1/4	3.1/8	0.875	*
-	MJT1.3/8M	1.3/8	3.1/2	0.875	*
-	MJT1.1/2M	1.1/2	3.3/4	15/16	*
-	MJT1.5/8M	1.5/8	4	15/16	*
-	MJT1.3/4M	1.3/4	4.1/4	1.1/16	*
-	MJT1.7/8M	1.7/8	4.1/2	1.1/16	*
-	MJT2M	2	4.1/2	1.1/16	*
-	MJT2.1/4M	2.1/4	5	1.1/4	*
-	MJT2.1/2M	2.1/2	5.1/2	1.1/4	*
-	MJT2.3/4M	2.3/4	6.1/4	1.3/8	*
-	MJT3M	3	7	1.9/16	*
-	MJT3.1/4M	3.1/4	7.1/2	1.9/16	*

Single Row Angular Contact Ball Bearings - inch  
 Einreihige Zöllige Schrägkugellager  
 Roulements à une rangée de billes à contact oblique - pouce  
 Rodamientos de contacto angular de una hilera serie pulgadas  
 Cuscinetti a sfere a contatto obliquo, ad una corona - dimensioni in pollici  
 Enradiga vinkelkontaktkullager - tum

NSK	RHP	d	D	B	€
-	MJT3.1/2M	3.1/2	8.1/8	1.3/4	*
-	MJT4M	4	8.1/2	1.3/4	*
-	MJT4.1/2M	4.1/2	8	1.5/16	*

**Double Row Angular Contact Ball Bearings**

**Zweireihiges Schrägkugellager**

**Roulements à deux rangées de billes à contact oblique**

**Rodamientos de bolas de contacto angular de doble hilera**

**Cuscinetti a sfere a contatto obliquo, ad due corona**

**Tvåradiga vinkelkontaktkullager**

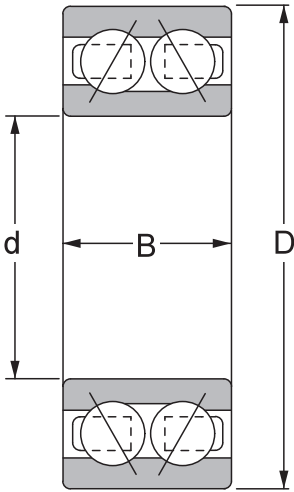

32-B & 33-B  
25°

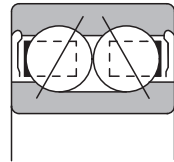

-2ZR

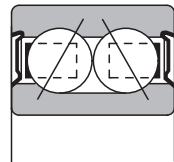

-2RSR

Double Row Angular Contact Ball Bearings  
 Zweireihiges Schrägkugellager  
 Roulements à deux rangées de billes à contact oblique  
 Rodamientos de bolas de contacto angular de doble hilera  
 Cuscinetti a sfera a contatto obliquo, ad due corona  
 Tvåradiga vinkelkontaktkullager

NSK	RHP	d	D	B	€
3200A	-	10	30	14	60.04
3200BTN	-	10	30	14	54.58
3200B-2ZTN	-	10	30	14	60.07
3200B-2RSTN	-	10	30	14	65.54
3201BTN	-	12	32	15.9	55.67
3201J	-	12	32	15.9	62.37
3201B-2ZTN	-	12	32	15.9	61.20
3201B-2RSTN	-	12	32	15.9	66.77
3202BTN	-	15	35	15.9	56.51
3202J	-	15	35	15.9	71.98
3202B-2ZTN	-	15	35	15.9	63.99
3202B-2RSTN	-	15	35	15.9	67.77
3203BTN	-	17	40	17.5	56.51
3203J	-	17	40	17.5	72.00
3203B-2ZTN	-	17	40	17.5	62.21
3203B-2RSTN	-	17	40	17.5	65.91
3204BTN	-	20	47	20.6	60.13
3204J	-	20	47	20.6	82.23
3204B-2ZTN	-	20	47	20.6	66.08
3204B-2RSTN	-	20	47	20.6	69.21
3205BTN	-	25	52	20.6	63.47
3205J	-	25	52	20.6	85.39
3205BNRTN	-	25	52	20.6	69.82
3205B-2ZTN	-	25	52	20.6	69.92
3205B-2RSTN	-	25	52	20.6	72.91
3205B-2RSNRTN	-	25	52	20.6	81.74
3206BTN	-	30	62	23.8	75.64
3206J	-	30	62	23.8	101.88
3206BNRTN	-	30	62	23.8	83.24
3206B-2ZTN	-	30	62	23.8	83.24
3206B-2ZNRTN	-	30	62	23.8	93.31
3206B-2RSTN	-	30	62	23.8	86.87
3206B-2RSNRTN	-	30	62	23.8	95.56
3207BTN	-	35	72	27	89.74
3207J	-	35	72	27	106.67
3207BNRTN	-	35	72	27	98.76
3207B-2ZTN	-	35	72	27	103.02
3207B-2RSTN	-	35	72	27	107.71
3208BTN	-	40	80	30.2	114.61
3208J	-	40	80	30.2	124.86

Double Row Angular Contact Ball Bearings  
 Zweireihiges Schrägkugellager  
 Roulements à deux rangées de billes à contact oblique  
 Rodamientos de bolas de contacto angular de doble hilera  
 Cuscinetti a sfere a contatto obliquo, ad due corona  
 Tvåradiga vinkelkontaktkullager

NSK	RHP	d	D	B	€
3208B-2ZTN	-	40	80	30.2	128.57
3208B-2RSTN	-	40	80	30.2	131.64
3209BTN	-	45	85	30.2	131.64
3209J	-	45	85	30.2	149.92
3209B-2ZTN	-	45	85	30.2	144.90
3209B-2RSTN	-	45	85	30.2	153.66
3210BTN	-	50	90	30.2	142.23
3210J	-	50	90	30.2	167.48
3210B-2ZTN	-	50	90	30.2	169.63
3210B-2RSTN	-	50	90	30.2	171.26
3211BTN	-	55	100	33.3	173.98
3211J	-	55	100	33.3	201.09
3211B-2ZTN	-	55	100	33.3	201.68
3211B-2RSTN	-	55	100	33.3	215.95
3212BTN	-	60	110	36.5	232.08
3212WA	-	60	110	36.5	246.61
3212B-2ZTN	-	60	110	36.5	255.17
3212B-2RSTN	-	60	110	36.5	278.38
3213BTN	-	65	120	38.1	248.70
3213J	-	65	120	38.1	281.67
3213B-2ZTN	-	65	120	38.1	278.65
3213B-2RSTN	-	65	120	38.1	303.85
3214BTN	-	70	125	39.7	285.99
3214J	-	70	125	39.7	323.86
3214B-2ZTN	-	70	125	39.7	320.48
3214B-2RSTN	-	70	125	39.7	349.51
3216M	-	140	80	44.4	503.20
3218M	-	160	90	52.4	610.28
3302BTN	-	15	42	19	72.06
3302	-	15	42	19	91.77
3302B-2ZTN	-	15	42	19	81.99
3302B-2RSTN	-	15	42	19	86.43
3303BTN	-	17	47	22.2	76.79
3303J	-	17	47	22.2	95.98
3303B-2ZTN	-	17	47	22.2	85.73
3303B-2RSTN	-	17	47	22.2	90.41
3304BTN	-	20	52	22.2	81.38
3304J	-	20	52	22.2	105.16
3304B-2ZTN	-	20	52	22.2	92.40
3304B-2RSTN	-	20	52	22.2	94.82



Double Row Angular Contact Ball Bearings  
 Zweireihiges Schrägkugellager  
 Roulements à deux rangées de billes à contact oblique  
 Rodamientos de bolas de contacto angular de doble hilera  
 Cuscinetti a sfera a contatto obliquo, ad due corona  
 Tvåradiga vinkelkontaktkullager

NSK	RHP	d	D	B	€
3305BTN	-	25	62	25.4	97.17
3305J	-	25	62	25.4	110.55
3305BNRTN	-	25	62	25.4	108.42
3305B-2ZTN	-	25	62	25.4	110.59
3305B-2RSTN	-	25	62	25.4	111.58
3306BTN	-	30	72	30.2	116.37
3306J	-	30	72	30.2	132.37
3306BNRTN	-	30	72	30.2	127.92
3306B-2ZTN	-	30	72	30.2	130.44
3306B-2RSTN	-	30	72	30.2	135.56
3307BTN	-	35	80	34.9	136.00
3307J	-	35	80	34.9	152.59
3307BNRTN	-	35	80	34.9	151.77
3307B-2ZTN	-	35	80	34.9	154.39
3307B-2RSTN	-	35	80	34.9	158.78
3308BTN	-	40	90	36.5	170.82
3308J	-	40	90	36.5	191.58
3308BNRTN	-	40	90	36.5	191.45
3308NRJ	-	40	90	36.5	210.75
3308B-2ZTN	-	40	90	36.5	194.21
3308B-2ZNRTN	-	40	90	36.5	213.49
3308B-2RSTN	-	40	90	36.5	198.78
3309BTN	-	45	100	39.7	213.65
3309J	-	45	100	39.7	234.97
3309BNRTN	-	45	100	39.7	234.97
3309NRJ	-	45	100	39.7	230.72
3309B-2ZTN	-	45	100	39.7	234.97
3309B-2RSTN	-	45	100	39.7	261.21
3310BTN	-	50	110	44.4	263.25
3310J	-	50	110	44.4	304.57
3310BNRTN	-	50	110	44.4	299.73
3310NRJ	-	50	110	44.4	342.86
3310B-2ZTN	-	50	110	44.4	299.73
3310B-2RSTN	-	50	110	44.4	327.13
3311BTN	-	55	120	49.2	309.90
3311J	-	55	120	49.2	344.26
3311BNRTN	-	55	120	49.2	340.86
3311B-2ZTN	-	55	120	49.2	340.86
3311B-2RSTN	-	55	120	49.2	371.70
3312BTN	-	60	130	54	378.89

Double Row Angular Contact Ball Bearings  
 Zweireihiges Schrägkugellager  
 Roulements à deux rangées de billes à contact oblique  
 Rodamientos de bolas de contacto angular de doble hilera  
 Cuscinetti a sfere a contatto obliquo, ad due corona  
 Tvåradiga vinkelkontaktkullager

NSK	RHP	d	D	B	€
3312J	-	60	130	54	401.16
3312NRJ	-	60	130	54	463.19
3312B-2ZTN	-	60	130	54	416.80
3312B-2RSTN	-	60	130	54	455.04
3313BTN	-	65	140	58.7	462.85
3313WA	-	65	140	58.7	514.83
3313BNRTN	-	65	140	58.7	509.43
3313B-2ZTN	-	65	140	58.7	509.43
3313B-2RSTN	-	65	140	58.7	555.62
3314J	-	70	150	63.5	607.73
3316M	-	80	170	68.3	1327.95
LB3200B-2ZRSTN	-	10	32	14	70.35
LB3201B-2ZRSTN	-	12	35	15.9	70.35
LB3202B-2ZRSTN	-	15	40	15.9	72.86
LB3203B-2ZRSTN	-	17	47	17.5	78.44
LB3204B-2ZRSTN	-	20	52	20.6	84.21
LB3205B-2ZRSTN	-	25	62	20.6	98.17
LB3206B-2ZRSTN	-	30	72	23.8	116.01
LB3207B-2ZRSTN	-	35	80	27	129.56
LZ3200B-2ZRSTN	-	10	32	14	70.35
LZ3201B-2ZRSTN	-	12	35	15.9	70.35
LZ3202B-2ZRSTN	-	15	40	15.9	72.86
LZ3203B-2ZRSTN	-	17	47	17.5	78.44
LZ3204B-2ZRSTN	-	20	52	20.6	84.21
LZ3205B-2ZRSTN	-	25	62	20.6	98.02
LZ3206B-2ZRSTN	-	30	72	23.8	116.01
LZ3207B-2ZRSTN	-	35	80	27	132.34

**Thrust Ball Bearings - metric**

**Metrische Axial-Rillenkugellager**

**Butées à billes - métrique**

**Rodamientos axiales de bolas**

**Cuscinetti assiali a sfera**

**Axialkullager - metriska**

The 53200, 53300 and 53400 series are supplied with seat washers ("U") as standard and are inclusive in the price.

Die serien 53200, 53300 und 53400 warden Standardmaß mitt unterlegscheiben ("U") geliefert, welche im preis inbegriffen sind.

Les series 53200, 53300 et 53400 sont fournies équipées de rondelles de positionnement ("U") en serie comprises dans le prix.

Las series 53200, 53300 y 53400 son suministrades con la arandela de asiento de alineación ("U") incluida en el precio.

Le serie 53200, 53300 e 53400 soon fornite con rondelle per sedi ("U") standard ed include nel prezzo.

Seriema 53200, 53300 och 53400 levereras med mellanläggsbrickor for sätet ("U") som standard och dessa ingår i priset.

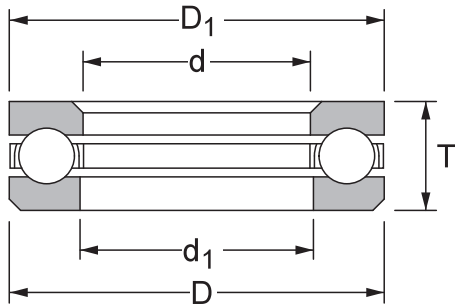

Thrust Ball Bearings - metric  
 Metrische Axial-Rillenkugellager  
 Butées à billes - métrique  
 Rodamientos axiales de bolas  
 Cuscinetti assiali a sfera  
 Axialkullager - metriska

NSK	RHP	d	D	T	€
51100	-	10	24	9	22.59
51101	-	12	26	9	22.67
51102	-	15	28	9	22.39
51103	-	17	30	9	22.67
51104	-	20	35	10	22.74
51105	-	25	42	11	25.14
51106	-	30	47	11	27.05
51107	-	35	53	12	28.84
51108	-	40	60	13	34.85
51109	-	45	65	14	39.66
51110	-	50	70	14	43.16
51111	-	55	78	16	53.48
51112	-	60	85	17	59.50
51113	-	65	90	18	64.38
51114	-	70	95	18	70.29
51115	-	75	100	19	79.81
51116	-	80	105	19	90.41
51117	-	85	110	19	102.22
51118	-	90	120	22	123.53
51120	-	100	135	25	192.26
51122	-	110	145	25	213.45
51124	-	120	155	25	266.64
51126	-	130	170	30	351.52
51128	-	140	180	31	443.39
51130	-	150	190	31	599.46
51132	-	160	200	31	788.67
51134	-	170	215	34	914.27
51136	-	180	225	34	990.77
51138	-	190	240	37	1009.85
51140	-	200	250	37	1193.47
51144	-	220	270	37	1464.39
51148	-	240	300	45	1842.58
51152	-	260	320	45	2261.63
51156M	-	280	350	53	2927.44
51164M	-	320	400	63	5147.23
51200	-	10	26	11	28.10
51201	-	12	28	11	28.19
51202	-	15	32	12	27.46
51203	-	17	35	12	28.87
51204	-	20	40	14	30.20

Thrust Ball Bearings - metric  
 Metrische Axial-Rillenkugellager  
 Butées à billes - métrique  
 Rodamientos axiales de bolas  
 Cuscinetti assiali a sfera  
 Axialkullager - metriska

NSK	RHP	d	D	T	€
51205	-	25	47	15	33.65
51206	-	30	53	16	38.01
51207	-	35	62	18	46.86
51208	-	40	68	19	52.62
51209	-	45	73	20	57.64
51210	-	50	78	22	64.22
51211	-	55	90	25	88.45
51212	-	60	95	26	96.69
51213	-	65	100	27	110.79
51214	-	70	105	27	122.72
51215	-	75	110	27	135.69
51216	-	80	115	28	152.18
51217	-	85	125	31	196.53
51218	-	90	135	35	233.94
51220	-	100	150	38	311.28
51222	-	110	160	38	387.66
51224	-	120	170	39	481.03
51226	-	130	190	45	607.96
51228	-	140	200	46	1064.26
51230	-	150	215	50	1206.89
51232	-	160	225	51	1400.20
51234	-	170	240	55	1597.04
51236	-	180	250	56	1701.79
51238M	-	190	270	62	2074.37
51240M	-	200	280	62	2295.39
51244M	-	220	300	63	2738.39
51248M	-	240	340	78	4559.32
51256M	-	280	380	80	6396.30
51304	-	20	47	18	45.13
51305	-	25	52	18	46.67
51306	-	30	60	21	53.27
51307	-	35	68	24	64.53
51308	-	40	78	26	79.02
51309	-	45	85	28	94.56
51310	-	50	95	31	123.53
51311	-	55	105	35	160.30
51312	-	60	110	35	192.24
51313	-	65	115	36	262.78
51314	-	70	125	40	309.71
51315	-	75	135	44	376.27

Thrust Ball Bearings - metric  
 Metrische Axial-Rillenkugellager  
 Butées à billes - métrique  
 Rodamientos axiales de bolas  
 Cuscinetti assiali a sfera  
 Axialkullager - metriska

NSK	RHP	d	D	T	€
51316	-	80	140	44	414.96
51317	-	85	150	49	497.53
51318	-	90	155	50	557.76
51320	-	100	170	55	679.24
51322	-	110	190	63	1270.96
51324	-	120	210	70	1711.76
51326	-	130	225	75	2200.20
51328	-	140	240	80	2594.98
51330	-	150	250	80	3156.74
51332	-	160	270	87	4223.05
51334	-	170	280	87	4941.68
51336	-	180	300	95	5703.63
51338M	-	190	320	105	6438.69
51405	-	25	60	24	100.60
51406	-	30	70	28	102.03
51407	-	35	80	32	128.48
51408	-	40	90	36	151.48
51409	-	45	100	39	195.25
51410	-	50	110	43	246.74
51411	-	55	120	48	367.50
51412	-	60	130	51	683.89
51413	-	65	140	56	850.97
51414	-	70	150	60	1073.93
51415	-	75	160	65	1321.60
51416	-	80	170	68	1625.67
51417	-	85	180	72	2103.22
51418	-	90	190	77	2580.78
51420M	-	100	210	85	3131.64
51422M	-	110	230	95	3872.87
51424M	-	120	250	102	4988.99
52202	-	10	32	22	72.93
52204	-	15	40	26	81.60
52205	-	20	47	28	85.44
52206	-	25	52	29	86.37
52207	-	30	62	34	111.50
52208	-	30	68	36	128.22
52209	-	35	73	37	145.87
52210	-	40	78	39	152.12
52211	-	45	90	45	201.96
52212	-	50	95	46	228.82

Thrust Ball Bearings - metric  
 Metrische Axial-Rillenkugellager  
 Butées à billes - métrique  
 Rodamientos axiales de bolas  
 Cuscinetti assiali a sfera  
 Axialkullager - metriska

NSK	RHP	d	D	T	€
52213	-	55	100	47	262.99
52214	-	55	105	47	298.61
52215	-	60	110	47	334.28
52216	-	65	115	48	375.54
52217	-	70	125	55	468.53
52218	-	75	135	62	558.25
52220	-	85	150	67	795.51
52222	-	95	160	67	968.40
52224	-	100	170	68	1115.78
52226	-	110	190	80	1561.42
52228	-	120	200	81	2236.68
52230	-	130	215	89	2974.81
52232	-	140	225	90	4007.91
52234	-	150	240	97	4779.09
52305	-	20	52	34	138.64
52306	-	25	60	38	149.20
52307	-	30	68	44	163.26
52308	-	30	78	49	198.64
52309	-	35	85	52	247.12
52310	-	40	95	58	323.70
52311	-	45	105	64	439.24
52312	-	50	110	64	496.48
52313	-	55	115	65	661.47
52314	-	55	125	72	817.12
52315	-	60	135	79	902.33
52316	-	65	140	79	975.25
52317	-	70	150	87	1211.71
52318	-	75	155	88	1445.44
52320	-	85	170	97	1911.98
53200	-	10	28	13	56.77
53201	-	12	30	13	68.22
53202	-	15	35	15	71.77
53203	-	17	38	15	73.69
53204	-	20	42	17	98.18
53205	-	25	50	19	91.01
53206	-	30	55	20	117.10
53207	-	35	65	22	122.71
53208	-	40	72	23	134.39
53209	-	45	78	24	147.66
53210	-	50	82	26	165.91



Thrust Ball Bearings - metric  
 Metrische Axial-Rillenkugellager  
 Butées à billes - métrique  
 Rodamientos axiales de bolas  
 Cuscinetti assiali a sfera  
 Axialkullager - metriska

NSK	RHP	d	D	T	€
53211	-	55	95	30	202.25
53212	-	60	100	31	243.71
53213	-	65	105	32	256.23
53214	-	70	110	32	284.96
53215	-	75	115	32	322.12
53216	-	80	120	33	355.08
53217	-	85	130	37	421.43
53218	-	90	140	42	488.06
53220	-	100	155	45	618.86
53222	-	110	165	45	739.21
53224	-	120	175	46	997.93
53226	-	130	195	53	1259.40
53228	-	140	210	55	1853.81
53306	-	30	62	25	123.54
53307	-	35	72	28	145.73
53308	-	40	82	31	201.06
53309	-	45	90	33	208.88
53310	-	50	100	37	266.23
53311	-	55	110	42	368.23
53312	-	60	115	42	393.67
53313	-	65	120	43	447.52
53314	-	70	130	48	562.98
53315	-	75	140	52	643.23
53316	-	80	145	52	711.76
53317	-	85	155	58	853.57
53318	-	90	160	59	727.63
53320	-	100	175	64	1221.33
53322	-	110	195	72	1857.78
53324	-	120	220	80	3079.57
53326	-	130	235	86	3826.64
53405	-	25	62	29	122.16
53406	-	30	75	33	187.97
53407	-	35	85	37	219.29
53408	-	40	95	42	303.64
53409	-	45	105	46	441.80
53410	-	50	115	50	492.26
53411	-	55	125	55	746.88
53412	-	60	135	58	999.30
53413	-	65	145	65	1253.63
53414	-	70	155	69	1506.96

Thrust Ball Bearings - metric  
 Metrische Axial-Rillenkugellager  
 Butées à billes - métrique  
 Rodamientos axiales de bolas  
 Cuscinetti assiali a sfera  
 Axialkullager - metriska

NSK	RHP	d	D	T	€
53415	-	75	165	75	1799.03
53416	-	80	175	78	2014.23
54204	-	15	42	32	142.16
54205	-	20	50	36	164.53
54206	-	25	55	37	185.59
54207	-	30	65	42	206.62
54208	-	30	72	44	254.72
54209	-	35	78	45	301.76
54210	-	40	82	47	369.24
54211	-	45	95	55	478.78
54212	-	50	100	56	632.41
54305	-	20	55	42	187.83
54306	-	25	62	46	192.12
54307	-	30	72	52	216.09
54308	-	30	82	59	268.07
54309	-	35	90	62	316.62
54310	-	40	100	70	387.79
54311	-	45	110	78	410.90
54312	-	50	115	78	537.21
54313	-	55	120	79	572.85
54314	-	55	130	88	666.56
54315	-	60	140	95	855.16
54316	-	65	145	95	1153.18
54317	-	70	155	105	1322.47
54322	-	95	195	128	2653.44
54405	-	15	62	55	397.39
54406	-	20	75	62	526.39
54407	-	25	85	69	461.12
54408	-	30	95	77	742.47
54409	-	35	105	86	900.19
54410	-	40	115	92	984.71
54412	-	50	135	107	1778.24
54413	-	50	145	119	2428.19
54415	-	60	165	135	3977.95

**Thrust Ball Bearings - inch**

**Zöllige Axial-Rillenkugellager**

**Butées à billes - pouce**

**Rodamientos axiales de bolas serie pulgadas**

**Cuscinetti assiali a sfera - dimensioni in pollici**

**Axialkullager - tum**

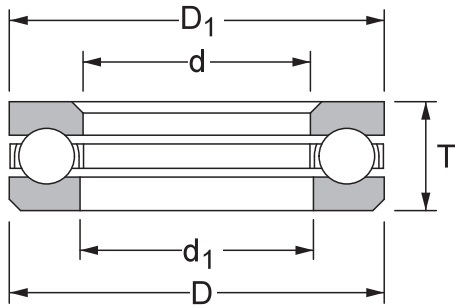

XLT O/LT MT

Thrust Ball Bearings - inch  
 Zöllige Axial-Rillenkugellager  
 Butées à billes - pouce  
 Rodamientos axiales de bolas serie pulgadas  
 Cuscinetti assiali a sfere - dimensioni in pollici  
 Axialkullager - tum

NSK	RHP	d	D	T	€
O-4	-	-	-	-	*
O-5	-	-	-	-	*
O-6	-	-	-	-	*
O-7	-	-	-	-	*
O-8	-	-	-	-	*
O-9	-	-	-	-	*
O-10	-	-	-	-	*
O-11	-	-	-	-	*
O-12	-	-	-	-	*
O-13	-	-	-	-	*
O-14	-	-	-	-	*
O-16	-	-	-	-	*
O-17	-	-	-	-	*
O-18	-	-	-	-	*
O-24	-	-	-	-	*
O-28	-	-	-	-	*



**Cylindrical Roller Bearings - metric**

**Metrische Zylinderrollenlager**

**Roulements à rouleaux cylindriques - métrique**

**Rodamientos de rodillos cilíndricos**

**Cuscinetti a rulli cilindrici**

**Cylindriska kullager - metriska**

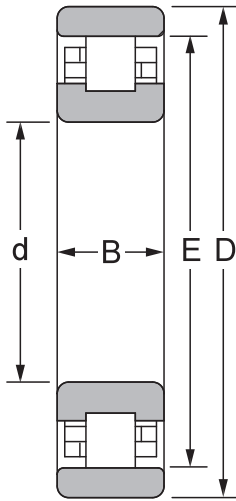

**N**

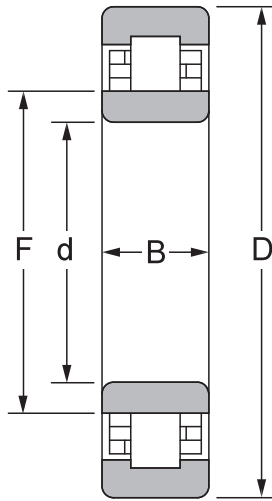

**NU**

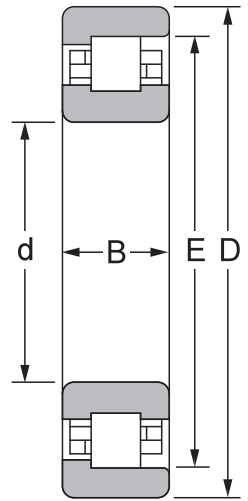

**NF**

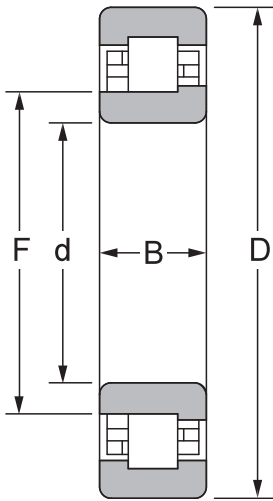

**NJ**

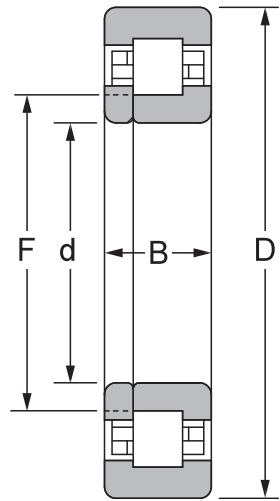

**NUP**



Cylindrical Roller Bearings - metric  
 Metrische Zylinderrollenlager  
 Roulements à rouleaux cylindriques - métrique  
 Rodamientos de rodillos cilíndricos  
 Cuscinetti a rulli cilindrici  
 Cylindriska kullager - metriska

NSK	RHP	d	D	B	€
NU202W	-	15	35	11	57.29
NU203W	-	17	40	12	58.27
NJ203W	-	17	40	12	56.68
N203W	-	17	40	12	79.33
NF203W	-	17	40	12	77.28
NU204ET	-	20	47	14	53.30
NU204W	-	20	47	14	60.37
NJ204ET	-	20	47	14	59.53
NJ204W	-	20	47	14	68.35
NUP204W	-	20	47	14	98.20
N204ET	-	20	47	14	87.70
N204W	-	20	47	14	96.48
NF204W	-	20	47	14	82.03
NU205ET	-	25	52	15	57.07
NU205EW	-	25	52	15	64.59
NU205EM	-	25	52	15	127.29
NJ205ET	-	25	52	15	63.77
NJ205EW	-	25	52	15	73.20
NUP205ET	-	25	52	15	76.21
N205ET	-	25	52	15	87.81
N205W	-	25	52	15	96.61
NF205W	-	25	52	15	87.82
NU206ET	-	30	62	16	66.87
NJ206ET	-	30	62	16	73.49
NUP206ET	-	30	62	16	85.99
NUP206EW	-	30	62	16	97.29
N206ET	-	30	62	16	89.47
N206W	-	30	62	16	98.42
NF206W	-	30	62	16	108.60
NU207ET	-	35	72	17	78.52
NU207EM	-	35	72	17	182.65
NJ207ET	-	35	72	17	85.72
NJ207EW	-	35	72	17	109.19
NUP207ET	-	35	72	17	96.62
N207ET	-	35	72	17	111.22
N207W	-	35	72	17	116.81
NF207W	-	35	72	17	126.86
NU208ET	-	40	80	18	88.43
NU208EW	-	40	80	18	101.93
NJ208ET	-	40	80	18	99.20

Cylindrical Roller Bearings - metric  
 Metrische Zylinderrollenlager  
 Roulements à rouleaux cylindriques - métrique  
 Rodamientos de rodillos cilíndricos  
 Cuscinetti a rulli cilindrici  
 Cylindriska kullager - metriska

NSK	RHP	d	D	B	€
NUP208ET	-	40	80	18	109.29
NUP208EW	-	40	80	18	123.74
N208ET	-	40	80	18	130.72
N208W	-	40	80	18	137.46
N208M	-	40	80	18	238.82
NF208W	-	40	80	18	146.85
NU209ET	-	45	85	19	98.23
NU209EW	-	45	85	19	110.59
NJ209ET	-	45	85	19	109.38
NJ209EW	-	45	85	19	122.08
NUP209ET	-	45	85	19	124.27
NUP209EW	-	45	85	19	140.54
N209ET	-	45	85	19	134.84
N209W	-	45	85	19	158.81
NF209ET	-	45	85	19	134.44
NF209W	-	45	85	19	150.72
NU210ET	-	50	90	20	106.39
NU210EW	-	50	90	20	122.88
NU210EM	-	50	90	20	297.29
NJ210ET	-	50	90	20	116.97
NJ210EW	-	50	90	20	141.98
NUP210ET	-	50	90	20	136.53
N210W	-	50	90	20	170.07
N210ET	-	50	90	20	146.27
N210M	-	50	90	20	309.38
NF210ET	-	50	90	20	146.48
NF210W	-	50	90	20	172.81
NU211EW	-	55	100	21	143.48
NU211EM	-	55	100	21	330.06
NJ211ET	-	55	100	21	137.44
NUP211ET	-	55	100	21	166.99
N211ET	-	55	100	21	197.76
N211W	-	55	100	21	217.63
NF211ET	-	55	100	21	168.12
NF211W	-	55	100	21	188.46
NU212ET	-	60	110	22	150.51
NU212EW	-	60	110	22	170.42
NJ212ET	-	60	110	22	165.93
NJ212EW	-	60	110	22	182.09
NUP212ET	-	60	110	22	197.16

Cylindrical Roller Bearings - metric  
 Metrische Zylinderrollenlager  
 Roulements à rouleaux cylindriques - métrique  
 Rodamientos de rodillos cilíndricos  
 Cuscinetti a rulli cilindrici  
 Cylindriska kullager - metriska

NSK	RHP	d	D	B	€
N212ET	-	60	110	22	228.63
N212W	-	60	110	22	251.41
NF212W	-	60	110	22	222.71
NU213ET	-	65	120	23	178.30
NU213EW	-	65	120	23	202.65
NU213EM	-	65	120	23	421.22
NJ213ET	-	65	120	23	193.06
NJ213EW	-	65	120	23	228.25
NUP213ET	-	65	120	23	234.18
NUP213EW	-	65	120	23	259.88
N213W	-	65	120	23	297.55
NF213W	-	65	120	23	279.16
NU214ET	-	70	125	24	192.42
NU214W	-	70	125	24	212.26
NU214EM	-	70	125	24	431.75
NJ214ET	-	70	125	24	210.72
NJ214W	-	70	125	24	232.08
NUP214ET	-	70	125	24	257.53
N214W	-	70	125	24	333.47
NF214W	-	70	125	24	283.87
NU215ET	-	75	130	25	211.55
NU215W	-	75	130	25	232.73
NJ215ET	-	75	130	25	238.56
NJ215W	-	75	130	25	320.01
NUP215ET	-	75	130	25	289.90
NUP215W	-	75	130	25	321.90
N215W	-	75	130	25	362.24
NF215W	-	75	130	25	391.45
NU216ET	-	80	140	26	243.07
NU216W	-	80	140	26	267.34
NU216EM	-	80	140	26	446.67
NJ216ET	-	80	140	26	270.24
NJ216W	-	80	140	26	318.64
NUP216ET	-	80	140	26	331.23
NUP216W	-	80	140	26	367.74
N216ET	-	80	140	26	424.22
N216W	-	80	140	26	428.16
N216M	-	80	140	26	778.46
NF216W	-	80	140	26	389.73
NU217ET	-	85	150	28	283.30

Cylindrical Roller Bearings - metric  
 Metrische Zylinderrollenlager  
 Roulements à rouleaux cylindriques - métrique  
 Rodamientos de rodillos cilíndricos  
 Cuscinetti a rulli cilindrici  
 Cylindriska kullager - metriska

NSK	RHP	d	D	B	€
NU217W	-	85	150	28	312.07
NJ217ET	-	85	150	28	312.07
NJ217W	-	85	150	28	346.36
NUP217ET	-	85	150	28	385.99
NUP217EM	-	85	150	28	623.52
N217ET	-	85	150	28	530.26
N217W	-	85	150	28	583.28
NF217W	-	85	150	28	419.64
NU218ET	-	90	160	30	337.01
NU218W	-	90	160	30	372.36
NU218EM	-	90	160	30	681.51
NJ218ET	-	90	160	30	365.62
NJ218W	-	90	160	30	463.86
NUP218ET	-	90	160	30	423.33
NUP218W	-	90	160	30	465.65
N218W	-	90	160	30	670.85
NF218W	-	90	160	30	480.62
NU219ET	-	95	170	32	394.25
NU219W	-	95	170	32	434.16
NU219EM	-	95	170	32	732.55
NJ219ET	-	95	170	32	450.32
NJ219W	-	95	170	32	494.95
NUP219ET	-	95	170	32	630.29
NUP219W	-	95	170	32	693.33
N219W	-	95	170	32	675.24
NU220ET	-	100	180	34	461.06
NU220W	-	100	180	34	506.82
NU220EM	-	100	180	34	793.48
NJ220ET	-	100	180	34	498.74
NJ220W	-	100	180	34	549.83
NJ220EM	-	100	180	34	883.04
NUP220ET	-	100	180	34	751.11
NUP220W	-	100	180	34	826.22
N220W	-	100	180	34	679.64
NU221W	-	105	190	36	782.42
NJ221W	-	105	190	36	621.14
N221M	-	105	190	36	1265.85
NU222W	-	110	200	38	642.23
NJ222W	-	110	200	38	768.80
N222W	-	110	200	38	903.39

Cylindrical Roller Bearings - metric  
 Metrische Zylinderrollenlager  
 Roulements à rouleaux cylindriques - métrique  
 Rodamientos de rodillos cilíndricos  
 Cuscinetti a rulli cilindrici  
 Cylindriska kullager - metriska

NSK	RHP	d	D	B	€
NU224W	-	120	215	40	746.09
NU224EM	-	120	215	40	1177.48
NJ224W	-	120	215	40	884.75
NJ224EM	-	120	215	40	1287.40
NUP224EM	-	120	215	40	1714.52
N224W	-	120	215	40	1094.55
N224M	-	120	215	40	1591.57
NU226W	-	130	230	40	922.24
NJ226W	-	130	230	40	1111.70
N226W	-	130	230	40	1075.40
N226M	-	130	230	40	1850.93
NU228W	-	140	250	42	1218.43
NU228M	-	140	250	42	1911.89
NJ228W	-	140	250	42	1402.58
NJ228M	-	140	250	42	2039.43
N228W	-	140	250	42	1773.37
NU230W	-	150	270	45	1519.90
NU230M	-	150	270	45	2020.00
NJ230W	-	150	270	45	1755.79
NJ230M	-	150	270	45	2553.80
N230W	-	150	270	45	1952.09
NU232M	-	160	290	48	2233.65
NJ232M	-	160	290	48	2542.68
N232M	-	160	290	48	2742.52
NU234M	-	170	310	52	2755.55
NJ234M	-	170	310	52	2955.58
NU236M	-	180	320	52	3069.77
NU240M	-	200	360	58	4896.38
NJ240M	-	200	360	58	4518.98
NJ244M	-	220	400	65	8081.85
NU248M	-	240	440	72	10090.45
NU252M	-	260	480	80	14813.99
NU304ET	-	20	52	15	61.57
NU304W	-	20	52	15	69.70
NJ304ET	-	20	52	15	67.81
NJ304W	-	20	52	15	76.69
N304W	-	20	52	15	97.86
NF304W	-	20	52	15	92.90
NU305ET	-	25	62	17	70.63
NJ305ET	-	25	62	17	76.57

Cylindrical Roller Bearings - metric  
 Metrische Zylinderrollenlager  
 Roulements à rouleaux cylindriques - métrique  
 Rodamientos de rodillos cilíndricos  
 Cuscinetti a rulli cilindrici  
 Cylindriska kullager - metriska

NSK	RHP	d	D	B	€
NUP305ET	-	25	62	17	91.42
N305W	-	25	62	17	119.07
NF305ET	-	25	62	17	93.65
NF305W	-	25	62	17	137.17
NU306ET	-	30	72	19	79.70
NU306EW	-	30	72	19	89.90
NJ306ET	-	30	72	19	95.92
NJ306EW	-	30	72	19	145.70
NUP306ET	-	30	72	19	106.18
N306ET	-	30	72	19	109.34
N306W	-	30	72	19	122.53
NF306ET	-	30	72	19	117.36
NF306W	-	30	72	19	176.46
NU307ET	-	35	80	21	95.58
NU307EW	-	35	80	21	105.04
NU307EM	-	35	80	21	232.40
NJ307ET	-	35	80	21	106.18
NUP307ET	-	35	80	21	123.00
NUP307EW	-	35	80	21	155.51
N307ET	-	35	80	21	126.60
N307W	-	35	80	21	141.89
NF307ET	-	35	80	21	129.87
NF307W	-	35	80	21	159.36
NU308ET	-	40	90	23	110.39
NU308EW	-	40	90	23	121.75
NU308EM	-	40	90	23	241.57
NJ308ET	-	40	90	23	127.63
NJ308EM	-	40	90	23	305.31
NUP308ET	-	40	90	23	145.75
N308ET	-	40	90	23	153.02
N308W	-	40	90	23	168.22
NF308W	-	40	90	23	178.57
NU309ET	-	45	100	25	137.08
NU309EW	-	45	100	25	155.25
NU309EM	-	45	100	25	293.35
NJ309ET	-	45	100	25	149.81
NJ309EM	-	45	100	25	308.49
NUP309ET	-	45	100	25	175.07
N309ET	-	45	100	25	186.04
N309W	-	45	100	25	204.75

Cylindrical Roller Bearings - metric  
 Metrische Zylinderrollenlager  
 Roulements à rouleaux cylindriques - métrique  
 Rodamientos de rodillos cilíndricos  
 Cuscinetti a rulli cilindrici  
 Cylindriska kullager - metriska

NSK	RHP	d	D	B	€
N309M	-	45	100	25	372.12
NF309W	-	45	100	25	206.51
NU310ET	-	50	110	27	161.66
NU310EW	-	50	110	27	185.07
NU310EM	-	50	110	27	347.54
NJ310ET	-	50	110	27	180.56
NJ310EW	-	50	110	27	198.24
NUP310ET	-	50	110	27	211.49
NUP310EW	-	50	110	27	230.29
N310ET	-	50	110	27	229.17
N310W	-	50	110	27	240.59
N310M	-	50	110	27	437.73
NF310ET	-	50	110	27	220.86
NF310W	-	50	110	27	242.45
NU311ET	-	55	120	29	190.97
NU311EW	-	55	120	29	215.92
NU311EM	-	55	120	29	374.54
NJ311ET	-	55	120	29	215.82
NUP311ET	-	55	120	29	243.04
NUP311EW	-	55	120	29	267.34
N311ET	-	55	120	29	255.50
N311W	-	55	120	29	281.19
NF311W	-	55	120	29	290.00
NU312ET	-	60	130	31	226.85
NU312W	-	60	130	31	256.46
NJ312ET	-	60	130	31	253.31
NJ312W	-	60	130	31	298.48
NUP312ET	-	60	130	31	292.66
NUP312W	-	60	130	31	325.16
N312ET	-	60	130	31	300.06
N312W	-	60	130	31	330.01
N312M	-	60	130	31	599.90
NF312W	-	60	130	31	411.16
NU313ET	-	65	140	33	264.92
NU313W	-	65	140	33	299.04
NJ313ET	-	65	140	33	305.34
NJ313W	-	65	140	33	360.26
NUP313ET	-	65	140	33	340.76
NUP313W	-	65	140	33	422.67
N313ET	-	65	140	33	348.41

Cylindrical Roller Bearings - metric  
 Metrische Zylinderrollenlager  
 Roulements à rouleaux cylindriques - métrique  
 Rodamientos de rodillos cilíndricos  
 Cuscinetti a rulli cilindrici  
 Cylindriska kullager - metriska

NSK	RHP	d	D	B	€
N313W	-	65	140	33	383.46
N313M	-	65	140	33	697.07
NF313W	-	65	140	33	440.67
NU314ET	-	70	150	35	319.70
NU314W	-	70	150	35	361.77
NU314EM	-	70	150	35	526.11
NJ314ET	-	70	150	35	361.26
NJ314W	-	70	150	35	426.39
NJ314EM	-	70	150	35	707.71
NUP314ET	-	70	150	35	413.83
NUP314W	-	70	150	35	459.48
N314W	-	70	150	35	492.02
N314M	-	70	150	35	994.45
NF314W	-	70	150	35	521.52
NU315ET	-	75	160	37	366.58
NU315W	-	75	160	37	474.04
NU315EM	-	75	160	37	596.33
NJ315ET	-	75	160	37	419.27
NJ315W	-	75	160	37	496.73
NUP315ET	-	75	160	37	512.28
NUP315W	-	75	160	37	568.99
N315W	-	75	160	37	583.46
N315M	-	75	160	37	1019.77
NF315W	-	75	160	37	607.52
NU316ET	-	80	170	39	436.43
NU316W	-	80	170	39	493.37
NU316EM	-	80	170	39	689.19
NJ316ET	-	80	170	39	489.02
NJ316W	-	80	170	39	647.25
NUP316ET	-	80	170	39	611.65
N316W	-	80	170	39	605.55
N316M	-	80	170	39	1133.69
NU317ET	-	85	180	41	497.63
NU317W	-	85	180	41	561.92
NU317EM	-	85	180	41	799.96
NJ317ET	-	85	180	41	574.05
NJ317W	-	85	180	41	637.84
NUP317W	-	85	180	41	830.55
N317W	-	85	180	41	628.50
N317M	-	85	180	41	1274.89



Cylindrical Roller Bearings - metric  
 Metrische Zylinderrollenlager  
 Roulements à rouleaux cylindriques - métrique  
 Rodamientos de rodillos cilíndricos  
 Cuscinetti a rulli cilindrici  
 Cylindriska kullager - metriska

NSK	RHP	d	D	B	€
NU318ET	-	90	190	43	580.44
NU318W	-	90	190	43	639.41
NJ318ET	-	90	190	43	723.90
NJ318W	-	90	190	43	794.11
NUP318ET	-	90	190	43	838.13
N318ET	-	90	190	43	721.97
N318W	-	90	190	43	832.25
N318M	-	90	190	43	1543.17
NU319ET	-	95	200	45	639.41
NU319W	-	95	200	45	704.49
NU319EM	-	95	200	45	1053.41
NJ319W	-	90	190	43	908.97
N319W	-	95	200	45	947.26
N319M	-	95	200	45	1890.76
NU320ET	-	100	215	47	799.38
NU320W	-	100	215	47	908.68
NU320EM	-	100	215	47	1241.33
NJ320ET	-	100	215	47	1007.50
NJ320W	-	100	215	47	1108.08
NUP320ET	-	100	215	47	1368.75
N320ET	-	100	215	47	1106.55
N320W	-	100	215	47	1229.20
N320M	-	100	215	47	2432.36
NU321W	-	105	225	49	1027.14
NJ321W	-	105	225	49	1287.19
N321W	-	105	225	49	1322.12
N321M	-	105	225	49	2019.12
NU322W	-	110	240	50	1188.27
NJ322W	-	110	240	50	1561.91
N322W	-	110	240	50	1510.90
N322M	-	110	240	50	2527.85
NU324W	-	120	260	55	1528.87
NJ324W	-	120	260	55	1909.21
N324W	-	120	260	55	1936.36
N324M	-	120	260	55	3299.79
NU326W	-	130	280	58	1858.97
NJ326W	-	130	280	58	2679.30
N326M	-	130	280	58	3926.73
NU328W	-	140	300	62	2904.49
NU328M	-	140	300	62	3035.31

Cylindrical Roller Bearings - metric  
 Metrische Zylinderrollenlager  
 Roulements à rouleaux cylindriques - métrique  
 Rodamientos de rodillos cilíndricos  
 Cuscinetti a rulli cilindrici  
 Cylindriska kullager - metriska

NSK	RHP	d	D	B	€
NJ328M	-	140	300	58	4611.19
N328M	-	140	300	62	4270.50
NF328M	-	140	300	62	5352.08
NU330W	-	150	320	65	3483.06
NU330M	-	150	320	65	3785.45
NJ330M	-	150	320	65	5454.39
NU334M	-	170	360	72	6597.72
NU336M	-	180	380	75	7737.11
NU338M	-	190	400	78	9141.94
NU340M	-	200	420	80	10689.38
NU405W	-	25	80	21	140.01
NJ405W	-	25	80	21	141.88
N405W	-	25	80	21	128.53
NU406W	-	30	90	23	193.89
NJ406W	-	30	90	23	220.03
NJ406M	-	30	90	23	309.25
N406W	-	30	90	23	179.04
NU407W	-	35	100	25	232.52
NJ407W	-	35	100	25	255.87
NJ407M	-	35	100	25	365.46
N407W	-	35	100	25	241.53
NU408W	-	40	110	27	277.81
NJ408W	-	40	110	27	426.63
NJ408M	-	40	110	27	905.51
NUP408M	-	40	110	27	412.36
N408W	-	40	110	27	307.91
NU409W	-	45	120	29	321.91
NU409M	-	45	120	29	465.21
NJ409W	-	45	120	29	429.84
NJ409M	-	45	120	29	554.09
NUP409W	-	45	120	29	326.43
N409W	-	45	120	29	318.58
NU410W	-	50	130	31	382.47
NJ410W	-	50	130	31	468.28
N410W	-	50	130	31	463.71
NF410W	-	50	130	31	510.49
NU411W	-	55	140	33	454.68
NJ411W	-	55	140	33	568.28
NU412W	-	60	150	35	519.56
NU412M	-	60	150	35	747.32

Cylindrical Roller Bearings - metric  
 Metrische Zylinderrollenlager  
 Roulements à rouleaux cylindriques - métrique  
 Rodamientos de rodillos cilíndricos  
 Cuscinetti a rulli cilindrici  
 Cylindriska kullager - metriska

NSK	RHP	d	D	B	€
NJ412W	-	60	150	35	599.28
NJ412M	-	60	150	35	823.19
N412W	-	60	150	35	522.77
NU413W	-	65	160	37	637.24
NJ413W	-	65	160	37	691.73
NJ413M	-	65	160	37	950.29
N413M	-	65	160	37	980.31
NU414W	-	70	180	42	811.25
NU414M	-	70	180	42	1490.20
NJ414W	-	70	180	42	867.19
NJ414M	-	70	180	42	1213.99
N414W	-	70	180	42	760.29
N414M	-	70	180	42	1486.14
NU415W	-	75	190	45	956.69
NJ415W	-	75	190	45	978.00
NU416W	-	80	200	48	1124.06
NJ416W	-	80	200	48	1158.51
NJ416M	-	80	200	48	1605.79
NU417M	-	85	210	52	2244.73
NJ417M	-	85	210	52	1766.27
NJ418M	-	90	225	54	2167.53
NU418M	-	90	225	54	2570.54
NU419M	-	95	240	55	2895.55
NU420M	-	100	250	58	3403.25
NJ421M	-	105	260	60	3169.72
NU421M	-	105	260	60	3906.60
NJ422M	-	110	280	65	3814.65
NU1005M	-	25	47	12	117.86
NU1006M	-	30	55	13	87.72
NU1007M	-	35	62	14	112.71
NU1008M	-	40	68	15	195.15
NU1009M	-	45	75	16	213.35
NU1010M	-	50	80	16	223.92
NU1012M	-	60	95	18	284.74
NU1013M	-	65	100	18	327.50
NU1014M	-	70	110	20	363.23
NU1015M	-	75	115	20	375.81
NU1016M	-	80	125	22	409.24
NU1017M	-	85	130	22	466.82
NU1018M	-	90	140	24	476.72

Cylindrical Roller Bearings - metric  
 Metrische Zylinderrollenlager  
 Roulements à rouleaux cylindriques - métrique  
 Rodamientos de rodillos cilíndricos  
 Cuscinetti a rulli cilindrici  
 Cylindriska kullager - metriska

NSK	RHP	d	D	B	€
NU1019M	-	95	145	24	511.22
NU1020M	-	100	150	24	544.24
NU1021M	-	105	160	26	636.67
NU1022M	-	110	170	28	691.36
NU1024M	-	120	180	28	782.52
NU1026M	-	130	200	33	947.04
NU1028M	-	140	210	33	1118.72
NU1030M	-	150	225	35	1278.91
NU1032M	-	160	240	38	1560.08
NU1034M	-	170	260	42	1914.00
NU1038M	-	190	290	46	2607.83
NU1040M	-	200	310	51	2906.58
NU1048M	-	240	360	56	4970.07
NU1052M	-	260	400	65	6683.74
NU1056M	-	280	420	65	7305.93
NU1060M	-	300	460	74	10924.23
NU1064M	-	320	480	74	12710.31
NU1068M	-	340	520	82	15761.66
NU2204W	-	20	47	18	74.73
NJ2204W	-	20	47	18	90.02
NU2205ET	-	25	52	18	68.52
NU2205W	-	25	52	18	77.57
NJ2205ET	-	25	52	18	77.93
NJ2205W	-	25	52	18	88.22
NUP2205ET	-	25	52	18	87.10
NUP2205W	-	25	52	18	98.63
N2205W	-	25	52	18	72.71
NU2206ET	-	30	62	20	82.37
NU2206W	-	30	62	20	92.34
NJ2206ET	-	30	62	20	91.09
NJ2206W	-	30	62	20	100.14
NUP2206ET	-	30	62	20	102.92
NUP2206W	-	30	62	20	135.61
NU2207ET	-	35	72	23	94.07
NU2207W	-	35	72	23	128.28
NJ2207ET	-	35	72	23	102.68
NJ2207W	-	35	72	23	123.38
NUP2207ET	-	35	72	23	117.45
NUP2207W	-	35	72	23	139.65
NU2208ET	-	40	80	23	109.78

Cylindrical Roller Bearings - metric  
 Metrische Zylinderrollenlager  
 Roulements à rouleaux cylindriques - métrique  
 Rodamientos de rodillos cilíndricos  
 Cuscinetti a rulli cilindrici  
 Cylindriska kullager - metriska

NSK	RHP	d	D	B	€
NU2208W	-	40	80	23	141.58
NJ2208ET	-	40	80	23	123.82
NJ2208W	-	40	80	23	145.87
NUP2208ET	-	40	80	23	143.91
NUP2208W	-	40	80	23	162.94
N2208W	-	40	80	23	118.17
NU2209ET	-	45	85	23	122.65
NU2209W	-	45	85	23	139.39
NJ2209ET	-	45	85	23	135.48
NJ2209W	-	45	85	23	164.44
NUP2209ET	-	45	85	23	149.85
NUP2209W	-	45	85	23	169.71
N2209ET	-	45	85	23	119.43
NU2210ET	-	50	90	23	133.65
NU2210W	-	50	90	23	155.70
NJ2210ET	-	50	90	23	146.20
NJ2210W	-	50	90	23	172.20
NUP2210ET	-	50	90	23	165.58
NU2211ET	-	55	100	25	157.81
NU2211W	-	55	100	25	189.68
NJ2211ET	-	55	100	25	173.68
NJ2211W	-	55	100	25	273.04
NUP2211ET	-	55	100	25	194.27
NUP2211W	-	55	100	25	215.60
NU2212ET	-	60	110	28	184.76
NU2212W	-	60	110	28	208.56
NJ2212ET	-	60	110	28	207.69
NJ2212W	-	60	110	28	244.87
NUP2212ET	-	60	110	28	228.88
NUP2212W	-	60	110	28	306.48
NU2213ET	-	65	120	31	218.13
NU2213W	-	65	120	31	264.01
NJ2213ET	-	65	120	31	237.08
NJ2213W	-	65	120	31	280.05
NJ2213M	-	65	120	31	410.69
NUP2213ET	-	65	120	31	269.47
NUP2213W	-	65	120	31	299.28
NU2214ET	-	70	125	31	243.77
NU2214W	-	70	125	31	389.23
NJ2214ET	-	70	125	31	259.83

Cylindrical Roller Bearings - metric  
 Metrische Zylinderrollenlager  
 Roulements à rouleaux cylindriques - métrique  
 Rodamientos de rodillos cilíndricos  
 Cuscinetti a rulli cilindrici  
 Cylindriska kullager - metriska

NSK	RHP	d	D	B	€
NJ2214W	-	70	125	31	309.44
NUP2214ET	-	70	125	31	304.78
NUP2214W	-	70	125	31	338.62
NU2215ET	-	75	130	31	263.47
NU2215W	-	75	130	31	368.42
NJ2215ET	-	75	130	31	287.17
NJ2215W	-	75	130	31	372.09
NUP2215ET	-	75	130	31	332.48
NU2216ET	-	80	140	33	312.07
NU2216W	-	80	140	33	346.48
NJ2216ET	-	80	140	33	337.77
NJ2216W	-	80	140	33	399.09
NUP2216ET	-	80	140	33	388.36
NU2217ET	-	85	150	36	368.71
NU2217W	-	85	150	36	405.90
NJ2217ET	-	85	150	36	394.98
NJ2217W	-	85	150	36	470.21
NUP2217ET	-	85	150	36	465.06
NU2218ET	-	90	160	40	431.66
NU2218W	-	90	160	40	475.71
NU2218M	-	90	160	40	839.03
NJ2218ET	-	90	160	40	476.38
NJ2218W	-	90	160	40	561.96
NUP2218M	-	90	160	40	963.37
NU2219ET	-	95	170	43	511.06
NU2219W	-	95	170	43	635.71
NU2219M	-	95	170	43	1079.42
NJ2219W	-	95	170	43	687.31
NU2220W	-	100	180	46	982.71
NU2220M	-	100	180	46	1112.48
NJ2220ET	-	100	180	46	678.26
NJ2220W	-	100	180	46	799.70
NUP2220M	-	100	180	46	1503.42
NU2222W	-	110	200	53	1009.29
NU2222M	-	110	200	53	1551.00
NJ2222W	-	110	200	53	1105.86
NJ2222M	-	110	200	53	1608.43
NUP2222M	-	110	200	53	2244.17
NU2224W	-	120	215	58	1161.28
NU2224M	-	120	215	58	1846.40

Cylindrical Roller Bearings - metric  
 Metrische Zylinderrollenlager  
 Roulements à rouleaux cylindriques - métrique  
 Rodamientos de rodillos cilíndricos  
 Cuscinetti a rulli cilindrici  
 Cylindriska kullager - metriska

NSK	RHP	d	D	B	€
NJ2224W	-	120	215	58	1470.45
NJ2224M	-	120	215	58	2309.99
NU2226W	-	130	230	64	1278.80
NU2226M	-	130	230	64	1948.17
NJ2226W	-	130	230	64	1801.48
NJ2226M	-	130	230	64	2671.42
NU2228W	-	140	250	68	1603.01
NU2228M	-	140	250	68	2564.46
NJ2228W	-	140	250	68	2214.09
NJ2228M	-	140	250	68	3284.84
NU2230M	-	150	270	73	2973.54
NJ2230M	-	150	270	73	3913.29
NU2234M	-	170	310	86	4673.83
NU2236M	-	180	320	86	5394.89
NU2238M	-	190	340	92	7933.85
NU2240M	-	200	360	98	9187.33
NU2305ET	-	25	62	24	93.35
NU2305W	-	25	62	24	105.60
NJ2305ET	-	25	62	24	99.68
NJ2305W	-	25	62	24	147.83
NUP2305ET	-	25	62	24	154.11
NUP2305W	-	25	62	24	171.25
NU2306ET	-	30	72	27	113.98
NU2306W	-	30	72	27	129.05
NJ2306ET	-	30	72	27	121.82
NJ2306W	-	30	72	27	137.92
NUP2306ET	-	30	72	27	182.37
NUP2306W	-	30	72	27	202.61
NU2307ET	-	35	80	31	133.11
NU2307W	-	35	80	31	150.64
NJ2307ET	-	35	80	31	142.77
NJ2307W	-	35	80	31	161.54
NUP2307ET	-	35	80	31	165.58
NUP2307W	-	35	80	31	183.86
NU2308ET	-	40	90	33	160.31
NU2308W	-	40	90	33	176.42
NJ2308ET	-	40	90	33	174.35
NJ2308W	-	40	90	33	192.38
NUP2308ET	-	40	90	33	203.98
NUP2308W	-	40	90	33	274.15

Cylindrical Roller Bearings - metric  
 Metrische Zylinderrollenlager  
 Roulements à rouleaux cylindriques - métrique  
 Rodamientos de rodillos cilíndricos  
 Cuscinetti a rulli cilindrici  
 Cylindriska kullager - metriska

NSK	RHP	d	D	B	€
NU2309ET	-	45	100	36	197.02
NU2309W	-	45	100	36	222.24
NJ2309ET	-	45	100	36	211.76
NJ2309W	-	45	100	36	239.60
NUP2309ET	-	45	100	36	246.88
NU2310ET	-	50	110	40	241.63
NU2310W	-	50	110	40	268.30
NU2310M	-	50	110	40	411.47
NJ2310ET	-	50	110	40	263.47
NJ2310W	-	50	110	40	292.77
NUP2310ET	-	50	110	40	301.77
NUP2310W	-	50	110	40	335.11
NU2311ET	-	55	120	43	299.63
NU2311W	-	55	120	43	332.74
NJ2311W	-	55	120	43	310.89
NU2312ET	-	60	130	46	360.38
NU2312W	-	60	130	46	400.43
NJ2312W	-	60	130	46	373.08
NUP2312W	-	60	130	46	510.67
NU2313ET	-	65	140	48	442.34
NU2313W	-	65	140	48	491.30
NU2313EM	-	65	140	48	848.58
NJ2313W	-	65	140	48	453.29
NU2314ET	-	70	150	51	513.93
NU2314W	-	70	150	51	570.74
NJ2314ET	-	70	150	51	548.83
NJ2314W	-	70	150	51	609.43
NUP2314W	-	70	150	51	705.58
NU2315ET	-	75	160	55	635.36
NU2315W	-	75	160	55	853.29
NJ2315W	-	75	160	55	710.64
NUP2315ET	-	75	160	55	935.04
NU2316ET	-	80	170	58	705.49
NU2316W	-	80	170	58	962.90
NJ2316W	-	80	170	58	767.49
NU2317W	-	85	180	60	1084.55
NJ2317W	-	85	180	60	890.30
NU2318W	-	90	190	64	1159.19
NU2318M	-	90	190	64	2379.78
NJ2318W	-	90	190	64	1231.84



Cylindrical Roller Bearings - metric  
 Metrische Zylinderrollenlager  
 Roulements à rouleaux cylindriques - métrique  
 Rodamientos de rodillos cilíndricos  
 Cuscinetti a rulli cilindrici  
 Cylindriska kullager - metriska

NSK	RHP	d	D	B	€
NJ2318M	-	90	190	64	1699.07
NU2319W	-	95	200	67	1245.84
NU2319M	-	95	200	67	1689.48
NJ2319W	-	95	200	67	1390.36
NUP2319M	-	95	200	67	3944.81
NU2320W	-	100	215	73	1670.71
NU2320M	-	100	215	73	2342.45
NJ2320W	-	100	215	73	1661.20
NJ2320M	-	100	215	73	2309.07
NU2322M	-	110	240	80	2780.24
NJ2322M	-	110	240	80	3130.32
NU2324M	-	120	260	86	3979.42
NJ2324M	-	120	260	86	4557.77
NU2326M	-	130	280	93	4837.11
NU2328M	-	140	300	102	6975.92
NU2330M	-	150	320	108	8494.90
NU2332M	-	160	340	114	9308.23
NCF2914V	-	70	100	19	164.13
NCF2916V	-	80	110	19	203.24
NCF2918V	-	90	125	22	268.41
NCF2920V	-	100	140	24	357.60
NCF2922V	-	110	150	24	394.82
NCF2924V	-	120	165	27	455.43
NCF2926V	-	130	180	30	524.67
NCF2928V	-	140	190	30	597.42
NCF2930V	-	150	210	36	758.47
NCF2932V	-	160	220	36	864.11
NCF2934V	-	170	230	36	922.98
NCF2936V	-	180	250	42	1142.90
NCF2938V	-	190	260	42	1232.93
NCF2940V	-	200	280	48	1461.53
NCF2944V	-	220	300	48	1768.02
NCF2948V	-	240	320	48	2136.88
NCF2952V	-	260	360	60	2970.08
NCF2956V	-	280	380	60	3479.46
NCF2960V	-	300	420	72	5002.23
NCF2964V	-	320	440	72	6739.17
NCF2968V	-	340	460	72	8430.69
NCF2972V	-	360	480	72	9291.22
NCF2976V	-	380	520	82	11339.72

Cylindrical Roller Bearings - metric  
 Metrische Zylinderrollenlager  
 Roulements à rouleaux cylindriques - métrique  
 Rodamientos de rodillos cilíndricos  
 Cuscinetti a rulli cilindrici  
 Cylindriska kullager - metriska

NSK	RHP	d	D	B	€
NCF3020V	-	100	150	37	542.74
NCF3024V	-	120	180	46	839.56
NCF3030V	-	150	225	56	1187.32
NCF3032V	-	160	240	60	1391.08
NCF3038V	-	190	290	75	2494.10
NCF3040V	-	200	310	82	2957.78
NCF3044V	-	220	340	90	3778.01
NCF3048V	-	240	360	92	4436.69
NCF3052V	-	260	400	104	6092.95
NCF3056V	-	280	420	106	7004.55
NCF3068V	-	340	520	133	16658.20
NNCF5015V	-	75	115	54	461.54
NNCF5018V	-	90	140	67	725.58
NNCF5020V	-	100	150	67	936.84
RS-5008DSE7NAS5	-	40	68	37	324.72
RS-5009DSE7NAS5	-	45	75	39	521.56
RS-5010DSE7NAS5	-	50	80	39	374.65
RS-5011DSE7NAS5	-	55	90	45	415.08
RS-5012DSE7NAS5	-	60	95	45	645.96
RS-5013DSE7NAS5	-	65	100	45	501.01
RS-5014DSE7NAS5	-	70	110	53	563.17
RS-5015DSE7NAS5	-	75	115	53	663.78
RS-5016DSE7NAS5	-	80	125	59	773.98
RS-5017DSE7NAS5	-	85	130	59	854.67
RS-5018DSE7NAS5	-	90	140	66	938.49
RS-5022DSE7NAS5	-	110	170	79	1770.28
RS-5024DSE7NAS5	-	120	180	79	1431.77
RS-5026DSE7NAS5	-	130	200	94	2572.09
RS-5028DSE7NAS5	-	140	210	94	3364.11
RS-5030DSE7NAS5	-	150	225	99	4415.65
RS-5032DSE7NAS5	-	160	240	108	4742.78
RS-5036DSE7NAS5	-	180	280	135	6811.17

**Cylindrical Roller Bearings - inch**

**Zöllige Zylinderrollenlager**

**Roulements à rouleaux cylindriques - pouce**

**Rodamientos de rodillos cilíndricos serie pulgadas**

**Cuscinetti a rulli cilindrici - dimensioni in pollici**

**Cylindriska kullager - tum**

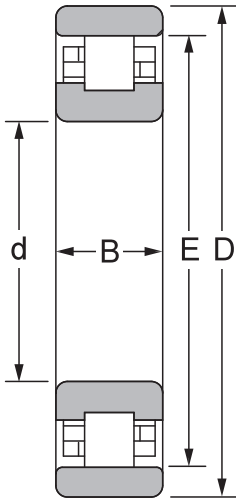

- RJ

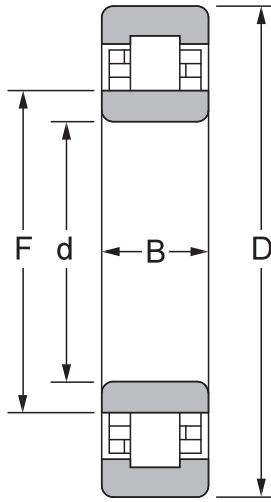

-- RJ

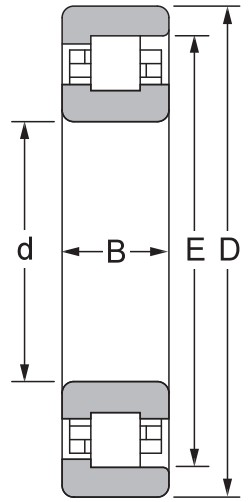

- RJA

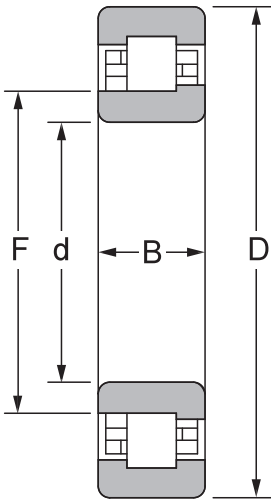

-- RJA

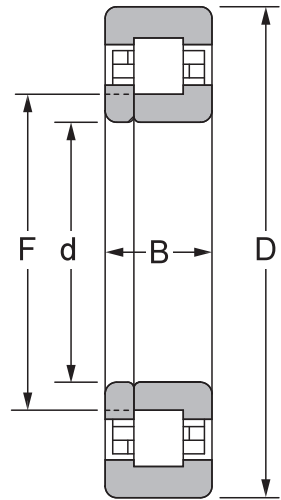

-- RJB

Cylindrical Roller Bearings - inch  
 Zöllige Zylinderrollenlager  
 Roulements à rouleaux cylindriques - pouce  
 Rodamientos de rodillos cilíndricos serie pulgadas  
 Cuscinetti a rulli cilindrici - dimensioni in pollici  
 Cylindriska kullager - tum

NSK	RHP	d	D	B	€
-	XLRJA3.1/2M	3.1/2	5	3/4	*
-	LRJ5/8J	5/8	1.9/16	7/16	*
-	LRJ3/4J	3/4	1.7/8	9/16	*
-	LRJA7/8J	7/8	2	9/16	*
-	LRJ7/8J	7/8	2	9/16	*
-	LRJA1J	1	2.1/4	5/8	*
-	LRJ1J	1	2.1/4	5/8	*
-	LRJA1.1/8J	1.1/8	2.1/2	5/8	*
-	LRJ1.1/8J	1.1/8	2.1/2	5/8	*
-	LRJ1.1/4J	1.1/4	2.3/4	11/16	*
-	LRJ1.3/8J	1.3/8	3	11/16	*
-	LRJ1.1/2J	1.1/2	3.1/4	3/4	*
-	LRJ1.1/2M	1.1/2	3.1/4	3/4	*
-	LRJ1.3/4J	1.3/4	3.3/4	13/16	*
-	LRJ1.7/8J	1.7/8	4	13/16	*
-	LRJA2J	2	4	13/16	*
-	LRJ2J	2	4	13/16	*
-	LRJ2.1/4J	2.1/4	4.1/2	7/8	*
-	LRJA2.1/2J	2.1/2	5	15/16	*
-	LRJ2.1/2J	2.1/2	5	15/16	*
-	LRJA2.3/4J	2.3/4	5.1/4	15/16	*
-	LRJ2.3/4J	2.3/4	5.1/4	15/16	*
-	LRJA3J	3	5.3/4	1.1/16	*
-	LRJ3J	3	5.3/4	1.1/16	*
-	LRJA3.1/4M	3.1/4	6	1.1/16	*
-	LRJ3.1/4M	3.1/4	6	1.1/16	*
-	LRJA3.1/2J	3.1/2	6.1/2	1.1/8	*
-	LRJ3.1/2J	3.1/2	6.1/2	1.1/8	*
-	LRJA3.3/4M	3.3/4	6.3/4	1.1/8	*
-	LRJA4M	4	7.1/4	1.1/4	*
-	LRJ4M	4	7.1/4	1.1/4	*
-	LRJ4.1/4M	4.1/4	7.1/2	1.1/4	*
-	LRJA4.1/2M	4.1/2	8	1.5/16	*
-	LRJ4.1/2M	4.1/2	8	1.5/16	*
-	LRJ4.3/4M	4.3/4	8.1/4	1.5/16	*
-	LRJA5M	5	9	1.3/8	*
-	LRJ5M	5	9	1.3/8	*
-	LRJA5.1/2M	5.1/2	9.1/2	1.3/8	*
-	LRJ5.1/2M	5.1/2	9.1/2	1.3/8	*
-	LRJA6M	6	10.1/2	1.9/16	*

Cylindrical Roller Bearings - inch  
 Zöllige Zylinderrollenlager  
 Roulements à rouleaux cylindriques - pouce  
 Rodamientos de rodillos cilíndricos serie pulgadas  
 Cuscinetti a rulli cilindrici - dimensioni in pollici  
 Cylindriska kullager - tum

NSK	RHP	d	D	B	€
-	LRJ6M	6	10.1/2	1.9/16	*
-	LRJA6.1/2M	6.1/2	11	1.9/16	*
-	LRJ6.1/2M	6.1/2	11	1.9/16	*
-	LRJA7M	7	12	1.3/4	*
-	LRJ7M	7	12	1.3/4	*
-	MRJ1J	1	2.1/2	3/4	*
-	MMRJ1.1/8J	1.1/8	2.13/16	13/16	*
-	MRJA1.1/8J	1.1/8	2.13/16	13/16	*
-	MRJ1.1/8J	1.1/8	2.13/16	13/16	*
-	MRJA1.1/4J	1.1/4	3.1/8	7/8	*
-	MRJ1.1/4J	1.1/4	3.1/8	7/8	*
-	MRJ1.3/8J	1.3/8	3.1/2	7/8	*
-	MRJ1.1/2J	1.1/2	3.3/4	15/16	*
-	MRJ1.3/4J	1.3/4	4.1/4	1.1/16	*
-	MMRJ2J	2	4.1/2	1.1/16	*
-	MRJA2J	2	4.1/2	1.1/16	*
-	MRJ2J	2	4.1/2	1.1/16	*
-	MRJ2.1/4J	2.1/4	5	1.1/4	*
-	MRJ2.1/2J	2.1/2	5.1/2	1.1/4	*
-	MRJA2.3/4EM	2.3/4	6.1/4	1.3/8	*
-	MRJ2.3/4EM	2.3/4	6.1/4	1.3/8	*
-	MRJ3J	3	7	1.9/16	*
-	MRJ3.1/4J	3.1/4	7.1/2	1.9/16	*
-	MRJ3.3/8J	3.3/8	7.1/2	1.9/16	*
-	MRJ3.1/2EM	3.1/2	8.1/8	1.3/4	*
-	MRJ3.3/4EM	3.3/4	8.1/4	1.3/4	*
-	MRJ4EM	4	8.1/2	1.3/4	*
-	MRJA4.1/4EM	4.1/4	8.3/4	1.3/4	*
-	MRJ4.1/4EM	4.1/4	8.3/4	1.3/4	*
-	MRJA4.1/2EM	4.1/2	9.3/8	2	*
-	MRJ4.1/2EM	4.1/2	9.3/8	2	*
-	MRJ4.3/4EM	4.3/4	10	2	*
-	MRJ5EM	5	10	2	*
-	MRJ5.1/2EM	5.1/2	11	2	*
-	MRJ6EM	6	12	2.1/4	*
-	MRJ6.1/2EM	6.1/2	13	2.1/2	*



**Spherical Roller Bearings**

**Pendelrollenlager**

**Roulements à rouleaux sphériques**

**Rodamientos de rodillos esféricos**

**Cuscinetti orientabili a due corone di rulli**

**Sfäriska rullager**

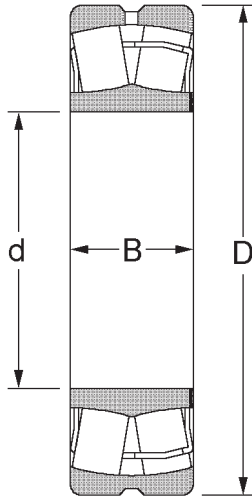



Spherical Roller Bearings  
 Pendelrollenlager  
 Roulements à rouleaux sphériques  
 Rodamientos de rodillos esféricos  
 Cuscinetti orientabili a due corone di rulli  
 Sfäriska rullager

NSK	RHP	d	D	B	€
21304CDE4	-	20	52	15	150.59
21305CDE4	21305J	25	62	17	139.17
21305CDKE4	-	25	62	17	146.04
21306CDE4	21306J	30	72	19	158.03
21306CDKE4	-	30	72	19	165.81
21307CDE4	21307J	35	80	21	172.82
21307CDKE4	-	35	80	21	181.32
21308EAE4***	21308J	40	90	23	188.42
21308EAKE4***	21308KJ	40	90	23	198.73
21309EAE4***	21309J	45	100	25	202.38
21309EAKE4***	21309KJ	45	100	25	212.36
21310EAE4***	21310J	50	110	27	232.68
21310EAKE4***	21310KJ	50	110	27	244.13
21311EAE4***	21311J	55	120	29	272.25
21311EAKE4***	21311KJ	55	120	29	280.28
21312EAE4***	21312J	60	130	31	307.24
21312EAKE4***	21312KJ	60	130	31	322.38
21313EAE4***	21313J	65	140	33	360.56
21313EAKE4***	21313KJ	65	140	33	371.21
21314EAE4***	21314J	70	150	35	426.52
21314EAKE4***	21314KJ	70	150	35	436.75
21315EAE4***	21315J	75	160	37	464.16
21315EAKE4***	21315KJ	75	160	37	487.02
21316EAE4***	21316J	80	170	39	522.75
21316EAKE4***	21316KJ	80	170	39	548.46
21317EAE4***	-	85	180	41	592.66
21317EAKE4***	-	85	180	41	604.15
-	21317M	85	180	41	592.66
-	21317KM	85	180	41	604.15
21318EAE4***	-	90	190	43	675.07
21318EAKE4***	-	90	190	43	675.07
-	21318M	90	190	43	675.07
-	21318KM	90	190	43	675.07
21319CKE4	-	95	200	45	824.61
21322CAME4	-	110	240	50	1329.98
22205CE4	22205EJW33	25	52	18	128.17
22205CKE4	22205EKJW33	25	52	18	128.71
22206CE4	22206EJW33	30	62	20	129.38
22206CKE4	22206EKJW33	30	62	20	129.38
22207CE4	22207EJW33	35	72	23	134.39

Spherical Roller Bearings  
 Pendelrollenlager  
 Roulements à rouleaux sphériques  
 Rodamientos de rodillos esféricos  
 Cuscinetti orientabili a due corone di rulli  
 Sfäriska rullager

NSK	RHP	d	D	B	€
22207CKE4	22207EKJW33	35	72	23	134.39
22208EAE4***	22208EJW33	40	80	23	145.45
22208EAKE4***	22208EKJW33	40	80	23	145.45
22209EAE4***	22209EJW33	45	85	23	153.34
22209EAKE4***	22209EKJW33	45	85	23	153.34
22210EAE4***	22210EJW33	50	90	23	162.45
22210EAKE4***	22210EKJW33	50	90	23	162.45
22211EAE4***	22211EJW33	55	100	25	180.05
22211EAKE4***	22211EKJW33	55	100	25	180.05
22212EAE4***	22212EJW33	60	110	28	203.62
22212EAKE4***	22212EKJW33	60	110	28	203.62
22213EAE4***	22213EJW33	65	120	31	239.35
22213EAKE4***	22213EKJW33	65	120	31	239.35
22214EAE4***	22214EJW33	70	125	31	273.84
22214EAKE4***	22214EKJW33	70	125	31	273.84
22215EAE4***	22215EJW33	75	130	31	300.56
22215EAKE4***	22215EKJW33	75	130	31	300.56
22216EAE4***	22216EJW33	80	140	33	341.01
22216EAKE4***	22216EKJW33	80	140	33	341.01
22217EAE4***	22217EJW33	85	150	36	392.68
22217EAKE4***	22217EKJW33	85	150	36	392.68
22218EAE4***	22218EJW33	90	160	40	456.73
22218EAKE4***	22218EKJW33	90	160	40	456.73
22219EAE4***	22219EJW33	95	170	43	543.79
22219EAKE4***	22219EKJW33	95	170	43	543.79
22220EAE4***	22220EJW33	100	180	46	611.61
22220EAKE4***	22220EKJW33	100	180	46	611.61
22222EAE4***	22222EJW33	110	200	53	752.43
22222EAKE4***	22222EKJW33	110	200	53	752.43
22224EAE4***	22224EJW33	120	215	58	995.64
22224EAKE4***	22224EKJW33	120	215	58	995.64
22226EAE4***	22226EJW33	130	230	64	1206.72
22226EAKE4***	22226EKJW33	130	230	64	1206.72
22228CDE4	22228EJW33	140	250	68	1522.65
22228CDKE4	22228EKJW33	140	250	68	1522.65
22230CDE4	-	150	270	73	1903.48
22230CDKE4	-	150	270	73	1903.48
22232CDE4	-	160	290	80	2230.35
22232CDKE4	-	160	290	80	2230.35
22234CDE4	-	170	310	86	3071.52

Spherical Roller Bearings  
 Pendelrollenlager  
 Roulements à rouleaux sphériques  
 Rodamientos de rodillos esféricos  
 Cuscinetti orientabili a due corone di rulli  
 Sfäriska rullager

NSK	RHP	d	D	B	€
22234CDKE4	-	170	310	86	3071.52
22236CDE4	-	180	320	86	3400.47
22236CDKE4	-	180	320	86	3400.47
22238CAME4	22238EMW33	190	340	92	4152.99
22238CAMKE4	22238EKMW33	190	340	92	4152.99
22240CAME4	22240EMW33	200	360	98	4932.06
22240CAMKE4	22240EKMW33	200	360	98	4932.06
22244CAME4	22244EMW33	220	400	108	6554.96
22244CAMKE4	22244EKMW33	220	400	108	6554.96
22248CAME4	-	240	440	120	11074.69
22252CAMKE4	-	260	480	130	16195.22
22256CAME4	-	280	500	130	19764.59
22256CAMKE4	-	280	500	130	19764.59
22260CAME4	-	300	540	140	24557.56
22264CAMKE4	-	320	580	150	30216.69
22308EAE4***	22308EJW33	40	90	33	203.62
22308EAKE4***	22308EKJW33	40	90	33	207.49
22308CAME4C4VE	22308VEC4	40	90	33	266.55
22309EAE4***	22309EJW33	45	100	36	232.96
22309EAKE4***	22309EKJW33	45	100	36	232.96
22309CAME4C4VE	22309VEC4	45	100	36	303.59
22310EAE4***	22310EJW33	50	110	40	273.26
22310EAKE4***	22310EKJW33	50	110	40	273.26
22310CAME4C4VE	22310VEC4	50	110	40	356.35
22311EAE4***	22311EJW33	55	120	43	320.80
22311EAKE4***	22311EKJW33	55	120	43	320.80
22311CAME4C4VE	22311VEC4	55	120	43	419.67
22312EAE4***	22312EJW33	60	130	46	372.46
22312EAKE4***	22312EKJW33	60	130	46	372.46
22312CAME4C4VE	22312VEC4	60	130	46	484.99
22313EAE4***	22313EJW33	65	140	48	433.17
22313EAKE4***	22313EKJW33	65	140	48	433.17
22313CAME4C4VE	22313VEC4	65	140	48	566.36
22314EAE4***	22314EJW33	70	150	51	496.80
22314EAKE4***	22314EKJW33	70	150	51	496.80
22314CAME4C4VE	22314VEC4	70	150	51	634.93
22315EAE4***	22315EJW33	75	160	55	579.70
22315EAKE4***	22315EKJW33	75	160	55	579.70
22315CAME4C4VE	22315VEC4	75	160	55	710.69
22316EAE4***	22316EJW33	80	170	58	657.62

Spherical Roller Bearings  
 Pendelrollenlager  
 Roulements à rouleaux sphériques  
 Rodamientos de rodillos esféricos  
 Cuscinetti orientabili a due corone di rulli  
 Sfäriska rullager

NSK	RHP	d	D	B	€
22316EAKE4***	22316EKJW33	80	170	58	657.62
-	22316KVEC4	80	170	58	821.22
-	22316EKMW33	80	170	58	657.62
22316CAME4C4VE	22316VEC4	80	170	58	821.22
22317EAE4***	22317EJW33	85	180	60	761.58
22317EAKE4***	22317EKJW33	85	180	60	761.58
22317CAME4C4VE	22317VEC4	85	180	60	901.18
22318EAE4***	22318EJW33	90	190	64	834.93
22318EAKE4***	22318EKJW33	90	190	64	834.93
22318CAME4C4VE	22318VEC4	90	190	64	992.65
22319EAE4***	22319EJW33	95	200	67	1025.36
22319EAKE4***	22319EKJW33	95	200	67	1025.36
22319CAME4C4VE	22319VEC4	95	200	67	1301.15
22320EAE4***	22320EJW33	100	215	73	1230.12
22320EAKE4***	-	100	215	73	1230.12
22320CAME4C4VE	22320VEC4	100	215	73	1481.78
-	22320KVEC4	100	215	73	1481.78
22322EAE4***	-	110	240	80	1653.15
22322EAKE4***	-	110	240	80	1653.15
-	22322EMW33	110	240	80	1653.15
-	22322EKMW33	110	240	80	1653.15
22322CAME4C4VE	22322VEC4	110	240	80	1983.64
-	22322KVEC4	110	240	80	1983.64
22324EAE4***	-	120	260	86	2121.85
22324EAKE4	-	120	260	86	2121.85
22324CAME4	22324EMW33	120	260	86	2121.85
22324CAMKE4	22324EKMW33	120	260	86	2121.85
22324CAME4C4VE	22324VEC4	120	260	86	2483.44
22326CAME4	22326EMW33	130	280	93	2597.31
22326CAMKE4	22326EKMW33	130	280	93	2597.31
22326CAME4C4VE	22326VEC4	130	280	93	3040.03
-	22328EKVBC4	140	300	102	3919.63
22328CAME4	22328EMW33	140	300	102	3239.87
22328CAMKE4	22328EKMW33	140	300	102	3239.87
22328CAME4C4VE	22328VEC4	140	300	102	3919.63
22330CAME4	22330EMW33	150	320	108	4141.36
22330CAMKE4	22330EKMW33	150	320	108	4221.78
22330CAME4C4VE	22330VEC4	150	320	108	4934.26
22332CAME4	22332EMW33	160	340	114	4683.60
22332CAMKE4	22332EKMW33	160	340	114	4686.34

Spherical Roller Bearings  
 Pendelrollenlager  
 Roulements à rouleaux sphériques  
 Rodamientos de rodillos esféricos  
 Cuscinetti orientabili a due corone di rulli  
 Sfäriska rullager

NSK	RHP	d	D	B	€
22332CAME4C4VE	22332VEC4	160	340	114	6248.45
22334CAME4	22334EMW33	170	360	120	5473.09
22334CAMKE4	22334EKMW33	170	360	120	5473.09
22336CAME4	-	180	380	126	6945.52
22338CAME4	-	190	400	132	8465.12
22338CAMKE4	-	190	400	132	8465.12
22340CAME4	-	200	420	138	9652.89
22340CAMKE4	-	200	420	138	9652.86
22340CAME4C4VE	-	200	420	138	12326.97
22344CAME4	-	220	460	145	15494.83
23022CDE4	23022EJW33	110	170	45	656.47
23022CDKE4	-	110	170	45	656.47
23024CDE4	23024EJW33	120	180	46	763.88
23024CDKE4	23024EKJW33	120	180	46	763.88
23026CDE4	23026EJW33	130	200	52	985.19
23026CDKE4	23026EKJW33	130	200	52	985.19
23028CDE4	23028EJW33	140	210	53	1119.40
23028CDKE4	23028EKJW33	140	210	53	1119.40
23030CDE4	-	150	225	56	1283.22
23030CAME4	23030EMW33	150	225	56	1283.22
-	23030EKMW33	150	225	56	1283.22
23032CDE4	-	160	240	60	1531.33
23032CDKE4	-	160	240	60	1531.33
23032CAME4	23032EMW33	160	240	60	1531.33
-	23032EKMW33	160	240	60	1531.33
23034CDE4	-	170	260	67	1794.10
23034CDKE4	-	170	260	67	1794.10
23034CAME4	23034EMW33	170	260	67	1794.10
-	23034EKMW33	170	260	67	1794.10
23036CDE4	-	180	280	74	2101.63
23036CDKE4	-	180	280	74	2101.63
-	23036EMW33	180	280	74	2101.63
-	23036EKMW33	180	280	74	2101.63
-	23038EJW33	190	290	75	2509.67
-	23038EKJW33	190	290	75	2509.67
23038CAME4	-	190	290	75	2509.67
23038CAMKE4	-	190	290	75	2509.67
23040CAME4	23040EMW33	200	310	82	2687.09
23040CAMKE4	23040EKMW33	200	310	82	2687.09
23044CAME4	23044EMW33	220	340	90	3601.94

Spherical Roller Bearings  
 Pendelrollenlager  
 Roulements à rouleaux sphériques  
 Rodamientos de rodillos esféricos  
 Cuscinetti orientabili a due corone di rulli  
 Sfäriska rullager

NSK	RHP	d	D	B	€
23044CAMKE4	23044EKMW33	220	340	90	3601.94
23048CAME4	-	240	360	92	4023.57
23048CAMKE4	-	240	360	92	4363.20
23052CAME4	-	260	400	104	5475.82
23052CAMKE4	-	260	400	104	5475.82
23056CAME4	-	280	420	106	6756.19
23060CAME4	-	300	460	118	10048.80
23060CAMKE4	-	300	460	118	10048.80
23064CAME4	-	320	480	121	11537.96
23064CAMKE4	-	320	480	121	11537.96
23068CAME4	-	340	520	133	14782.62
23068CAMKE4	-	340	520	133	14358.22
23072CAME4	-	360	540	134	16808.45
23076CAME4	-	380	560	135	18052.77
23080CAMKE4	-	400	600	148	22937.58
23084CAME4	-	420	620	150	27535.52
-	23120EMW33	100	165	52	707.23
23122CE4	23122EJW33	110	180	56	811.04
23122CKE4	23122EKJW33	110	180	56	811.04
23124CE4	-	120	200	62	1080.72
23124CKE4	-	120	200	62	1080.72
23124CAME4	23124EMW33	120	200	62	1080.72
23124CAMKE4	23124EKMW33	120	200	62	1080.72
23126CE4	-	130	210	64	1235.69
23126CKE4	-	130	210	64	1235.69
23126CAME4	23126EMW33	130	210	64	1235.69
23126CAMKE4	23126EKMW33	130	210	64	1235.69
23128CE4	-	140	225	68	1444.65
23128CKE4	-	140	225	68	1444.65
23128CAME4	23128EMW33	140	225	68	1444.65
23128CAMKE4	23128EKMW33	140	225	68	1444.65
23130CE4	-	150	250	80	1871.82
23130CKE4	-	150	250	80	1871.82
23130CAME4	23130EMW33	150	250	80	1871.82
23130CAMKE4	23130EKMW33	150	250	80	1871.82
23132CE4	-	160	270	86	2178.54
23132CKE4	-	160	270	86	2178.54
23132CAME4	23132EMW33	160	270	86	2178.54
23132CAMKE4	23132EKMW33	160	270	86	2178.54
23134CE4	-	170	280	88	2561.32

Spherical Roller Bearings  
 Pendelrollenlager  
 Roulements à rouleaux sphériques  
 Rodamientos de rodillos esféricos  
 Cuscinetti orientabili a due corone di rulli  
 Sfäriska rullager

NSK	RHP	d	D	B	€
23134CKE4		170	280	88	2561.32
23134CAME4	23134EMW33	170	280	88	2561.32
-	23134EKMW33	170	280	88	2561.32
23136CE4	-	180	300	96	2902.32
23136CKE4	-	180	300	96	2902.32
23136CAME4	23136EMW33	180	300	96	2902.32
23136CAMKE4	23136EKMW33	180	300	96	2902.32
23138CE4	-	190	320	104	3693.67
23138CKE4	-	190	320	104	3693.67
23140CE4	-	200	340	112	3978.86
23140CKE4	-	200	340	112	3978.86
23144CE4	-	220	370	120	5172.54
23144CKE4	-	220	370	120	5172.54
23148CKE4	-	240	400	128	6969.45
23148CAME4	-	240	400	128	6969.45
23152CAME4	-	260	440	144	10906.61
23152CAMKE4	-	260	440	144	10906.61
23156CAMKE4	-	280	460	146	13514.55
23160CAME4	-	300	500	160	17548.26
23164CAMKE4	-	320	540	176	21934.44
23188CAMKE4	-	440	720	226	53065.45
23218CE4	23218EJW33	90	160	52.4	706.12
23218CKE4	23218EKJW33	90	160	52.4	706.12
23220CE4	23220EJW33	100	180	60.3	881.59
23220CKE4	23220EKJW33	100	180	60.3	881.59
23222CE4	-	110	200	69.8	1093.69
23222CKE4	-	110	200	69.8	1093.69
23222CAME4	23222EMW33	110	200	69.8	1093.69
23222CAMKE4	23222EKMW33	110	200	69.8	1093.69
23224CE4	-	120	215	76	1384.50
23224CKE4	-	120	215	76	1384.50
23224CAME4	23224EMW33	120	215	76	1384.50
23224CAMKE4	23224EKMW33	120	215	76	1384.50
23226CE4	-	130	230	80	1650.85
23226CKE4	-	130	230	80	1650.85
23226CAME4	23226EMW33	130	230	80	1650.85
23226CAMKE4	23226EKMW33	130	230	80	1650.85
23228CE4	-	140	250	88	2056.73
23228CKE4	-	140	250	88	2056.73
23228CAME4	23228EMW33	140	250	88	2056.73

Spherical Roller Bearings  
 Pendelrollenlager  
 Roulements à rouleaux sphériques  
 Rodamientos de rodillos esféricos  
 Cuscinetti orientabili a due corone di rulli  
 Sfäriska rullager

NSK	RHP	d	D	B	€
23228CAMKE4	23228EKMW33	140	250	88	2056.73
23230CE4	-	150	270	96	2665.59
23230CKE4	-	150	270	96	2665.59
23230CAME4	23230EMW33	150	270	96	2665.59
23230CAMKE4	23230EKMW33	150	270	96	2665.59
23232CE4	-	160	290	104	3164.83
23232CKE4	-	160	290	104	3164.83
23232CAME4	23232EMW33	160	290	104	3164.83
23232CAMKE4	23232EKMW33	160	290	104	3164.83
23234CE4	-	170	310	110	4030.74
23234CKE4	-	170	310	110	4030.74
23236CE4	-	180	320	112	4393.40
23236CKE4	-	180	320	112	4393.40
23238CE4	-	190	340	120	4957.17
23238CKE4	-	190	340	120	4957.17
23240CE4	-	200	360	128	6283.55
23240CKE4	-	200	360	128	6283.55
23244CE4	-	220	400	144	8374.53
23244CKE4	-	220	400	144	8374.53
23244CAME4	23244EMW33	220	400	144	8374.53
23244CAMKE4	23244EKMW33	220	400	144	8374.53
23248CAME4	-	240	440	160	13056.79
23252CAME4	-	260	480	174	18290.82
23252CAMKE4	-	260	480	174	18290.82
23256CAME4	-	280	500	176	21248.84
23260CAME4	-	300	540	192	27571.83
23264CAME4	-	320	580	208	33083.04
23936CAME4	-	180	250	52	2339.70
23940CAME4	-	200	280	60	2611.51
23952CAME4	-	260	360	75	4610.71
23956CAME4	-	280	380	75	4996.89
23960CAME4	-	300	420	90	6398.44
23964CAME4	-	320	440	90	9237.48
23968CAME4	-	340	460	90	11252.46
23976CAME4	-	380	520	106	15780.77
23980CAME4	-	400	540	106	19016.85
23984CAMKE4	-	420	560	106	19795.18
23988CAME4	-	440	600	118	26392.47
24024CE4	24024JW33	120	180	60	1101.08
24026CE4	24026JW33	130	200	69	1304.68



Spherical Roller Bearings  
 Pendelrollenlager  
 Roulements à rouleaux sphériques  
 Rodamientos de rodillos esféricos  
 Cuscinetti orientabili a due corone di rulli  
 Sfäriska rullager

NSK	RHP	d	D	B	€
24028CE4	24028JW33	140	210	69	1512.45
24030CE4	24030JW33	150	225	75	1729.98
24032CE4	-	160	240	80	2038.22
24034CE4	24034EJW33	170	260	90	2493.92
24036CE4	24036JW33	180	280	100	2828.27
24038CE4	24038EJW33	190	290	100	3185.07
24040CE4	24040EJW33	200	310	109	3760.13
24044CE4	-	220	340	118	4923.72
24048CAME4	-	240	360	118	5887.56
24056CAME4	-	280	420	140	9208.29
24064CAME4	-	320	480	160	18394.30
24084CAME4	-	420	620	200	44254.46
24122CE4	24122JW33	110	180	69	1248.45
24124CE4	24124JW33	120	200	80	1459.72
24126CE4	24126JW33	130	210	80	1832.18
24128CE4	24128JW33	140	225	85	2306.41
24130CE4	24130JW33	150	250	100	2614.12
24132CE4	24132JW33	160	270	109	3348.24
24134CE4	24134JW33	170	280	109	3621.23
24136CE4	24136JW33	180	300	118	4342.89
24138CE4	24138JW33	190	320	128	5415.15
24140CE4	-	200	340	140	6406.79
24148CE4	-	240	400	160	10055.23
24148CK30E4	-	240	400	160	11095.40
24148CAME4	-	240	400	160	10055.23
24152CAME4	-	260	440	180	17161.49
24156CAME4	-	280	460	180	19291.94
24156CAMK30E4	-	280	460	180	20676.48
24160CAME4	-	300	500	200	25471.66
24160CAMK30E4	-	300	500	200	24740.44
29232M	-	160	225	39	5155.44
29234M	-	170	240	42	5416.16
29240M	-	200	280	48	5022.36
29244M	-	220	300	48	6188.93
29248M	-	240	340	60	6791.83
29252M	-	260	360	60	8150.89
29256M	-	280	380	60	7817.08
29260M	-	300	420	73	11146.21
29264M	-	320	440	73	16034.73
29317E	-	85	150	39	1381.12

Spherical Roller Bearings  
 Pendelrollenlager  
 Roulements à rouleaux sphériques  
 Rodamientos de rodillos esféricos  
 Cuscinetti orientabili a due corone di rulli  
 Sfäriska rullager

NSK	RHP	d	D	B	€
29318E	-	90	155	39	1334.01
29320E	-	100	170	42	1395.14
29322E	-	110	190	48	1601.79
29324E	-	120	210	54	1755.99
29326E	-	130	225	58	1992.07
29328E	-	140	240	60	2537.75
29330E	-	150	250	60	2661.75
29332E	-	160	270	67	3069.55
29334E	-	170	280	67	3376.75
29336E	-	180	300	73	3893.22
29338E	-	190	320	78	4528.45
29340E	-	200	340	85	5251.76
29344M	-	220	360	85	6591.07
29348M	-	240	380	85	7694.55
29352M	-	260	420	95	9956.83
29356M	-	280	440	95	15094.52
29360M	-	300	480	109	18821.99
29412E	-	60	130	42	1019.61
29413E	-	65	140	45	1108.09
29414E	-	70	150	48	1231.17
29415E	-	75	160	51	1311.27
29416E	-	80	170	54	1464.93
29417E	-	85	180	58	1741.69
29418E	-	90	190	60	1672.87
29420E	-	100	210	67	2070.27
29422E	-	110	230	73	2376.24
29424E	-	120	250	78	2829.70
29426E	-	130	270	85	3247.31
29428E	-	140	280	85	3995.68
29430E	-	150	300	90	4279.51
29432E	-	160	320	95	4882.86
29434M	-	170	340	103	5836.79
29436M	-	180	360	109	7630.89
29438M	-	190	380	115	8156.00
29440M	-	200	400	122	9726.81
29444M	-	220	420	122	13956.10
29448M	-	240	440	122	21216.65
29452M	-	260	480	132	24836.62
29456M	-	280	520	145	28808.92
29460M	-	300	540	145	33869.69

**Tapered Roller Bearings - metric**

**Metrische Kegelrollenlager**

**Roulements à rouleaux coniques - métrique**

**Rodamientos de rodillos cónicos**

**Cuscinetti a rulli conici**

**Koniska rullager - metriska**

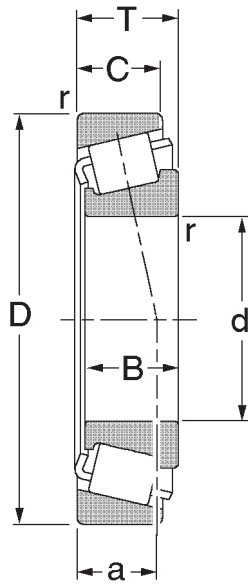

Tapered Roller Bearings - metric  
 Metrische Kegelrollenlager  
 Roulements à rouleaux coniques - métrique  
 Rodamientos de rodillos cónicos  
 Cuscinetti a rulli conici  
 Koniska rullager - metriská

NSK	RHP	d	D	B	€
30202	-	15	35	11.75	47.61
30203J	-	17	40	13.25	26.80
30204J	-	20	47	15.25	28.53
30205J	-	25	52	16.25	31.61
30206J	-	30	62	17.25	34.74
30207J	-	35	72	18.25	43.31
30208J	-	40	80	19.75	51.98
30209J	-	45	85	20.75	57.92
30210J	-	50	90	21.75	73.57
30211J	-	55	100	22.75	81.62
30212J	-	60	110	23.75	97.31
30213J	-	65	120	24.75	120.04
30214J	-	70	125	26.25	132.77
30215J	-	75	130	27.25	139.94
30216J	-	80	140	28.25	166.41
30217J	-	85	150	30.50	200.09
30218J	-	90	160	32.50	246.52
30219J	-	95	170	34.50	300.65
30220J	-	100	180	37.00	369.63
30221J	-	105	190	39.00	453.52
30222J	-	110	200	41	532.50
30224J	-	120	215	43.50	690.61
30226J	-	130	230	43.75	920.92
30228J	-	140	250	45.75	1264.97
30230	-	150	270	49	1700.51
30232	-	160	290	52	2143.18
30234	-	170	310	57	2989.05
30236	-	180	320	57	4609.82
30302J	-	15	42	14.25	33.62
30303J	-	17	47	15.25	33.13
30304J	-	20	52	16.25	32.81
30305J	-	25	62	18.25	39.84
30306J	-	30	72	20.75	49.22
30307J	-	35	80	22.75	58.57
30308J	-	40	90	25.25	72.12
30309J	-	45	100	27.25	91.72
30310J	-	50	110	29.25	111.65
30311J	-	55	120	31.50	146.66
30312J	-	60	130	33.50	175.07
30313J	-	65	140	36	219.92

Tapered Roller Bearings - metric  
 Metrische Kegelrollenlager  
 Roulements à rouleaux coniques - métrique  
 Rodamientos de rodillos cónicos  
 Cuscinetti a rulli conici  
 Koniska rullager - metriska

NSK	RHP	d	D	B	€
30314J	-	70	150	38	273.82
30315J	-	75	160	40	333.10
30316J	-	80	170	42.50	395.69
30317J	-	85	180	44.50	500.35
30318J	-	90	190	46.50	595.16
30319J	-	95	200	49.50	701.06
30320J	-	100	215	51.50	934.93
30322J	-	110	240	54.50	1529.25
31305J	-	25	62	18.25	64.11
31306J	-	30	72	20.75	73.21
31307J	-	35	80	22.75	86.06
31308J	-	40	90	25.25	103.41
31309J	-	45	100	27.25	135.90
31310J	-	50	110	29.25	155.63
31311J	-	55	120	31.50	186.63
31312J	-	60	130	33.50	229.31
31313J	-	65	140	36	319.45
31314J	-	70	150	38	343.83
31315J	-	75	160	40	465.29
31316J	-	80	170	42.50	542.17
31317J	-	85	180	44.50	758.67
31318J	-	90	190	46.50	917.10
31319J	-	95	200	49.50	1004.63
31320J	-	100	215	56.50	1962.23
31322J	-	110	240	63	2705.66
31324J	-	120	260	68	2883.66
31328J	-	140	300	77	4806.02
31330J	-	150	320	82	6736.26
32004XJ	-	20	42	15	33.65
320/22XJ	-	22	44	15	134.99
32005XJ	-	25	47	15	33.36
320/28XJ	-	28	52	16	45.33
32006XJ	-	30	55	17	38.29
32007XJ	-	35	62	18	43.19
32008XJ	-	40	68	19	47.30
32009XJ	-	45	75	20	54.19
32010XJ	-	50	80	20	64.58
32011XJ	-	55	90	23	76.32
32012XJ	-	60	95	23	92.90
32013XJ	-	65	100	23	108.92

Tapered Roller Bearings - metric  
 Metrische Kegelrollenlager  
 Roulements à rouleaux coniques - métrique  
 Rodamientos de rodillos cónicos  
 Cuscinetti a rulli conici  
 Koniska rullager - metriska

NSK	RHP	d	D	B	€
32015XJ	-	75	115	25	136.05
32016XJ	-	80	125	29	162.75
32017XJ	-	85	130	29	182.78
32018XJ	-	90	140	32	209.94
32019XJ	-	95	145	32	231.82
32020XJ	-	100	150	32	232.21
32021XJ	-	105	160	35	314.36
32022XJ	-	110	170	38	344.29
32024XJ	-	120	180	38	485.44
32026XJ	-	130	200	45	618.11
32028XJ	-	140	210	45	811.18
32030XJ	-	150	225	48	1056.90
32032XJ	-	160	240	51	1266.42
32034XJ	-	170	260	57	1696.36
32036XJ	-	180	280	64	1992.11
32038XJ	-	190	290	64	2580.93
32040XJ	-	200	310	70	3051.89
32044XJ	-	220	340	76	4311.26
32048XJ	-	240	360	76	5243.44
32204J	-	20	47	19.25	58.05
32205J	-	25	52	19.25	66.34
322/28	-	28	58	20.25	81.80
32206J	-	30	62	21.25	44.00
322/32	-	32	65	22.25	106.35
32207J	-	35	72	24.25	51.39
32208J	-	40	80	24.75	57.60
32209J	-	45	85	24.75	64.57
32210J	-	50	90	24.75	72.37
32211J	-	55	100	26.75	98.24
32212J	-	60	110	29.75	117.30
32213J	-	65	120	32.75	146.66
32214J	-	70	125	33.25	154.17
32215J	-	75	130	33.25	165.24
32216J	-	80	140	35.25	187.46
32217J	-	85	150	38.50	226.27
32218J	-	90	160	42.50	298.43
32219J	-	95	170	45.50	375.67
32220J	-	100	180	49	446.58
32221J	-	105	190	53	561.19
32222J	-	110	200	56	729.25

Tapered Roller Bearings - metric  
 Metrische Kegelrollenlager  
 Roulements à rouleaux coniques - métrique  
 Rodamientos de rodillos cónicos  
 Cuscinetti a rulli conici  
 Koniska rullager - metriska

NSK	RHP	d	D	B	€
32224J	-	120	215	61.50	1268.94
32226J	-	130	230	67.75	1640.55
32228J	-	140	250	71.75	2041.19
32230J	-	150	270	77	2658.09
32232J	-	160	290	84	3548.53
32234J	-	170	310	91	4218.05
32236J	-	180	320	91	4747.69
32303	-	17	47	20.25	57.28
32304J	-	20	52	22.25	51.20
32305J	-	25	62	25.25	55.40
32306J	-	30	72	28.75	69.77
32307J	-	35	80	32.75	80.81
32308J	-	40	90	35.25	98.08
32309J	-	45	100	38.25	117.84
32310J	-	50	110	42.25	146.94
32311J	-	55	120	45.50	187.12
32312J	-	60	130	48.50	227.88
32313J	-	65	140	51	304.54
32314J	-	70	150	54	358.95
32315J	-	75	160	58	449.87
32316J	-	80	170	61.50	539.95
32317J	-	85	180	63.50	729.16
32318J	-	90	190	67.50	941.13
32319J	-	95	200	71.50	1325.27
32320J	-	100	215	77.50	1684.53
32322J	-	110	240	84.50	2375.83
32324J	-	120	260	90.50	3135.56
32326	-	130	280	98.75	3824.98
32328	-	140	300	107.80	4589.67
32330	-	150	320	114	6453.16
32332	-	160	340	121	7696.81
32334	-	170	360	127	8755.80
32907J	-	35	55	14	273.50
32912J	-	60	85	17	349.48
32913J	-	65	90	17	367.27
32914J	-	70	100	20	254.18
32915J	-	75	105	20	390.11
32916J	-	80	110	20	410.39
32917J	-	85	120	23	425.30
32918J	-	90	125	23	445.96



Tapered Roller Bearings - metric  
 Metrische Kegelrollenlager  
 Roulements à rouleaux coniques - métrique  
 Rodamientos de rodillos cónicos  
 Cuscinetti a rulli conici  
 Koniska rullager - metriskä

NSK	RHP	d	D	B	€
32920J	-	100	140	25	476.64
32922J	-	110	150	25	507.26
32924J	-	120	165	29	441.00
32926J	-	130	180	32	611.77
32928J	-	140	190	32	686.38
32930	-	150	210	38	828.96
32932	-	160	220	38	1025.76
32934J	-	170	230	38	1059.30
32936J	-	180	250	45	1339.01
32938J	-	190	260	45	1580.83
32944J	-	220	300	51	3467.41
33005J	-	25	47	17	41.60
33007J	-	35	62	21	76.34
33010J	-	50	80	24	102.90
33011J	-	55	90	27	129.51
33012J	-	60	95	27	146.72
33013J	-	65	100	27	161.44
33014J	-	70	110	31	153.50
33015J	-	75	115	31	168.01
33021J	-	105	160	43	341.61
33022J	-	110	170	47	416.12
33024J	-	120	180	48	542.50
33109J	-	45	80	26	93.70
33110J	-	50	85	26	105.78
33111J	-	55	95	30	123.09
33113J	-	65	110	34	164.55
33115J	-	75	125	37	214.78
33116J	-	80	130	37	231.30
33117J	-	85	140	41	305.09
33118J	-	90	150	45	330.96
33205J	-	25	52	25	51.93
33206J	-	30	62	25	65.80
33207J	-	35	72	28	78.50
33208J	-	40	80	32	93.80
33209J	-	45	85	32	106.43
33210J	-	50	90	32	113.74
33211J	-	55	100	35	138.03
33212J	-	60	110	38	179.02
33213J	-	65	120	41	204.64
33214J	-	70	125	41	230.86

Tapered Roller Bearings - metric  
Metrische Kegelrollenlager  
Roulements à rouleaux coniques - métrique  
Rodamientos de rodillos cónicos  
Cuscinetti a rulli conici  
Koniska rullager - metriska

NSK	RHP	d	D	B	€
33215J	-	75	130	41	259.27
33216J	-	80	140	46	332.56
33217J	-	85	150	49	400.80
33220J	-	100	180	63	1022.53

**Tapered Roller Bearings - inch**

**Zöllige Kegelrollenlager**

**Roulements à rouleaux coniques - pouce**

**Rodamientos de rodillos cónicos serie pulgadas**

**Cuscinetti a rulli conici - dimensioni in pollici**

**Koniska rullager - tum**

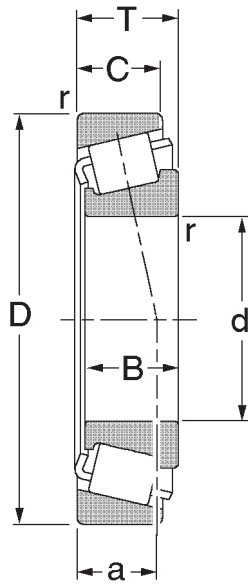

Tapered Roller Bearings - inch  
 Zöllige Kegelrollenlager  
 Roulements à rouleaux coniques - pouce  
 Rodamientos de rodillos cónicos serie pulgadas  
 Cuscinetti a rulli conici - dimensioni in pollici  
 Koniska rullager - tum

NSK	RHP	d	D	B	€
02474R/02420R	-	-	-	-	71.99
08125R/08231R	-	-	-	-	81.01
09067R/09195R	-	-	-	-	44.72
09081RG/09196RG	-	-	-	-	65.01
11590R/11520R	-	-	-	-	65.92
14138RG/14276RG	-	-	-	-	55.84
15101R/15245R	-	-	-	-	68.03
15123R/15245R	-	-	-	-	50.77
17887R/17831R	-	-	-	-	153.42
18590R/18520R	-	-	-	-	86.49
18690R/18620R	-	-	-	-	58.31
1988R/1922R	-	-	-	-	79.61
25580R/25520R	-	-	-	-	87.04
25580R/25522R	-	-	-	-	77.81
25590R/25520R	-	-	-	-	87.04
2580R/2523R	-	-	-	-	77.26
26882R/26822R	-	-	-	-	113.94
2780R/2720R	-	-	-	-	81.21
2788R/2720R	-	-	-	-	92.77
28580R/28521R	-	-	-	-	104.87
28584R/28521R	-	-	-	-	114.73
28680R/28622R	-	-	-	-	170.52
28682R/28622R	-	-	-	-	139.85
28985R/28920R	-	-	-	-	155.97
28985R/28921R	-	-	-	-	178.73
29586/29520	-	-	-	-	149.86
29590/29520	-	-	-	-	166.95
29590/29522	-	-	-	-	175.74
29675R/29620R	-	-	-	-	269.35
29685R/29620R	-	-	-	-	166.10
3578R/3525R	-	-	-	-	164.87
387ARG3/382ARG	-	-	-	-	84.64
39590R/39520R	-	-	-	-	137.20
3982R/3920R	-	-	-	-	233.20
3984R/3920R	-	-	-	-	153.76
418R/414R	-	-	-	-	110.13
462R/453R	-	-	-	-	124.80
497R/493R	-	-	-	-	157.12
580RG/572RG	-	-	-	-	286.32
594R/592AR	-	-	-	-	237.17

Tapered Roller Bearings - inch  
 Zöllige Kegelrollenlager  
 Roulements à rouleaux coniques - pouce  
 Rodamientos de rodillos cónicos serie pulgadas  
 Cuscinetti a rulli conici - dimensioni in pollici  
 Koniska rullager - tum

NSK	RHP	d	D	B	€
93825/93125	-	-	-	-	3145.29
938R/932R	-	-	-	-	1294.73
H414249RG/210RG	-	-	-	-	414.32
H913849G/810G	-	-	-	-	580.13
HM88649R/HM88610R	-	-	-	-	58.41
HM89449R/HM89410R	-	-	-	-	98.11
JHM522649RG/610RG	-	-	-	-	1503.25
JM515649RG3/610RG	-	-	-	-	298.99
L44643R/610R	-	-	-	-	28.27
L44649R/L44610R	-	-	-	-	25.71
L45449R/410R	-	-	-	-	25.73
L68149RGB3/110RGB	-	-	-	-	38.91
LM11949R/910R	-	-	-	-	23.10
LM11949R/LM11910R	-	-	-	-	23.10
LM29749R/LM29710R	-	-	-	-	40.29
LM300849R/811R	-	-	-	-	45.60
LM48548R/LM48510R	-	-	-	-	41.26
LM501349R/310R	-	-	-	-	54.81
LM603049RG/011RG	-	-	-	-	57.72
LM67048R/010R	-	-	-	-	30.88
M12649R/610R	-	-	-	-	39.19
M86649/610	-	-	-	-	49.38
M88048/010	-	-	-	-	56.00

**Super Precision Bearings**

**Hochgenauigkeitslager**

**Roulements de Précision**

**Rodamientos de Superprecisión**

**Cuscinetti di Super Precisione**

**Högprecisionslager**

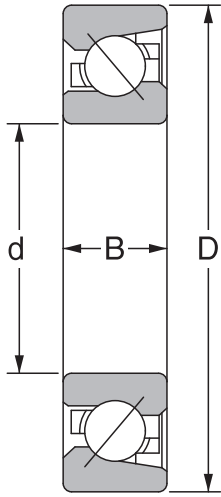

25°  
A5

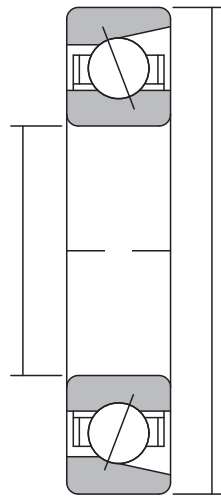

15°  
C



Super Precision Bearings  
Hochgenauigkeitslager  
Roulements de Précision  
Rodamientos de Superprecisión  
Cuscinetti di Super Precisione  
Högprecisionslager

NSK	RHP	d	D	B	€
6004TCG12P4	6004TCG12P4	20	42	12	219.48
6005TCG12P4	6005TCG12P4	25	47	12	249.21
6006TCG12P4	6006TCG12P4	30	55	13	256.16
6007TCG12P4	6007TCG12P4	35	62	14	298.71
6008TCG12P4	6008TCG12P4	40	68	15	307.05
6009TCG12P4	6009TCG12P4	45	75	16	365.17
6010TCG12P4	6010TCG12P4	50	80	16	398.18
6011TCG12P4	6011TCG12P4	55	90	18	423.90
6012TCG12P4	6012TCG12P4	60	95	18	483.39
6013TCG12P4	6013TCG12P4	65	100	18	556.47
6014TCG12P4	6014TCG12P4	70	110	20	634.71
6017TCG12P4	6017TCG12P4	85	130	22	1041.63
6018TCG12P4	6018TCG12P4	90	140	24	1254.67
6019TCG12P4	6019TCG12P4	95	145	24	1467.67
6020TCG12P4	6020TCG12P4	100	150	24	1738.96
6022TCG12P4	6022TCG12P4	110	170	28	2182.34
6204TCG12P4	6204TCG12P4	20	47	14	209.62
6205TCG12P4	6205TCG12P4	25	52	15	218.68
6206TCG12P4	6206TCG12P4	30	62	16	253.42
6207TCG12P4	6207TCG12P4	35	72	17	297.28
6208TCG12P4	6208TCG12P4	40	80	18	331.77
6209TCG12P4	6209TCG12P4	45	85	19	363.26
6210TCG12P4	6210TCG12P4	50	90	20	385.14
6211TCG12P4	6211TCG12P4	55	100	21	448.76
6212TCG12P4	6212TCG12P4	60	110	22	538.97
6213TCG12P4	6213TCG12P4	65	120	23	622.62
6214TCG12P4	6214TCG12P4	70	125	24	666.35
6215TCG12P4	6215TCG12P4	75	130	25	881.90
6216TCG12P4	6216TCG12P4	80	140	26	925.14
6217TCG12P4	6217TCG12P4	85	150	28	1080.29
-	6304TBR12P4	20	52	15	263.35
-	6305TBR12P4	25	62	17	285.73
-	6306TBR12P4	30	72	19	315.43
-	6307TBR12P4	35	80	21	358.47
-	6308TBR12P4	40	90	23	431.19
-	6309TBR12P4	45	100	25	514.78
-	6310TBR12P4	50	110	27	619.09
-	6311TBR12P4	55	120	29	732.52
-	6312TBR12P4	60	130	31	879.81
-	6313TBR12P4	65	140	33	1071.62

Super Precision Bearings  
Hochgenauigkeitslager  
Roulements de Précision  
Rodamientos de Superprecisión  
Cuscinetti di Super Precisione  
Högprecisionslager

NSK	RHP	d	D	B	€
-	6314TBR12P4	70	150	35	1257.48
-	6315TBR12P4	75	160	37	1457.33
-	6316TBR12P4	80	170	39	1689.64
-	6317TBR12P4	85	180	41	2113.84
7000CTRDULP3	7000CTRDULP3	10	26	16	442.85
7000CTRDUMP3	7000CTRDUMP3	10	26	16	456.15
7000A5TRDULP3	7000A5TRDULP3	10	26	16	442.85
7000A5TRDUMP3	7000A5TRDUMP3	10	26	16	456.15
7001CTRDULP3	7001CTRDULP3	12	28	8	458.54
7001CTRDUMP3	7001CTRDUMP3	12	28	8	472.31
7001A5TRDULP3	7001A5TRDULP3	12	28	8	458.54
7001A5TRDUMP3	7001A5TRDUMP3	12	28	8	472.31
7002CTRDULP3	7002CTRDULP3	15	32	18	470.30
7002CTRDUMP3	7002CTRDUMP3	15	32	18	484.40
7002A5TRDULP3	7002A5TRDULP3	15	32	18	470.30
7002A5TRDUMP3	7002A5TRDUMP3	15	32	18	484.40
7003CTRDULP3	7003CTRDULP3	17	35	20	489.89
7003CTRDUMP3	7003CTRDUMP3	17	35	20	504.58
7003A5TRDULP3	7003A5TRDULP3	17	35	20	489.89
7003A5TRDUMP3	7003A5TRDUMP3	17	35	20	504.58
7004CTRDULP3	7004CTRDULP3	20	42	24	505.54
7004CTRDUMP3	7004CTRDUMP3	20	42	24	520.73
7004A5TRDULP3	7004A5TRDULP3	20	42	24	505.54
7004A5TRDUMP3	7004A5TRDUMP3	20	42	24	520.73
7005CTRDULP3	7005CTRDULP3	25	47	24	505.54
7005CTRDUMP3	7005CTRDUMP3	25	47	24	520.73
7005A5TRDULP3	7005A5TRDULP3	25	47	24	505.54
7005A5TRDUMP3	7005A5TRDUMP3	25	47	24	520.73
7006CTRDULP3	7006CTRDULP3	30	55	26	525.15
7006CTRDUMP3	7006CTRDUMP3	30	55	26	540.91
7006CTRV1VSULP3	-	30	55	13	341.36
7006CTRV1VSUMP3	-	30	55	13	351.59
7006A5TRDULP3	7006A5TRDULP3	30	55	26	525.15
7006A5TRDUMP3	7006A5TRDUMP3	30	55	26	540.91
7006A5TRV1VSULP3	-	30	55	13	341.36
7006A5TRV1VSUMP3	-	30	55	13	351.59
7007CTRDULP3	7007CTRDULP3	35	62	28	595.71
7007CTRDUMP3	7007CTRDUMP3	35	62	28	613.58
7007CTRV1VSULP3	-	35	62	14	387.19
7007CTRV1VSUMP3	-	35	62	14	398.86

Super Precision Bearings  
Hochgenauigkeitslager  
Roulements de Précision  
Rodamientos de Superprecisión  
Cuscinetti di Super Precisione  
Högprecisionslager

NSK	RHP	d	D	B	€
7007A5TRDULP3	7007A5TRDULP3	35	62	28	595.71
7007A5TRDUMP3	7007A5TRDUMP3	35	62	28	613.58
7007A5TRV1VSULP3	-	35	62	14	387.19
7007A5TRV1VSUMP3	-	35	62	14	398.86
7008CTRULP3	7008CTRULP3	40	68	30	740.73
7008CTRDUMP3	7008CTRDUMP3	40	68	30	762.94
7008CTRV1VSULP3	-	40	68	15	481.45
7008CTRV1VSUMP3	-	40	68	15	495.90
7008A5TRDULP3	7008A5TRDULP3	40	68	30	740.73
7008A5TRDUMP3	7008A5TRDUMP3	40	68	30	762.94
7008A5TRV1VSULP3	-	40	68	15	481.45
7008A5TRV1VSUMP3	-	40	68	15	495.90
7009CTRDULP3	7009CTRDULP3	45	75	32	811.29
7009CTRDUMP3	7009CTRDUMP3	45	75	32	835.59
7009CTRV1VSULP3	-	45	75	16	527.32
7009CTRV1VSUMP3	-	45	75	16	543.15
7009A5TRDULP3	7009A5TRDULP3	45	75	32	811.29
7009A5TRDUMP3	7009A5TRDUMP3	45	75	32	835.59
7009A5TRV1VSULP3	-	45	75	16	527.32
7009A5TRV1VSUMP3	-	45	75	16	543.15
7010CTRDULP3	7010CTRDULP3	50	80	32	838.67
7010CTRDUMP3	7010CTRDUMP3	50	80	32	863.84
7010CTRV1VSULP3	-	50	80	16	545.15
7010CTRV1VSUMP3	-	50	80	16	561.52
7010A5TRDULP3	7010A5TRDULP3	50	80	32	838.67
7010A5TRDUMP3	7010A5TRDUMP3	50	80	32	863.84
7010A5TRV1VSULP3	-	50	80	16	545.15
7010A5TRV1VSUMP3	-	50	80	16	561.52
7011CTRDULP3	7011CTRDULP3	55	90	36	983.70
7011CTRDUMP3	7011CTRDUMP3	55	90	36	1013.19
7011CTRV1VSULP3	-	55	90	18	639.40
7011CTRV1VSUMP3	-	55	90	18	658.59
7011A5TRDULP3	7011A5TRDULP3	55	90	36	983.70
7011A5TRDUMP3	7011A5TRDUMP3	55	90	36	1013.19
7011A5TRV1VSULP3	-	55	90	18	639.40
7011A5TRV1VSUMP3	-	55	90	18	658.59
7012CTRDULP3	7012CTRDULP3	60	95	36	1081.70
7012CTRDUMP3	7012CTRDUMP3	60	95	36	1114.13
7012CTRV1VSULP3	-	60	95	18	703.07
7012CTRV1VSUMP3	-	60	95	18	724.19

Super Precision Bearings  
Hochgenauigkeitslager  
Roulements de Précision  
Rodamientos de Superprecisión  
Cuscinetti di Super Precisione  
Högprecisionslager

NSK	RHP	d	D	B	€
7012A5TRDULP3	7012A5TRDULP3	60	95	36	1081.70
7012A5TRDUMP3	7012A5TRDUMP3	60	95	36	1114.13
7012A5TRV1VSULP3	-	60	95	18	703.07
7012A5TRV1VSUMP3	-	60	95	18	724.19
7013CTRULP3	7013CTRULP3	65	100	36	1179.64
7013CTRUMP3	7013CTRUMP3	65	100	36	1215.04
7013CTRV1VSULP3	-	65	100	18	766.78
7013CTRV1VSUMP3	-	65	100	18	789.78
7013A5TRDULP3	7013A5TRDULP3	65	100	36	1179.64
7013A5TRDUMP3	7013A5TRDUMP3	65	100	36	1215.04
7013A5TRV1VSULP3	-	65	100	18	766.78
7013A5TRV1VSUMP3	-	65	100	18	789.78
7014CTRULP3	7014CTRULP3	70	110	40	1395.22
7014CTRUMP3	7014CTRUMP3	70	110	40	1437.06
7014CTRV1VSULP3	-	70	110	20	906.85
7014CTRV1VSUMP3	-	70	110	20	934.10
7014A5TRDULP3	7014A5TRDULP3	70	110	40	1395.22
7014A5TRDUMP3	7014A5TRDUMP3	70	110	40	1437.06
7014A5TRV1VSULP3	-	70	110	20	906.85
7014A5TRV1VSUMP3	-	70	110	20	934.10
7015CTRULP3	7015CTRULP3	75	115	40	1469.66
7015CTRUMP3	7015CTRUMP3	75	115	40	1513.73
7015CTRV1VSULP3	-	75	115	20	955.29
7015CTRV1VSUMP3	-	75	115	20	983.96
7015A5TRDULP3	7015A5TRDULP3	75	115	40	1469.66
7015A5TRDUMP3	7015A5TRDUMP3	75	115	40	1513.73
7015A5TRV1VSULP3	-	75	115	20	955.29
7015A5TRV1VSUMP3	-	75	115	20	983.96
7016CTRULP3	7016CTRULP3	80	125	44	1595.09
7016CTRUMP3	7016CTRUMP3	80	125	44	1642.94
7016CTRV1VSULP3	-	80	125	22	1036.80
7016CTRV1VSUMP3	-	80	125	22	1067.91
7016A5TRDULP3	7016A5TRDULP3	80	125	44	1595.09
7016A5TRDUMP3	7016A5TRDUMP3	80	125	44	1642.94
7016A5TRV1VSULP3	-	80	125	22	1036.80
7016A5TRV1VSUMP3	-	80	125	22	1067.91
7017CTRULP3	7017CTRULP3	85	130	44	1759.70
7017CTRUMP3	7017CTRUMP3	85	130	44	1812.48
7017CTRV1VSULP3	-	85	130	22	1143.81
7017CTRV1VSUMP3	-	85	130	22	1178.12

Super Precision Bearings  
Hochgenauigkeitslager  
Roulements de Précision  
Rodamientos de Superprecisión  
Cuscinetti di Super Precisione  
Högprecisionslager

NSK	RHP	d	D	B	€
7017A5TRDULP3	7017A5TRDULP3	85	130	44	1759.70
7017A5TRDUMP3	7017A5TRDUMP3	85	130	44	1812.48
7017A5TRV1VSULP3	-	85	130	22	1143.81
7017A5TRV1VSUMP3	-	85	130	22	1178.12
7018CTRULP3	7018CTRULP3	90	140	48	2084.96
7018CTRDUMP3	7018CTRDUMP3	90	140	48	2147.50
7018CTRV1VSUEL3	-	90	140	24	1355.25
7018A5TRDULP3	7018A5TRDULP3	90	140	48	2084.96
7018A5TRDUMP3	7018A5TRDUMP3	90	140	48	2147.50
7018A5TRV1VSULP3	-	90	140	24	1355.25
7019CTRULP3	7019CTRULP3	95	145	48	2343.62
7019CTRDUMP3	7019CTRDUMP3	95	145	48	2411.21
7019A5TRDULP3	7019A5TRDULP3	95	145	48	2343.62
7019A5TRDUMP3	7019A5TRDUMP3	95	145	48	2411.21
7020CTRULP3	7020CTRULP3	100	150	48	2339.73
7020CTRDUMP3	7020CTRDUMP3	100	150	48	2409.90
7020CTRV1VSULP3	-	100	150	24	1520.81
7020CTRV1VSUMP3	-	100	150	24	1566.43
7020A5TRDULP3	7020A5TRDULP3	100	150	48	2339.73
7020A5TRDUMP3	7020A5TRDUMP3	100	150	48	2409.90
7020A5TRV1VSULP3	-	100	150	24	1520.81
7020A5TRV1VSUMP3	-	100	150	24	1566.43
7021CTRULP3	7021CTRULP3	105	160	52	2694.15
7021CTRDUMP3	7021CTRDUMP3	105	160	52	2771.88
7021CTRV1VSULP3	-	105	160	26	1751.21
7021A5TRDULP3	7021A5TRDULP3	105	160	52	2694.15
7021A5TRDUMP3	7021A5TRDUMP3	105	160	52	2771.88
7022CTRULP3	7022CTRULP3	110	170	56	2774.74
7022CTRDUMP3	7022CTRDUMP3	110	170	56	2858.00
7022A5TRDULP3	7022A5TRDULP3	110	170	56	2774.74
7022A5TRDUMP3	7022A5TRDUMP3	110	170	56	2858.00
7024CTRULP3	7024CTRULP3	120	180	56	3111.75
7024CTRDUMP3	7024CTRDUMP3	120	180	56	3205.10
7024A5TRDULP3	7024A5TRDULP3	120	180	56	3111.75
7024A5TRDUMP3	7024A5TRDUMP3	120	180	56	3205.10
7026CTRULP3	7026CTRULP3	130	200	66	3770.17
7026A5TRDULP3	7026A5TRDULP3	130	200	66	3770.17
7026A5TRDUMP3	7026A5TRDUMP3	130	200	66	3883.29
7028CTRULP3	7028CTRULP3	140	210	66	4244.38
7028CTRDUMP3	7028CTRDUMP3	140	210	66	4371.72

Super Precision Bearings  
Hochgenauigkeitslager  
Roulements de Précision  
Rodamientos de Superprecisión  
Cuscinetti di Super Precisione  
Högprecisionslager

NSK	RHP	d	D	B	€
7028A5TRDUMP3	7028A5TRDUMP3	140	210	66	4371.72
7030CTR DUMP3	7030CTR DUMP3	150	225	70	5223.44
7030A5TRDULP3	7030A5TRDULP3	150	225	70	5071.32
7032A5TRDUMP3	7032A5TRDUMP3	160	240	76	6648.39
7034CTR DUMP3	7034CTR DUMP3	170	260	84	7754.44
7036A5TRDUMP3	7036A5TRDUMP3	180	280	92	9732.42
-	7038A5TRDUMP3	190	290	92	12574.23
7040A5TRDUMP3	7040A5TRDUMP3	200	310	102	16348.54
7200CTR DULP3	7200CTR DULP3	10	30	18	474.23
7200CTR DUMP3	7200CTR DUMP3	10	30	18	488.44
7200A5TRDULP3	7200A5TRDULP3	10	30	18	474.23
7200A5TRDUMP3	7200A5TRDUMP3	10	30	18	488.44
7201CTR DULP3	7201CTR DULP3	12	32	20	478.16
7201CTR DUMP3	7201CTR DUMP3	12	32	20	492.49
7201A5TRDULP3	7201A5TRDULP3	12	32	20	478.16
7201A5TRDUMP3	7201A5TRDUMP3	12	32	20	492.49
7202CTR DULP3	7202CTR DULP3	15	35	22	485.95
7202CTR DUMP3	7202CTR DUMP3	15	35	22	500.56
7202A5TRDULP3	7202A5TRDULP3	15	35	22	485.95
7202A5TRDUMP3	7202A5TRDUMP3	15	35	22	500.56
7203CTR DULP3	7203CTR DULP3	17	40	24	556.54
7203CTR DUMP3	7203CTR DUMP3	17	40	24	573.23
7203A5TRDULP3	7203A5TRDULP3	17	40	24	556.54
7203A5TRDUMP3	7203A5TRDUMP3	17	40	24	573.23
7204CTR DULP3	7204CTR DULP3	20	47	28	556.54
7204CTR DUMP3	7204CTR DUMP3	20	47	28	573.23
7204A5TRDULP3	7204A5TRDULP3	20	47	28	556.54
7204A5TRDUMP3	7204A5TRDUMP3	20	47	28	573.23
7205CTR DULP3	7205CTR DULP3	25	52	30	572.17
7205CTR DUMP3	7205CTR DUMP3	25	52	30	589.37
7205A5TRDULP3	7205A5TRDULP3	25	52	30	572.17
7205A5TRDUMP3	7205A5TRDUMP3	25	52	30	589.37
7206CTR DULP3	7206CTR DULP3	30	62	32	631.00
7206CTR DUMP3	7206CTR DUMP3	30	62	32	649.92
7206A5TRDULP3	7206A5TRDULP3	30	62	32	631.00
7206A5TRDUMP3	7206A5TRDUMP3	30	62	32	649.92
7207CTR DULP3	7207CTR DULP3	35	72	34	717.17
7207CTR DUMP3	7207CTR DUMP3	35	72	34	738.71
7207A5TRDULP3	7207A5TRDULP3	35	72	34	717.17
7207A5TRDUMP3	7207A5TRDUMP3	35	72	34	738.71

Super Precision Bearings  
Hochgenauigkeitslager  
Roulements de Précision  
Rodamientos de Superprecisión  
Cuscinetti di Super Precisione  
Högprecisionslager

NSK	RHP	d	D	B	€
7208CTRULP3	7208CTRDULP3	40	80	36	917.06
7208CTRDUMP3	7208CTRDUMP3	40	80	36	944.58
7208A5TRDULP3	7208A5TRDULP3	40	80	36	917.06
7208A5TRDUMP3	7208A5TRDUMP3	40	80	36	944.58
7209CTRULP3	7209CTRDULP3	45	85	38	1007.24
7209CTRDUMP3	7209CTRDUMP3	45	85	38	1037.45
7209A5TRDULP3	7209A5TRDULP3	45	85	38	1007.24
7209A5TRDUMP3	7209A5TRDUMP3	45	85	38	1037.45
7210CTRULP3	7210CTRDULP3	50	90	40	1081.70
7210CTRDUMP3	7210CTRDUMP3	50	90	40	1114.13
7210A5TRDULP3	7210A5TRDULP3	50	90	40	1081.70
7210A5TRDUMP3	7210A5TRDUMP3	50	90	40	1114.13
7211CTRULP3	7211CTRDULP3	55	100	42	1199.23
7211CTRDUMP3	7211CTRDUMP3	55	100	42	1235.22
7211A5TRDULP3	7211A5TRDULP3	55	100	42	1199.23
7211A5TRDUMP3	7211A5TRDUMP3	55	100	42	1235.22
7212CTRULP3	7212CTRDULP3	60	110	44	1363.85
7212CTRDUMP3	7212CTRDUMP3	60	110	44	1404.75
7212A5TRDULP3	7212A5TRDULP3	60	110	44	1363.85
7212A5TRDUMP3	7212A5TRDUMP3	60	110	44	1404.75
7213CTRULP3	7213CTRDULP3	65	120	46	1551.97
7213CTRDUMP3	7213CTRDUMP3	65	120	46	1598.53
7213A5TRDULP3	7213A5TRDULP3	65	120	46	1551.97
7213A5TRDUMP3	7213A5TRDUMP3	65	120	46	1598.53
7214CTRULP3	7214CTRDULP3	70	125	48	1740.09
7214CTRDUMP3	7214CTRDUMP3	70	125	48	1792.28
7214A5TRDULP3	7214A5TRDULP3	70	125	48	1740.09
7214A5TRDUMP3	7214A5TRDUMP3	70	125	48	1792.28
7215CTRULP3	7215CTRDULP3	75	130	50	1841.96
7215CTRDUMP3	7215CTRDUMP3	75	130	50	1897.19
7215A5TRDULP3	7215A5TRDULP3	75	130	50	1841.96
7215A5TRDUMP3	7215A5TRDUMP3	75	130	50	1897.19
7216CTRULP3	7216CTRDULP3	80	140	52	1998.75
7216CTRDUMP3	7216CTRDUMP3	80	140	52	2058.69
7216A5TRDULP3	7216A5TRDULP3	80	140	52	1998.75
7216A5TRDUMP3	7216A5TRDUMP3	80	140	52	2058.69
7217CTRULP3	7217CTRDULP3	85	150	56	2269.18
7217CTRDUMP3	7217CTRDUMP3	85	150	56	2337.25
7217A5TRDULP3	7217A5TRDULP3	85	150	56	2269.18
7217A5TRDUMP3	7217A5TRDUMP3	85	150	56	2337.25

Super Precision Bearings  
Hochgenauigkeitslager  
Roulements de Précision  
Rodamientos de Superprecisión  
Cuscinetti di Super Precisione  
Högprecisionslager

NSK	RHP	d	D	B	€
7218CTRDULP3	7218CTRDULP3	90	160	60	2567.04
7218A5TRDULP3	7218A5TRDULP3	90	160	60	2567.04
7218A5TRDUMP3	7218A5TRDUMP3	90	160	60	2644.04
7219CTRDULP3	7219CTRDULP3	95	170	64	3056.92
-	7219A5TRDULP3	95	170	64	3056.92
7219A5TRDUMP3	7219A5TRDUMP3	95	170	64	3145.10
7220CTRDULP3	7220CTRDULP3	100	180	64	3346.90
7220CTRDUMP3	7220CTRDUMP3	100	180	64	3447.31
7220A5TRDULP3	7220A5TRDULP3	100	180	64	3346.90
-	7221CTRDULP3	105	190	72	3994.36
7224CTRDULP3	7224CTRDULP3	120	215	80	5094.88
7224A5TRDULP3	7224A5TRDULP3	120	215	80	5094.88
-	7303CTDULP4	17	47	28	1035.88
-	7303ETDULP4	17	47	28	1035.88
-	7303ETDUMP4	17	47	28	1065.75
7304CTDULP4	7304CTDULP4	20	52	30	1049.87
-	7304CTDUMP4	20	52	30	1080.15
-	7304ETDULP4	20	52	30	1049.87
-	7304ETDUMP4	20	52	30	1080.15
7305CTDULP4	7305CTDULP4	25	62	34	1069.36
-	7305CTDUMP4	25	62	34	1100.20
-	7305ETDULP4	25	62	34	1069.36
-	7305ETDUMP4	25	62	34	1100.20
-	7306CTDULP4	30	72	38	1147.34
-	7306CTDUMP4	30	72	38	1180.44
-	7306ETDULP4	30	72	38	1147.34
-	7306ETDUMP4	30	72	38	1180.44
7307CTDULP4	7307CTDULP4	35	80	42	1289.37
-	7307CTDUMP4	35	80	42	1326.56
-	7307ETDULP4	35	80	42	1289.37
-	7307ETDUMP4	35	80	42	1326.56
7308CTDULP4	7308CTDULP4	40	90	46	1333.91
-	7308CTDUMP4	40	90	46	1372.38
-	7308ETDULP4	40	90	46	1333.91
-	7308ETDUMP4	40	90	46	1372.38
-	7309CTDULP4	45	100	50	1503.75
-	7310CTDULP4	50	110	54	1709.85
-	7310ETDULP4	50	110	54	1709.85
-	7311CTDULP4	55	120	58	2108.14
-	7311CTDUMP4	55	120	58	2168.95



Super Precision Bearings  
Hochgenauigkeitslager  
Roulements de Précision  
Rodamientos de Superprecisión  
Cuscinetti di Super Precisione  
Högprecisionslager

NSK	RHP	d	D	B	€
-	7312CTDULP4	60	130	62	2291.93
-	7312CTDUMP4	60	130	62	2358.01
-	7312ETDULP4	60	130	62	2291.93
-	7313CTDULP4	65	140	66	3021.57
-	7313ETDULP4	65	140	66	3021.57
-	7314CTDULP4	70	150	70	3325.09
-	7314ETDULP4	70	150	70	3325.09
7903CTRULP3	7903CTRDULP3	17	30	14	489.89
7903CTRDUMP3	7903CTRDUMP3	17	30	14	504.58
7903A5TRDULP3	7903A5TRDULP3	17	30	14	489.89
7903A5TRDUMP3	7903A5TRDUMP3	17	30	14	504.58
7904CTRDULP3	7904CTRDULP3	20	37	18	493.82
7904CTRDUMP3	7904CTRDUMP3	20	37	18	508.64
7904A5TRDULP3	7904A5TRDULP3	20	37	18	493.82
7904A5TRDUMP3	7904A5TRDUMP3	20	37	18	508.64
7905CTRDULP3	7905CTRDULP3	25	42	18	517.32
7905CTRDUMP3	7905CTRDUMP3	25	42	18	532.86
7905A5TRDULP3	7905A5TRDULP3	25	42	18	517.32
7905A5TRDUMP3	7905A5TRDUMP3	25	42	18	532.86
7906CTRDULP3	7906CTRDULP3	30	47	18	548.68
7906CTRDUMP3	7906CTRDUMP3	30	47	18	565.14
7906CTRV1VSULP3	-	30	47	9	356.65
7906CTRV1VSUMP3	-	30	47	9	367.34
7906A5TRDULP3	7906A5TRDULP3	30	47	18	548.68
7906A5TRDUMP3	7906A5TRDUMP3	30	47	18	565.14
7906A5TRV1VSULP3	-	30	47	9	356.65
7906A5TRV1VSUMP3	-	30	47	9	367.34
7907CTRDULP3	7907CTRDULP3	35	55	20	599.61
7907CTRDUMP3	7907CTRDUMP3	35	55	20	617.61
7907CTRV1VSULP3	-	35	55	10	389.76
7907CTRV1VSUMP3	-	35	55	10	401.46
7907A5TRDULP3	7907A5TRDULP3	35	55	20	599.61
7907A5TRDUMP3	7907A5TRDUMP3	35	55	20	617.61
7907A5TRV1VSULP3	-	35	55	10	389.76
7907A5TRV1VSUMP3	-	35	55	10	401.46
7908CTRDULP3	7908CTRDULP3	40	62	24	709.34
7908CTRDUMP3	7908CTRDUMP3	40	62	24	730.62
7908CTRV1VSULP3	-	40	62	12	461.10
7908CTRV1VSUMP3	-	40	62	12	474.93
7908A5TRDULP3	7908A5TRDULP3	40	62	24	709.34

Super Precision Bearings  
Hochgenauigkeitslager  
Roulements de Précision  
Rodamientos de Superprecisión  
Cuscinetti di Super Precisione  
Högprecisionslager

NSK	RHP	d	D	B	€
7908A5TRDUMP3	7908A5TRDUMP3	40	62	24	730.62
7908A5TRV1VSULP3	-	40	62	12	461.10
7908A5TRV1VSUMP3	-	40	62	12	474.93
7909CTRULD3	7909CTRULD3	45	68	24	760.33
7909CTRULD3	7909CTRULD3	45	68	24	783.11
7909CTR1VSULP3	-	45	68	12	494.21
7909CTR1VSUMP3	-	45	68	12	509.04
7909A5TRDULP3	7909A5TRDULP3	45	68	24	760.33
7909A5TRDUMP3	7909A5TRDUMP3	45	68	24	783.11
7909A5TRV1VSULP3	-	45	68	12	494.21
7909A5TRV1VSUMP3	-	45	68	12	509.04
7910CTRULD3	7910CTRULD3	50	72	24	787.73
7910CTRULD3	7910CTRULD3	50	72	24	811.38
7910CTR1VSULP3	-	50	72	12	512.03
7910CTR1VSUMP3	-	50	72	12	527.43
7910A5TRDULP3	7910A5TRDULP3	50	72	24	787.73
7910A5TRDUMP3	7910A5TRDUMP3	50	72	24	811.38
7910A5TRV1VSULP3	-	50	72	12	512.03
7910A5TRV1VSUMP3	-	50	72	12	527.43
7911CTRULD3	7911CTRULD3	55	80	26	924.91
7911CTRULD3	7911CTRULD3	55	80	26	952.69
7911CTR1VSULP3	-	55	80	13	601.17
7911CTR1VSUMP3	-	55	80	13	619.24
7911A5TRDULP3	7911A5TRDULP3	55	80	26	924.91
7911A5TRDUMP3	7911A5TRDUMP3	55	80	26	952.69
7911A5TRV1VSULP3	-	55	80	13	601.17
7911A5TRV1VSUMP3	-	55	80	13	619.24
7912CTRULD3	7912CTRULD3	60	85	26	1015.05
7912CTRULD3	7912CTRULD3	60	85	26	1045.49
7912CTR1VSULP3	-	60	85	13	659.82
7912CTR1VSUMP3	-	60	85	13	679.60
7912A5TRDULP3	7912A5TRDULP3	60	85	26	1015.05
7912A5TRDUMP3	7912A5TRDUMP3	60	85	26	1045.49
7912A5TRV1VSULP3	-	60	85	13	659.82
7912A5TRV1VSUMP3	-	60	85	13	679.60
7913CTRULD3	7913CTRULD3	65	90	26	1105.19
7913CTRULD3	7913CTRULD3	65	90	26	1138.35
7913CTR1VSULP3	-	65	90	13	718.39
7913CTR1VSUMP3	-	65	90	13	739.95
7913A5TRDULP3	7913A5TRDULP3	65	90	26	1105.19

Super Precision Bearings  
Hochgenauigkeitslager  
Roulements de Précision  
Rodamientos de Superprecisión  
Cuscinetti di Super Precisione  
Högprecisionslager

NSK	RHP	d	D	B	€
7913A5TRDUMP3	7913A5TRDUMP3	65	90	26	1138.35
7913A5TRV1VSULP3	-	65	90	13	718.39
7913A5TRV1VSUMP3	-	65	90	13	739.95
7914CTRULP3	7914CTRULP3	70	100	32	1312.88
7914CTRDUMP3	7914CTRDUMP3	70	100	32	1352.27
7914CTRV1VSULP3	-	70	100	16	853.40
7914CTRV1VSUMP3	-	70	100	16	879.00
7914A5TRDULP3	7914A5TRDULP3	70	100	32	1312.88
7914A5TRDUMP3	7914A5TRDUMP3	70	100	32	1352.27
7914A5TRV1VSULP3	-	70	100	16	853.40
7914A5TRV1VSUMP3	-	70	100	16	879.00
7915CTRDULP3	7915CTRDULP3	75	105	32	1379.52
7915CTRDUMP3	7915CTRDUMP3	75	105	32	1420.93
7915CTRV1VSULP3	-	75	105	16	896.68
7915A5TRDULP3	7915A5TRDULP3	75	105	32	1379.52
7915A5TRDUMP3	7915A5TRDUMP3	75	105	32	1420.93
7915A5TRV1VSULP3	-	75	105	16	896.68
7916CTRDULP3	7916CTRDULP3	80	110	32	1489.26
7916CTRDUMP3	7916CTRDUMP3	80	110	32	1533.93
7916CTRV1VSULP3	-	80	110	16	968.03
7916CTRV1VSUMP3	-	80	110	16	997.07
7916A5TRDULP3	7916A5TRDULP3	80	110	32	1489.26
7916A5TRDUMP3	7916A5TRDUMP3	80	110	32	1533.93
7916A5TRV1VSULP3	-	80	110	16	968.03
7916A5TRV1VSUMP3	-	80	110	16	997.07
7917CTRDULP3	7917CTRDULP3	85	120	36	1559.78
7917CTRDUMP3	7917CTRDUMP3	85	120	36	1606.57
7917CTRV1VSULP3	-	85	120	18	1013.88
7917CTRV1VSUMP3	-	85	120	18	1044.31
7917A5TRDULP3	7917A5TRDULP3	85	120	36	1559.78
7917A5TRDUMP3	7917A5TRDUMP3	85	120	36	1606.57
7917A5TRV1VSULP3	-	85	120	18	1013.88
7917A5TRV1VSUMP3	-	85	120	18	1044.31
7918CTRDULP3	7918CTRDULP3	90	125	36	1865.48
7918CTRDUMP3	7918CTRDUMP3	90	125	36	1921.48
7918CTRV1VSULP3	-	90	125	18	1212.56
7918CTRV1VSUMP3	-	90	125	18	1248.92
7918A5TRDULP3	7918A5TRDULP3	90	125	36	1865.48
7918A5TRDUMP3	7918A5TRDUMP3	90	125	36	1921.48
7918A5TRV1VSULP3	-	90	125	18	1212.56

Super Precision Bearings  
Hochgenauigkeitslager  
Roulements de Précision  
Rodamientos de Superprecisión  
Cuscinetti di Super Precisione  
Högprecisionslager

NSK	RHP	d	D	B	€
7918A5TRV1VSUMP3	-	90	125	18	1248.92
7919CTRDULP3	7919CTRDULP3	95	130	36	2078.71
7919CTRDUMP3	7919CTRDUMP3	95	130	36	2138.67
7919CTRV1VSULP3	-	95	130	18	1351.17
7919CTRV1VSUMP3	-	95	130	18	1390.14
7919A5TRDULP3	7919A5TRDULP3	95	130	36	2078.71
7919A5TRDUMP3	7919A5TRDUMP3	95	130	36	2138.67
7919A5TRV1VSULP3	-	95	130	18	1351.17
7919A5TRV1VSUMP3	-	95	130	18	1390.14
7920CTRDULP3	7920CTRDULP3	100	140	40	2226.06
7920CTRDUMP3	7920CTRDUMP3	100	140	40	2292.83
7920CTRV1VSULP3	-	100	140	20	1446.93
7920CTRV1VSUMP3	-	100	140	20	1490.34
7920A5TRDULP3	7920A5TRDULP3	100	140	40	2226.06
7920A5TRDUMP3	7920A5TRDUMP3	100	140	40	2292.83
7920A5TRV1VSULP3	-	100	140	20	1446.93
7920A5TRV1VSUMP3	-	100	140	20	1490.34
7921CTRDULP3	7921CTRDULP3	105	145	40	2844.98
-	7921CTRDUMP3	105	145	40	2927.01
7921A5TRDULP3	7921A5TRDULP3	105	145	40	2844.98
7921A5TRDUMP3	7921A5TRDUMP3	105	145	40	2927.01
7922CTRDULP3	7922CTRDULP3	110	150	40	3245.03
7922CTRDUMP3	7922CTRDUMP3	110	150	40	3342.36
7922A5TRDULP3	7922A5TRDULP3	110	150	40	3245.03
7922A5TRDUMP3	7922A5TRDUMP3	110	150	40	3342.36
7924CTRDULP3	7924CTRDULP3	120	165	44	3754.49
7924CTRDUMP3	7924CTRDUMP3	120	165	44	3867.13
7924A5TRDULP3	7924A5TRDULP3	120	165	44	3754.49
7924A5TRDUMP3	7924A5TRDUMP3	120	165	44	3867.13
7926CTRDULP3	7926CTRDULP3	130	180	48	4256.14
7926A5TRDULP3	7926A5TRDULP3	130	180	48	4256.14
7926A5TRDUMP3	7926A5TRDUMP3	130	180	48	4383.82
7928CTRDUMP3	7928CTRDUMP3	140	190	48	4944.92
7928A5TRDULP3	7928A5TRDULP3	140	190	48	4800.89
7928A5TRDUMP3	7928A5TRDUMP3	140	190	48	4944.92
7930CTRDUMP3	7930CTRDUMP3	150	210	56	5457.59
7932CTRDULP3	7932CTRDULP3	160	220	56	6662.46
7932A5TRDULP3	7932A5TRDULP3	160	220	56	6662.46
7932A5TRDUMP3	7932A5TRDUMP3	160	220	56	6862.34
7934CTRDULP3	7934CTRDULP3	170	230	56	8034.17

Super Precision Bearings  
Hochgenauigkeitslager  
Roulements de Précision  
Rodamientos de Superprecisión  
Cuscinetti di Super Precisione  
Högprecisionslager

NSK	RHP	d	D	B	€
7934CTRDUMP3	7934CTRDUMP3	170	230	56	8275.20
7936CTRDULP3	7936CTRDULP3	180	250	66	9680.17
7936CTRDUMP3	7936CTRDUMP3	180	250	66	9970.61
7936A5TRDUMP3	7936A5TRDUMP3	180	250	66	9970.61
7938CTRDULP3	7938CTRDULP3	190	260	66	12149.21
7938A5TRDUMP3	7938A5TRDUMP3	190	260	66	12513.68
7940A5TRDUMP3	7940A5TRDUMP3	200	280	76	15379.73
-	T7004CTDULP3	20	42	24	556.05
-	T7005CTDULP3	25	47	24	556.05
-	T7006CTDULP3	30	55	26	577.53
-	T7007CTDULP3	35	62	28	655.36
-	T7008CTDULP3	40	68	30	814.75
-	T7009CTDULP3	45	75	32	892.62
-	T7010CTDULP3	50	80	32	922.62
-	T7011CTDULP3	55	90	36	1082.45
-	T7012CTDULP3	60	95	36	1189.55
-	T7013CTDULP3	65	100	36	1298.09
-	T7014CTDULP3	70	110	40	1534.73
-	T7015CTDULP3	75	115	40	1616.30
-	T7016CTDULP3	80	125	44	1755.63
-	T7017CTDULP3	85	130	44	1935.55
-	T7018CTDULP3	90	140	48	2293.98
17TAC47BSUC10PN7B	-	17	47	15	283.70
-	BSB017047DUHP3	17	47	30	567.41
20TAC47BSUC10PN7B	-	20	47	15	283.70
-	BSB020047DUHP3	20	47	30	567.41
25TAC62BSUC10PN7B	-	25	62	15	321.07
-	BSB025062DUHP3	25	62	30	642.20
30TAC62BSUC10PN7B	-	30	62	15	324.93
-	BSB030062DUHP3	30	62	30	649.85
30TAC72BSUC10PN7B	-	30	72	15	336.42
-	BSB030072DUHP3	30	72	30	672.83
35TAC72BSUC10PN7B	-	35	72	15	336.42
-	BSB035072DUHP3	35	72	30	672.84
40TAC72BSUC10PN7B	-	40	72	15	346.09
-	BSB040072DUHP3	40	72	30	692.12
40TAC90BSUC10PN7B	-	40	90	20	430.00
-	BSB040100DUHP3	40	100	40	984.75
-	BSB045075DUHP3	45	75	30	633.79
45TAC100BSUC10PN7B	-	45	100	20	513.73

Super Precision Bearings  
Hochgenauigkeitslager  
Roulements de Précision  
Rodamientos de Superprecisión  
Cuscinetti di Super Precisione  
Högprecisionslager

NSK	RHP	d	D	B	€
-	BSB045100DUHP3	45	100	40	1027.45
-	BSB050100DUHP3	50	100	40	1146.35
-	BSB055090DUHP3	55	90	30	1213.43
-	BSB060120DUHP3	60	120	40	1518.68
-	BSB075110DUHP3	75	110	30	1920.78
-	BSB078DUHP3	20	47	31.75	580.55
-	BSB093DUHP3	23.838	62	31.75	652.81
-	BSB100150DUHP3	100	150	45	3032.67
-	BSB150DUHP3	38.1	72	31.75	721.61
-	BSB2030DUHP3	30	62	32	682.34
-	BSB225DUHP3	57.15	90	31.75	1428.67
NN3012MBKRCC1P4	-	60	95	26	788.04
NN3013MBKRCC1P4	-	65	100	26	788.04
NN3014MBKRE44CC1P4	-	70	110	30	853.87
NN3015MBKRCC1P4	-	75	115	30	858.00
NN3016MBKRE44CC1P4	-	80	125	34	909.44
NN3017MBKRCC1P4	-	85	130	34	995.86
NN3018MBKRE44CC1P4	-	90	140	37	1183.09
NN3019MBKRE44CC1P4	-	95	145	37	1300.01
NN3020MBKRCC1P4	-	100	150	37	1337.36
NN3021MBKRCC1P4	-	105	160	41	1509.64
NN3022MBKRCC1P4	-	110	170	45	1584.30
NN3024MBKRE44CC1P4	-	120	180	46	1810.61
NN3026MBKRE2CC1P4	-	130	200	52	2222.15
NN3028MBKRE2CC1P4	-	140	210	53	2469.01
NN3030MBKRE1CC1P4	-	150	225	56	2921.71
NNU4920MBKRE2CC2P4	-	100	140	40	1350.13
NNU4926MBKRE3CC1P4	-	130	180	50	1959.56
NNU4928MBKRE2CC1P4	-	140	190	50	2253.49
NNU4930MBKRE2CC1P4	-	150	210	60	2672.83
NNU4932MBKRE2CC1P4	-	160	220	60	3429.23
NNU4934MBKRE3CC1P4	-	170	230	60	3958.30
NNU4936MBKRE1CC1P4	-	180	250	69	4977.25
NNU4938MBKRE1CC1P4	-	190	260	69	6113.81

**BSBD Ball Screw Support Bearings - BSBD Series**

**Axial-Schrägkugellager für Kugelgewindetriebe  
- BSBD-Serie**

**Séries BSBD - Roulements Support de Vis à Billes**

**Serie BSF/BSN – Rodamientos para Soportes de Husillos  
a Bolas**

**Cuscinetti per supporto di viti a ricircolazione di sfere  
della Serie BSBD**

**BSBD Kulskruvslager - BSBD Serien**

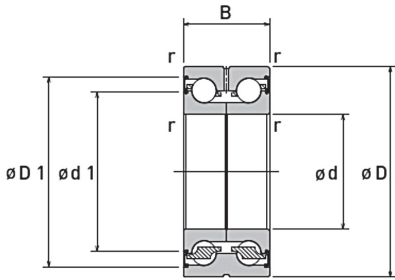

BSN type - single

(example - BSN3062DDUHP3)

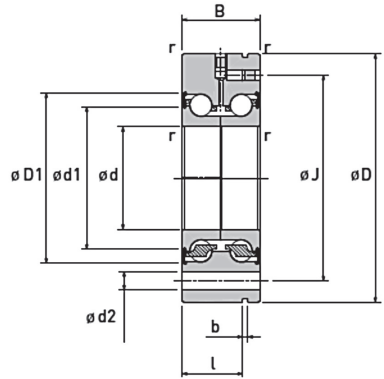

BSF type - single unit

(example - BSF3080DDUHP3)

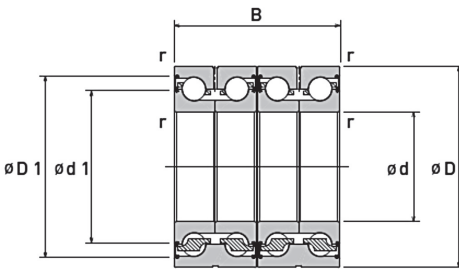

BSN type - DT (pair)

(example - BSN3062DDUDTHP3)

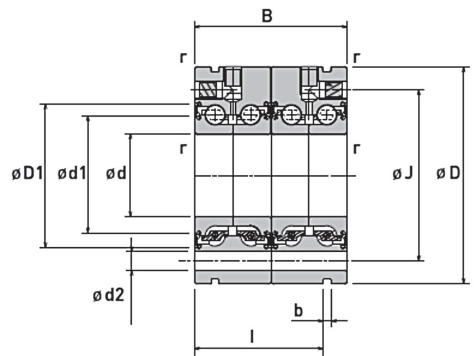

BSF type - DT (pair)

(example - BSF3080DDUDTHP3)



BSBD Ball Screw Support Bearings - BSBD Series  
 Axial-Schrägkugellager für Kugelgewindetriebe - BSBD-Serie  
 Séries BSBD - Roulements Support de Vis à Billes  
 Serie BSF/BSN – Rodamientos para Soportes de Husillos a Bolas  
 Cuscinetti per supporto di viti a ricircolazione di sfere della Serie BSBD  
 BSBD Kulskrivslager - BSBD Serien

NSK	RHP	d	D	B	€
BSF1762DDUHP3	-	17	62	25	1021.34
BSF2068DDUDTHP3	-	20	68	56	2156.15
BSF2068DDUHP3	-	20	68	28	1078.08
BSF2575DDUDTHP3	-	25	75	56	2311.91
BSF2575DDUHP3	-	25	75	28	1155.96
BSF30100DDUDTHP3	-	30	100	76	2556.75
BSF30100DDUHP3	-	30	100	38	1278.38
BSF3080DDUDTHP3	-	30	80	56	2422.18
BSF3080DDUHP3	-	30	80	28	1211.09
BSF3590DDUDTHP3	-	35	90	68	2422.22
BSF3590DDUHP3	-	35	90	34	1211.11
BSF40100DDUDTHP3	-	40	100	68	3545.14
BSF40100DDUHP3	-	40	100	34	1772.57
BSF40115DDUDTHP3	-	40	115	92	3545.14
BSF40115DDUHP3	-	40	115	46	1772.57
BSF50115DDUDTHP3	-	50	115	68	4126.84
BSF50115DDUHP3	-	50	115	34	2063.42
BSN1747DDUHP3	-	17	47	25	817.07
BSN2052DDUHP3	-	20	52	28	862.46
BSN2557DDUHP3	-	25	57	28	924.77
BSN3062DDUDTHP3	-	30	62	56	1937.75
BSN3062DDUHP3	-	30	62	28	968.88
BSN3072DDUDTHP3	-	30	72	76	2045.40
BSN3072DDUHP3	-	30	72	38	1022.70
BSN3572DDUDTHP3	-	35	72	68	1937.78
BSN3572DDUHP3	-	35	72	34	968.89
BSN4075DDUDTHP3	-	40	75	68	2836.11
BSN4075DDUHP3	-	40	75	34	1418.06
BSN4090DDUDTHP3	-	40	90	92	2836.11
BSN4090DDUHP3	-	40	90	46	1418.06
BSN5090DDUHP3	-	50	90	34	1650.74



**RHP Self-Lube® and Silver-Lube®**

**RHP Self-Lube® und Silver-Lube® Gehäuselager**

**Roulements et paliers auto-aligneurs gamme  
Self-Lube® et anti-corrosion Silver-Lube®**

**RHP Self-Lube® y Silver-Lube®**

**Supporti orientabili RHP Self-Lube® e supporti  
anticorrosione RHP Silver-Lube®**

**RHP Self-Lube® och Silver-Lube®**

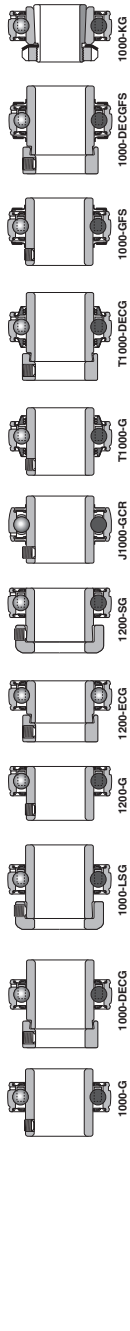

	1000-G	1000-DECG	1000-LSG	1200-G	1200-ECG	1200-SG	J1000-GCR	T1000-G	T1000-DECG	1000-GFS	1000-DECGFS	1000-KG
NP NP MP	NP-DEC SL-DEC	NP-DEC SL-DEC	NP-LS SL-LS	NP-A SL-A	NP-EC SL-EC	NP-S SL-S	PNP-CR	TNP TNP TNP	TNP-DEC TSL-DEC	NP-FS TNP-FS MP-FS	NP-DECFS SL-DECFS	NP1000-K
SNP CNP	SNP-DEC CNP-DEC	SNP-DEC CNP-DEC	SNP-LS CNP-LS	SNP-A CNP-A	SNP-EC CNP-EC	SNP-S CNP-S		TSNP TONP	TSNP-DEC TONP-DEC	SNP-FS CNP-FS	SNP-DECFS CNP-DECFS	SNP-DECFS CNP-DECFS
SF MSF	SF-DEC	SF-DEC	SF-LS	SF-A	SF-EC	SF-S	PSF-CR	TSF TMSF	TSF-DEC	SF-FS MSF-FS	SF-DECFS	MSF1000-K
SFT MSFT	SFT-DEC	SFT-DEC	SFT-LS	SFT-A	SFT-EC	SFT-S	PSFT-CR	TSFT TMSFT	TSFT-DEC	SFT-FS MSFT-FS	SFT-DECFS	MSFT1000-K
LFTC	LFTC-DEC	LFTC-DEC	LFTC-LS	LFTC-A	LFTC-EC	LFTC-S		TLFTC	TLFTC-DEC	LFTC-FS	LFTC-DECFS	
FC	FC-DEC	FC-DEC	FC-LS	FC-A	FC-EC	FC-S		TFC	TFC-DEC	FC-FS	FC-DECFS	
MFC								TMFC		MFC-FS		
ST MST	ST-DEC	ST-DEC	ST-LS	ST-A	ST-EC	ST-S	PST-CR	TST TMST	TST-DEC	ST-FS MST-FS	ST-DECFS	MST1000-K
BT				BT-A	BT-EC	BT-S		TBT		BT-FS		
S/C M/S	S/C-DEC	S/C-DEC	S/C-LS	S/C-A	S/C-EC	S/C-S		TMSC	TSLC-DEC	S/C-FS M/S-FS	S/C-DECFS	
SCHB SCH								TSCHB TSCH		SCHB-FS SCH-FS		
S/LFE	S/LFE-DEC	S/LFE-DEC	S/LFE-LS	S/LFE-A	S/LFE-EC	S/LFE-S		TS/LFE	TS/LFE-DEC	S/LFE-FS	S/LFE-DECFS	
S/LFT	S/LFT-DEC	S/LFT-DEC	S/LFT-LS	S/LFT-A	S/LFT-EC	S/LFT-S		TS/LFT	TS/LFT-DEC	S/LFT-FS	S/LFT-DECFS	
S/LFL	S/LFL-DEC	S/LFL-DEC	S/LFL-LS	S/LFL-A	S/LFL-EC	S/LFL-S		TS/LFL	TS/LFL-DEC	S/LFL-FS	S/LFL-DECFS	
LPB LPBR	LPB-DEC LPBR-DEC	LPB-DEC LPBR-DEC	LPB-LS LPBR-LS	LPB-A LPBR-A	LPB-EC LPBR-EC	LPB-S LPBR-S						
	SRM-EC	SRC-EC			2300A-EC	1600-G		1600-HG		1700		1700-H

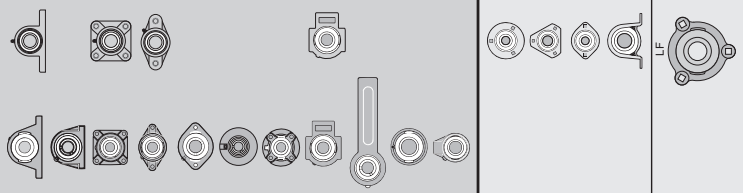

RHP Self-Lube® and Silver-Lube®

RHP Self-Lube® und Silver-Lube® Gehäuselager

Roulements et paliers auto-aligneurs gamme Self-Lube® et anti-corrosion Silver-Lube®

RHP Self-Lube® y Silver-Lube®

Supporti orientabili RHP Self-Lube® e supporti anticorrosione RHP Silver-Lube®

RHP Self-Lube® och Silver-Lube®

NSK	€	NSK	€
Bearing Inserts		1030-1GFS	*
Gehäuselagereinsätze		1030-1GHLT	*
Roulements de paliers		1030-1KG	*
Insertos		1030-1.1/16G	*
Inserti Self-Lube®		1030-1.1/8G	*
Insatslager			
1017-1/2G	*	1030-1.1/8GHLT	*
1017-11/16G	*	1030-1.1/8DECG	*
1017-12G	*	1030-1.3/16G	*
1017-15G	*	1030-1.3/16GHLT	*
1017-15GHLT	*	1030-1.3/16DECG	*
1017-16G	*	1030-1.1/4G	*
1017-16GHLT	*	1030-1.1/4GFS	*
1017-17G	*	1030-1.1/4GHLT	*
1017-17GHLT	*	1030-1.1/4DECG	*
1017-5/8G	*	1030-1.1/4LSG	*
1017-5/8GHLT	*	1030-25G	*
1017-5/8DECG	*	1030-25G-2ZFS	*
1020-20G	*	1030-25GHLT	*
1020-20GHLT	*	1030-25KG	*
1020-20DECG	*	1030-30G	*
1020-20LSG	*	1030-30G-2ZFS	*
1020-3/4G	*	1030-30GFS	*
1020-3/4GHLT	*	1030-30GHLT	*
1020-3/4DECG	*	1030-30DECG	*
1025-15/16G	*	1030-30LSG	*
1025-1G	*	1035-1.1/8G	*
1025-1GHLT	*	1035-1.3/16G	*
1025-1DECG	*	1035-1.1/4G	*
1025-25G	*	1035-1.1/4GHLT	*
1025-25GFS	*	1035-1.1/4DECG	*
1025-25GHLT	*	1035-1.1/4LSG	*
1025-25G-2ZFS	*	1035-1.3/8G	*
1025-25DECG	*	1035-1.3/8GHLT	*
1025-25LSG	*	1035-1.3/8DECG	*
1025-3/4KG	*	1035-1.7/16G	*
1025-3/4KGHLT	*	1035-1.7/16GHLT	*
1025-7/8G	*	1035-1.7/16DECG	*
1025-7/8GHLT	*	1035-30G	*
1025KG	*	1035-30G-2ZFS	*
1030-1G	*	1035-30GHLT	*

RHP Self-Lube® and Silver-Lube®  
 RHP Self-Lube® und Silver-Lube® Gehäuselager  
 Roulements et paliers auto-aligneurs gamme Self-Lube® et anti-corrosion Silver-Lube®  
 RHP Self-Lube® y Silver-Lube®  
 Supporti orientabili RHP Self-Lube® e supporti anticorrosione RHP Silver-Lube®  
 RHP Self-Lube® och Silver-Lube®

NSK	€	NSK	€
1035-30KG	*	1050-1.11/16G	*
1035-35G	*	1050-1.3/4G	*
1035-35GFS	*	1050-1.3/4GHLT	*
1035-35GHLT	*	1050-1.3/4KG	*
1035-35DECG	*	1050-1.7/8G	*
1035KG	*	1050-1.15/16G	*
1040-1.1/4KG	*	1050-1.15/16GHLT	*
1040-1.3/8G	*	1050-1.15/16DECG	*
1040-1.7/16G	*	1050-2G	*
1040-1.1/2G	*	1050-2DECG	*
1040-1.1/2GHLT	*	1050-45G	*
1040-1.1/2DECG	*	1050-45GHLT	*
1040-1.9/16G	*	1050-45KG	*
1040-35G	*	1050-50G	*
1040-35GHLT	*	1050-50GFS	*
1040-35KG	*	1050-50GHLT	*
1040-40G	*	1050KG	*
1040-40GFS	*	1050-50DECG	*
1040-40GHLT	*	1055-1.7/8GHLT	*
1040-40DECG	*	1055-1.15/16G	*
1040-40LSG	*	1055-1.15/16DLG	*
1045-1.1/2G	*	1055-2.1/8G	*
1045-1.1/2GHLT	*	1055-2.3/16G	*
1045-1.5/8G	*	1055-2.3/16GHLT	*
1045-1.5/8DECG	*	1055-2.3/16DECG	*
1045-1.11/16G	*	1055-2G	*
1045-1.11/16GHLT	*	1055-2GFS	*
1045-1.11/16DECG	*	1055-2GHLT	*
1045-1.3/4G	*	1055-2DECG	*
1045-1.3/4GHLT	*	1055-2KG	*
1045-1.3/4DECG	*	1055-50G	*
1045-40G	*	1055-50GHLT	*
1045-40GHLT	*	1055-50KG	*
1045-40KG	*	1055-55G	*
1045-45DECG	*	1055-55GFS	*
1045-45DECGFS	*	1055-55GHLT	*
1045-45G	*	1055-55DECG	*
1045-45GFS	*	1055KG	*
1045-45GHLT	*	1060-2.3/16G	*
1045KG	*	1060-2.1/4G	*

RHP Self-Lube® and Silver-Lube®

RHP Self-Lube® und Silver-Lube® Gehäuselager

Roulements et paliers auto-aligneurs gamme Self-Lube® et anti-corrosion Silver-Lube®

RHP Self-Lube® y Silver-Lube®

Supporti orientabili RHP Self-Lube® e supporti anticorrosione RHP Silver-Lube®

RHP Self-Lube® och Silver-Lube®

NSK	€	NSK	€
1060-2.1/4GHLT	*	1075-70G	*
1060-2.1/4DECG	*	1075-70GHLT	*
1060-2.3/8G	*	1075-75G	*
1060-2.3/8GHLT	*	1075-75GHLT	*
1060-2.7/16G	*	1075-75DECG	*
1060-2.7/16DECG	*	1080-2.15/16G	*
1060-2.1/2LCG	*	1080-2.15/16GHLT	*
1060-55G	*	1080-3G	*
1060-55GHLT	*	1080-3GHLT	*
1060-60G	*	1080-3.1/4G	*
1060-60GFS	*	1080-75G	*
1060-60GHLT	*	1080-75GHLT	*
1060-60DECG	*	1080-80G	*
1065-2.1/2G	*	1080-80GHLT	*
1065-2.1/2DECG	*	1085-3.3/16G	*
1065-60G	*	1085-3.1/4G	*
1065-65G	*	1085-3.3/8G	*
1065-65GHLT	*	1085-3.7/16G	*
1070-2.1/2G	*	1085-80G	*
1070-2.1/2GHLT	*	1085-80GHLT	*
1070-2.11/16G	*	1085-85G	*
1070-2.7/16G	*	1090-3.7/16G	*
1070-60G	*	1090-3.7/16GHLT	*
1070-60GHLT	*	1090-3.1/2G	*
1070-65G	*	1090-3.1/2GHLT	*
1070-70G	*	1090-85G	*
1070-70GHLT	*	1090-85GHLT	*
1070-70DECG	*	1090-90G	*
1075-2.5/8G	*	1090-90GHLT	*
1075-2.11/16G	*	1117-1/2	*
1075-2.11/16GHLT	*	1117-12	*
1075-2.3/4G	*	1117-15	*
1075-2.3/4GHLT	*	1117-16	*
1075-2.7/8G	*	1117-5/8	*
1075-2.15/16G	*	1120-20	*
1075-2.15/16GHLT	*	1120-20HLT	*
1075-2.15/16DECG	*	1120-20CG	*
1075-3G	*	1120-20DEC	*
1075-65G	*	1120-3/4	*
1075-65GHLT	*	1120-3/4HLT	*

RHP Self-Lube® and Silver-Lube®  
 RHP Self-Lube® und Silver-Lube® Gehäuselager  
 Roulements et paliers auto-aligneurs gamme Self-Lube® et anti-corrosion Silver-Lube®  
 RHP Self-Lube® y Silver-Lube®  
 Supporti orientabili RHP Self-Lube® e supporti anticorrosione RHP Silver-Lube®  
 RHP Self-Lube® och Silver-Lube®

NSK	€	NSK	€
1120-3/4CG	*	1145-45CG	*
1125-1	*	1150-1.15/16	*
1125-1DEC	*	1150-1.15/16CG	*
1125-25	*	1150-50	*
1125-25CG	*	1150-50HLT	*
1125-25DEC	*	1155-2	*
1125-7/8	*	1155-2.3/16DEC	*
1125-7/8CG	*	1160-2.7/16	*
1130-1	*	1160-2.7/16CG	*
1130-1.1/8CG	*	1160-60	*
1130-1.3/16	*	1160-60HLT	*
1130-1.3/16CG	*	1170-70HLT	*
1130-1.1/4	*	1175-2.15/16	*
1130-25	*	1175-2.15/16DEC	*
1130-30	*	1217-1/2ECG	*
1130-30HLT	*	1217-12G	*
1130-30CG	*	1217-12ECG	*
1130-30DEC	*	1217-15G	*
1135-1.1/4	*	1217-15ECG	*
1135-1.1/4CG	*	1217-16ECG	*
1135-1.3/8CG	*	1217-17G	*
1135-1.3/8DEC	*	1217-17ECG	*
1135-1.7/16	*	1217-5/8G	*
1135-1.7/16CG	*	1217-5/8ECG	*
1135-1.7/16DEC	*	1220-20G	*
1135-30	*	1220-20ECG	*
1135-35	*	1220-20ECGHLT	*
1135-35CG	*	1220-3/4G	*
1140-1.1/2	*	1220-3/4ECG	*
1140-1.1/2CG	*	1220-3/4SG	*
1140-1.1/2DEC	*	1225-7/8ECG	*
1140-40	*	1225-15/16G	*
1140-40CG	*	1225-1G	*
1140-40DEC	*	1225-1GHLT	*
1145-1.1/2	*	1225-1ECG	*
1145-1.11/16	*	1225-25G	*
1145-1.11/16CG	*	1225-25GHLT	*
1145-1.3/4CG	*	1225-25ECG	*
1145-40	*	1225-25ECGHLT	*
1145-45	*	1225-25SG	*



RHP Self-Lube® and Silver-Lube®  
 RHP Self-Lube® und Silver-Lube® Gehäuselager  
 Roulements et paliers auto-aligneurs gamme Self-Lube® et anti-corrosion Silver-Lube®  
 RHP Self-Lube® y Silver-Lube®  
 Supporti orientabili RHP Self-Lube® e supporti anticorrosione RHP Silver-Lube®  
 RHP Self-Lube® och Silver-Lube®

NSK	€	NSK	€
1230-1.1/8ECG	*	1320-3/4	*
1230-1.3/16ECG	*	1320-3/4EC	*
1230-1.1/4G	*	1325-7/8EC	*
1230-1.1/4ECG	*	1325-1	*
1230-30G	*	1325-1EC-2Z	*
1230-30ECG	*	1325-25	*
1230-30ECGHLT	*	1325-25EC	*
1235-1.1/4G	*	1325-25EC-2Z	*
1235-1.1/4ECG	*	1330-1.1/8EC	*
1235-1.3/8ECG	*	1330-1.3/16EC	*
1235-1.7/16G	*	1330-1.1/4EC	*
1235-1.7/16ECG	*	1330-30EC	*
1235-35G	*	1335-1.7/16EC	*
1235-35GHLT	*	1335-1.1/4EC	*
1235-35ECG	*	1335-35EC	*
1235-35ECGHLT	*	1340-1.1/2EC	*
1240-1.1/2G	*	1340-40EC	*
1240-1.1/2ECG	*	1345-45EC	*
1240-40G	*	1350-1.15/16EC	*
1240-40GHLT	*	1350-50EC	*
1240-40ECG	*	1726204-2RS	*
1240-40ECGHLT	*	1726205-2RS	*
1240-40SG	*	1726206-2RS	*
1245-1.5/8ECG	*	1726207-2RS	*
1245-1.11/16ECG	*	1726208-2RS	*
1245-1.3/4ECG	*	1726209-2RS	*
1245-45G	*	1726210-2RS	*
1245-45ECG	*	3095-100G	*
1250-1.15/16ECG	*	3095-100GHLT	*
1250-2ECG	*	3095-3.15/16G	*
1250-50G	*	3095-4G	*
1250-50-2Z	*	3095-4GHLT	*
1250-50ECG	*	3095-95G	*
1250-50ECGHLT	*	3095-95GHLT	*
1255-2ECG	*	3140-1.1/2DEC	*
1255-55ECG	*	T1025-1G	*
1317-15EC	*	T1025-1DECG	*
1317-17EC	*	T1025-25G	*
1317-5/8EC	*	T1025-25DECG	*
1320-20EC	*	T1030-30G	*

RHP Self-Lube® and Silver-Lube®  
 RHP Self-Lube® und Silver-Lube® Gehäuselager  
 Roulements et paliers auto-aligneurs gamme Self-Lube® et anti-corrosion Silver-Lube®  
 RHP Self-Lube® y Silver-Lube®  
 Supporti orientabili RHP Self-Lube® e supporti anticorrosione RHP Silver-Lube®  
 RHP Self-Lube® och Silver-Lube®

NSK	€	NSK	€
T1030-30DECG	*	BT25EC	*
T1035-35G	*	BT30L	*
T1035-35DECG	*	BT35	*
T1040-1.1/2G	*	BT35A	*
T1040-35G	*	BT35DEC	*
T1040-40G	*	BT35EC	*
T1040-40DECG	*	CNP3/4	*
T1045-40G	*	CNP1	*
T1045-45DECG	*	CNP1EC	*
T1050-45G	*	CNP1.3/16	*
T1050-50G	*	CNP1.3/16EC	*
T1050-50DECG	*	CNP1.1/4	*
T1055-2G	*	CNP1.7/16	*
T1055-50G	*	CNP1.1/2	*
T1055-55G	*	CNP25	*
T1060-2.1/4G	*	CNP30	*
T1060-55G	*	CNP35	*
T1060-60G	*	FC3/4A	*
T1070-60G	*	FC7/8	*
T1070-65G	*	FC1	*
T1070-70G	*	FC1.3/8	*
T1080-3G	*	FC1.1/4	*
T1080-75G	*	FC1.1/2	*
T1080-80G	*	FC2	*
		FC20	*
Units		FC20A	*
Gehäuselagereinheiten		FC20EC	*
Paliers		FC25	*
Soportes con rodamiento NSK, Pillow Block		FC25A	*
Supporti orientabili NSK		FC25DEC	*
Komplettta enheter			
AR3/4EC	*	FC25EC	*
AR1EC	*	FC30	*
AR20EC	*	FC30A	*
AR25EC	*	FC30DEC	*
BT1	*	FC30EC	*
BT1.1/4	*	FC35	*
BT1.3/8	*	FC35HLT	*
BT1.7/16	*	FC35A	*
BT25	*	FC35DEC	*
BT25A	*	FC35EC	*

RHP Self-Lube® and Silver-Lube®

RHP Self-Lube® und Silver-Lube® Gehäuselager

Roulements et paliers auto-aligneurs gamme Self-Lube® et anti-corrosion Silver-Lube®

RHP Self-Lube® y Silver-Lube®

Supporti orientabili RHP Self-Lube® e supporti anticorrosione RHP Silver-Lube®

RHP Self-Lube® och Silver-Lube®

NSK	€	NSK	€
FC40	*	LFTC1.3/8	*
FC40HLT	*	LFTC1.7/16	*
FC40A	*	LFTC12	*
FC40DEC	*	LFTC12EC	*
FC40EC	*	LFTC15	*
FC40FS	*	LFTC15A	*
FC45	*	LFTC15EC	*
FC45A	*	LFTC16	*
FC45DEC	*	LFTC17	*
FC45EC	*	LFTC17A	*
FC50	*	LFTC17EC	*
FC50EC	*	LFTC20	*
FC55	*	LFTC20HLT	*
FC60	*	LFTC20A	*
FC60DEC	*	LFTC20EC	*
LF1	*	LFTC25	*
LF1.1/4	*	LFTC25A	*
LF25	*	LFTC25EC	*
LF30	*	LFTC30	*
LFG25	*	LFTC30HLT	*
LFG35DEC	*	LFTC30A	*
LFTC1/2	*	LFTC30EC	*
LFTC5/8	*	LFTC35	*
LFTC5/8A	*	LFTC35A	*
LFTC5/8EC	*	LFTC35EC	*
LFTC3/4	*	LPB1/2	*
LFTC3/4A	*	LPB5/8	*
LFTC3/4EC	*	LPB3/4	*
LFTC7/8	*	LPB3/4EC	*
LFTC15/16	*	LPB7/8	*
LFTC1	*	LPB1	*
LFTC1HLT	*	LPB1HLT	*
LFTC1A	*	LPB1A	*
LFTC1EC	*	LPB1EC	*
LFTC1S	*	LPB1.1/4	*
LFTC1.1/8	*	LPB1.7/16	*
LFTC1.3/16	*	LPB12	*
LFTC1.3/16EC	*	LPB12EC	*
LFTC1.1/4	*	LPB15	*
LFTC1.1/4A	*	LPB15A	*

RHP Self-Lube® and Silver-Lube®  
 RHP Self-Lube® und Silver-Lube® Gehäuselager  
 Roulements et paliers auto-aligneurs gamme Self-Lube® et anti-corrosion Silver-Lube®  
 RHP Self-Lube® y Silver-Lube®  
 Supporti orientabili RHP Self-Lube® e supporti anticorrosione RHP Silver-Lube®  
 RHP Self-Lube® och Silver-Lube®

NSK	€	NSK	€
LPB16	*	MFC1.3/8	*
LPB17	*	MFC1.3/4	*
LPB17A	*	MFC1.7/16	*
LPB20	*	MFC1.1/2	*
LPB20A	*	MFC1.1/2HLT	*
LPB20EC	*	MFC1.1/2EC	*
LPB25	*	MFC1.11/16	*
LPB25HLT	*	MFC1.15/16	*
LPB25A	*	MFC2	*
LPB25DEC	*	MFC2.3/16	*
LPB25EC	*	MFC2.1/4	*
LPB30	*	MFC2.7/16	*
LPB30A	*	MFC2.1/2	*
LPB30EC	*	MFC2.11/16	*
LPB35	*	MFC2.3/4	*
LPB35A	*	MFC2.15/16	*
LPB35EC	*	MFC3	*
LPBR1/2	*	MFC3HLT	*
LPBR3/4	*	MFC3.1/4	*
LPBR3/4EC	*	MFC3.7/16	*
LPBR5/8	*	MFC3.1/2	*
LPBR5/8EC	*	MFC3.1/2HLT	*
LPBR15/16	*	MFC3.15/16	*
LPBR1	*	MFC4	*
LPBR1EC	*	MFC25	*
LPBR1.1/4	*	MFC25HLT	*
LPBR1.3/16	*	MFC30	*
LPBR12	*	MFC30HLT	*
LPBR15	*	MFC35	*
LPBR17	*	MFC35HLT	*
LPBR20	*	MFC35R	*
LPBR25	*	MFC40	*
LPBR25EC	*	MFC40HLT	*
LPBR30	*	MFC40EC	*
LPBR30EC	*	MFC45	*
MFC1	*	MFC45HLT	*
MFC1.1/8	*	MFC50	*
MFC1.3/16	*	MFC50HLT	*
MFC1.1/4	*	MFC50ECR	*
MFC1.1/4R	*	MFC55	*

RHP Self-Lube® and Silver-Lube®  
 RHP Self-Lube® und Silver-Lube® Gehäuselager  
 Roulements et paliers auto-aligneurs gamme Self-Lube® et anti-corrosion Silver-Lube®  
 RHP Self-Lube® y Silver-Lube®  
 Supporti orientabili RHP Self-Lube® e supporti anticorrosione RHP Silver-Lube®  
 RHP Self-Lube® och Silver-Lube®

NSK	€	NSK	€
MFC60	*	MP3HLT	*
MFC60HLT	*	MP3.1/4	*
MFC65	*	MP3.7/16	*
MFC65R	*	MP3.1/2	*
MFC70	*	MP3.1/2HLT	*
MFC70HLT	*	MP3.15/16	*
MFC75	*	MP4	*
MFC75HLT	*	MP25	*
MFC80	*	MP30	*
MFC85	*	MP30HLT	*
MFC85HLT	*	MP35	*
MFC90	*	MP35HLT	*
MFC90HLT	*	MP40	*
MFC95	*	MP40HLT	*
MFC100	*	MP45	*
MFC100HLT	*	MP45HLT	*
MFC1040K	*	MP50	*
MFC1055K	*	MP50HLT	*
MFCD1.15/16	*	MP55	*
MP1	*	MP60	*
MP1HLT	*	MP60HLT	*
MP1.3/16	*	MP65	*
MP1.1/4	*	MP65HLT	*
MP1.7/16	*	MP65R	*
MP1.1/2	*	MP70	*
MP1.1/2HLT	*	MP75	*
MP1.3/8	*	MP75HLT	*
MP1.11/16	*	MP80	*
MP1.3/4	*	MP80HLT	*
MP1.15/16	*	MP85	*
MP2	*	MP85HLT	*
MP2HLT	*	MP90	*
MP2.3/16	*	MP90HLT	*
MP2.1/4	*	MP95	*
MP2.7/16	*	MP100	*
MP2.1/2	*	MP100HLT	*
MP2.11/16	*	MP1035K	*
MP2.3/4	*	MP1040K	*
MP2.15/16	*	MP1045-40K	*
MP3	*	MP1045K	*

RHP Self-Lube® and Silver-Lube®  
 RHP Self-Lube® und Silver-Lube® Gehäuselager  
 Roulements et paliers auto-aligneurs gamme Self-Lube® et anti-corrosion Silver-Lube®  
 RHP Self-Lube® y Silver-Lube®  
 Supporti orientabili RHP Self-Lube® e supporti anticorrosione RHP Silver-Lube®  
 RHP Self-Lube® och Silver-Lube®

NSK	€	NSK	€
MP1050K	*	MSC75	*
MP1050-1.3/4K	*	MSC80	*
MP1050-45K	*	MSC95	*
MP1055K	*	MSC100	*
MP1055-2K	*	MSF1	*
MP1055-50K	*	MSF1.1/8	*
MPD1.15/16	*	MSF1.3/16	*
MPD2.15/16	*	MSF1.1/4	*
MSC1	*	MSF1.3/8	*
MSC1HLT	*	MSF1.7/16	*
MSC1.1/8	*	MSF1.1/2	*
MSC1.1/4	*	MSF1.11/16	*
MSC1.7/16	*	MSF1.3/4	*
MSC1.1/2	*	MSF1.15/16	*
MSC1.11/16	*	MSF2	*
MSC1.3/4	*	MSF2HLT	*
MSC1.15/16	*	MSF2.3/16	*
MSC2	*	MSF2.1/4	*
MSC2.3/16	*	MSF2.7/16	*
MSC2.1/4	*	MSF2.1/2	*
MSC2.7/16	*	MSF2.11/16	*
MSC2.1/2	*	MSF2.3/4	*
MSC2.11/16	*	MSF2.15/16	*
MSC2.3/4	*	MSF3	*
MSC2.15/16	*	MSF3HLT	*
MSC3	*	MSF3.3/16	*
MSC3.7/16	*	MSF3.1/4	*
MSC3.1/2	*	MSF3.7/16	*
MSC3.15/16	*	MSF3.7/16HLT	*
MSC4	*	MSF3.1/2	*
MSC25	*	MSF3.15/16	*
MSC30	*	MSF4	*
MSC35	*	MSF4HLT	*
MSC40	*	MSF25	*
MSC45	*	MSF30	*
MSC50	*	MSF30HLT	*
MSC55	*	MSF35	*
MSC60	*	MSF35HLT	*
MSC65	*	MSF40	*
MSC70	*	MSF40HLT	*

RHP Self-Lube® and Silver-Lube®  
 RHP Self-Lube® und Silver-Lube® Gehäuselager  
 Roulements et paliers auto-aligneurs gamme Self-Lube® et anti-corrosion Silver-Lube®  
 RHP Self-Lube® y Silver-Lube®  
 Supporti orientabili RHP Self-Lube® e supporti anticorrosione RHP Silver-Lube®  
 RHP Self-Lube® och Silver-Lube®

NSK	€	NSK	€
MSF45	*	MSFT2	*
MSF45HLT	*	MSFT2.3/16	*
MSF50	*	MSFT25	*
MSF50HLT	*	MSFT30	*
MSF55	*	MSFT35	*
MSF60	*	MSFT40	*
MSF60HLT	*	MSFT45	*
MSF65	*	MSFT50	*
MSF65HLT	*	MSFT55	*
MSF70	*	MSFT1025-20K	*
MSF75	*	MSFT1030K	*
MSF75HLT	*	MSFT1030-1K	*
MSF80	*	MSFT1030-25K	*
MSF80HLT	*	MSFT1040K	*
MSF85	*	MSFT1035-30K	*
MSF90	*	MSFT1045K	*
MSF90HLT	*	MSFT1045-40K	*
MSF95	*	MSFT1055K	*
MSF100	*	MST1	*
MSF100HLT	*	MST1.1/4	*
MSF1030-1K	*	MST1.3/8	*
MSF1030-25K	*	MST1.7/16	*
MSF1035K	*	MST1.1/2	*
MSF1035-30K	*	MST1.11/16	*
MSF1040K	*	MST1.3/4	*
MSF1045K	*	MST1.15/16	*
MSF1045-1.1/2K	*	MST2	*
MSF1045-40K	*	MST2.3/16	*
MSF1050-45K	*	MST2.1/4	*
MSF1055K	*	MST2.7/16	*
MSF1055-50K	*	MST2.1/2	*
MSFT1	*	MST2.11/16	*
MSFT1.3/16	*	MST2.3/4	*
MSFT1.1/4	*	MST2.15/16	*
MSFT1.3/8	*	MST3	*
MSFT1.7/16	*	MST3.1/4	*
MSFT1.1/2	*	MST3.7/16	*
MSFT1.11/16	*	MST3.1/2	*
MSFT1.3/4	*	MST3.1/2HLT	*
MSFT1.15/16	*	MST3.15/16	*

RHP Self-Lube® and Silver-Lube®  
 RHP Self-Lube® und Silver-Lube® Gehäuselager  
 Roulements et paliers auto-aligneurs gamme Self-Lube® et anti-corrosion Silver-Lube®  
 RHP Self-Lube® y Silver-Lube®  
 Supporti orientabili RHP Self-Lube® e supporti anticorrosione RHP Silver-Lube®  
 RHP Self-Lube® och Silver-Lube®

NSK	€	NSK	€
MST4	*	NP1	*
MST25	*	NP1HLT	*
MST30	*	NP1A	*
MST35	*	NP1DEC	*
MST40	*	NP1EC	*
MST40HLT	*	NP1.1/16	*
MST45	*	NP1.1/8	*
MST50	*	NP1.1/8HLT	*
MST50HLT	*	NP1.1/8EC	*
MST55	*	NP1.3/16	*
MST60	*	NP1.3/16DEC	*
MST60HLT	*	NP1.3/16EC	*
MST65	*	NP1.1/4	*
MST65HLT	*	NP1.1/4HLT	*
MST70	*	NP1.1/4DEC	*
MST70HLT	*	NP1.1/4EC	*
MST75	*	NP1.1/4ECR	*
MST75HLT	*	NP1.1/4R	*
MST80	*	NP1.15/16	*
MST80HLT	*	NP1.15/16DEC	*
MST85	*	NP1.15/16EC	*
MST85HLT	*	NP1.3/8	*
MST90	*	NP1.3/8DEC	*
MST90HLT	*	NP1.3/8EC	*
MST100	*	NP1.3/8HLT	*
MST1045K	*	NP1.7/16	*
MST1055K	*	NP1.7/16HLT	*
MST1055-50K	*	NP1.7/16DEC	*
NP1/2	*	NP1.7/16EC	*
NP1/2EC	*	NP1.1/2	*
NP7/8	*	NP1.1/2DEC	*
NP7/8EC	*	NP1.1/2EC	*
NP5/8	*	NP1.5/8	*
NP5/8EC	*	NP1.5/8DEC	*
NP3/4	*	NP1.5/8EC	*
NP3/4A	*	NP1.11/16	*
NP3/4DEC	*	NP1.11/16HLT	*
NP3/4EC	*	NP1.11/16DEC	*
NP3/4HLT	*	NP1.11/16EC	*
NP15/16	*	NP1.3/4	*



RHP Self-Lube® and Silver-Lube®  
 RHP Self-Lube® und Silver-Lube® Gehäuselager  
 Roulements et paliers auto-aligneurs gamme Self-Lube® et anti-corrosion Silver-Lube®  
 RHP Self-Lube® y Silver-Lube®  
 Supporti orientabili RHP Self-Lube® e supporti anticorrosione RHP Silver-Lube®  
 RHP Self-Lube® och Silver-Lube®

NSK	€	NSK	€
NP1.3/4HLT	*	NP25FS	*
NP1.3/4DEC	*	NP25A	*
NP1.3/4EC	*	NP25DEC	*
NP1.7/8	*	NP25EC	*
NP2	*	NP25S	*
NP2HLT	*	NP30	*
NP2DEC	*	NP30HLT	*
NP2EC	*	NP30A	*
NP2R	*	NP30DEC	*
NP2.1/8	*	NP30DECHLT	*
NP2.3/16	*	NP30EC	*
NP2.3/16DEC	*	NP35	*
NP2.1/4	*	NP35HLT	*
NP2.1/4HLT	*	NP35A	*
NP2.1/4DEC	*	NP35DEC	*
NP2.3/8	*	NP35EC	*
NP2.7/16	*	NP40	*
NP2.7/16DEC	*	NP40HLT	*
NP2.1/2	*	NP40A	*
NP2.11/16	*	NP40DEC	*
NP2.3/4	*	NP40EC	*
NP2.15/16	*	NP45	*
NP2.15/16DEC	*	NP45HLT	*
NP3	*	NP45A	*
NP3.1/4	*	NP45DEC	*
NP3.7/16	*	NP45EC	*
NP12	*	NP50	*
NP12EC	*	NP50HLT	*
NP15	*	NP50A	*
NP15EC	*	NP50DEC	*
NP16	*	NP50EC	*
NP17	*	NP55	*
NP17EC	*	NP55HLT	*
NP20	*	NP55DEC	*
NP20HLT	*	NP60	*
NP20A	*	NP60HLT	*
NP20DEC	*	NP60DEC	*
NP20EC	*	NP60EC	*
NP25	*	NP65	*
NP25HLT	*	NP70	*

RHP Self-Lube® and Silver-Lube®  
 RHP Self-Lube® und Silver-Lube® Gehäuselager  
 Roulements et paliers auto-aligneurs gamme Self-Lube® et anti-corrosion Silver-Lube®  
 RHP Self-Lube® y Silver-Lube®  
 Supporti orientabili RHP Self-Lube® e supporti anticorrosione RHP Silver-Lube®  
 RHP Self-Lube® och Silver-Lube®

NSK	€	NSK	€
NP70HLT	*	SCHB1	*
NP70DEC	*	SCHB1.1/4	*
NP75	*	SCHB1.3/8	*
NP75HLT	*	SCHB1.3/8HLT	*
NP75DEC	*	SCHB1.7/16	*
NP80	*	SCHB1.1/2	*
NP80HLT	*	SCHB1.3/4	*
NP85	*	SCHB1.15/16	*
NP90	*	SCHB2	*
NP90HLT	*	SCHB2.3/16	*
NP1025-3/4K	*	SCHB2.1/4	*
NP1030-1K	*	SCHB2.7/16	*
NP1030-25K	*	SCHB2.1/2	*
NP1035K	*	SCHB2.3/4	*
NP1040K	*	SCHB3	*
NP1040-35K	*	SCHB20	*
NP1045K	*	SCHB25	*
NP1045-1.1/2K	*	SCHB30	*
NP1045-40K	*	SCHB35	*
NP1050K	*	SCHB40	*
NP1055-2K	*	SCHB45	*
NP1055-50K	*	SCHB45HLT	*
SCH3/4	*	SCHB50	*
SCH1	*	SCHB55	*
SCH1.1/4	*	SCHB60	*
SCH1.1/2	*	SCHB65	*
SCH2	*	SCHB70	*
SCH20	*	SCHB75	*
SCH25	*	SCHB80	*
SCH25HLT	*	SF1/2	*
SCH30	*	SF1/2EC	*
SCH30EC	*	SF5/8	*
SCH35	*	SF5/8EC	*
SCH40	*	SF11/16	*
SCH45	*	SF3/4	*
SCH50	*	SF3/4DEC	*
SCH55	*	SF3/4EC	*
SCH60	*	SF7/8	*
SCH80	*	SF7/8EC	*
SCHB3/4	*	SF15/16	*

RHP Self-Lube® and Silver-Lube®  
 RHP Self-Lube® und Silver-Lube® Gehäuselager  
 Roulements et paliers auto-aligneurs gamme Self-Lube® et anti-corrosion Silver-Lube®  
 RHP Self-Lube® y Silver-Lube®  
 Supporti orientabili RHP Self-Lube® e supporti anticorrosione RHP Silver-Lube®  
 RHP Self-Lube® och Silver-Lube®

NSK	€	NSK	€
SF1	*	SF2HLT	*
SF1HLT	*	SF2DEC	*
SF1A	*	SF2EC	*
SF1DEC	*	SF2.1/8	*
SF1EC	*	SF2.3/16	*
SF1.1/8	*	SF2.3/16DEC	*
SF1.1/8HLT	*	SF2.1/4	*
SF1.1/8EC	*	SF2.3/8	*
SF1.3/16	*	SF2.7/16	*
SF1.3/16DEC	*	SF2.7/16DEC	*
SF1.3/16EC	*	SF2.1/2	*
SF1.1/4	*	SF2.1/2HLT	*
SF1.1/4HLT	*	SF2.11/16	*
SF1.1/4DEC	*	SF2.3/4	*
SF1.1/4EC	*	SF2.7/8	*
SF1.1/4R	*	SF2.15/16	*
SF1.3/8	*	SF2.15/16DEC	*
SF1.3/8DEC	*	SF3	*
SF1.3/8EC	*	SF12	*
SF1.7/16	*	SF15	*
SF1.7/16HLT	*	SF15EC	*
SF1.7/16DEC	*	SF16	*
SF1.7/16EC	*	SF16HLT	*
SF1.1/2	*	SF17	*
SF1.1/2HLT	*	SF17EC	*
SF1.1/2DEC	*	SF20	*
SF1.1/2EC	*	SF20A	*
SF1.5/8	*	SF20DEC	*
SF1.11/16	*	SF20EC	*
SF1.11/16DEC	*	SF25	*
SF1.11/16EC	*	SF25HLT	*
SF1.3/4	*	SF25A	*
SF1.3/4HLT	*	SF25DEC	*
SF1.3/4DEC	*	SF25EC	*
SF1.3/4EC	*	SF25FS	*
SF1.7/8	*	SF30	*
SF1.15/16	*	SF30HLT	*
SF1.15/16DEC	*	SF30A	*
SF1.15/16EC	*	SF30DEC	*
SF2	*	SF30EC	*

RHP Self-Lube® and Silver-Lube®  
 RHP Self-Lube® und Silver-Lube® Gehäuselager  
 Roulements et paliers auto-aligneurs gamme Self-Lube® et anti-corrosion Silver-Lube®  
 RHP Self-Lube® y Silver-Lube®  
 Supporti orientabili RHP Self-Lube® e supporti anticorrosione RHP Silver-Lube®  
 RHP Self-Lube® och Silver-Lube®

NSK	€	NSK	€
SF35	*	SFT3/4	*
SF35HLT	*	SFT3/4A	*
SF35A	*	SFT3/4EC	*
SF35DEC	*	SFT3/4HLT	*
SF35EC	*	SFT7/8	*
SF40	*	SFT7/8HLT	*
SF40HLT	*	SFT7/8EC	*
SF40FS	*	SFT7/8FS	*
SF40A	*	SFT15/16	*
SF40DEC	*	SFT1	*
SF40EC	*	SFT1HLT	*
SF45	*	SFT1FS	*
SF45HLT	*	SFT1A	*
SF45A	*	SFT1DEC	*
SF45DEC	*	SFT1EC	*
SF45EC	*	SFT1.1/8	*
SF50	*	SFT1.1/8EC	*
SF50HLT	*	SFT1.3/16	*
SF50A	*	SFT1.3/16HLT	*
SF50DEC	*	SFT1.3/16DEC	*
SF50EC	*	SFT1.3/16EC	*
SF55	*	SFT1.1/4	*
SF55HLT	*	SFT1.1/4HLT	*
SF55DEC	*	SFT1.1/4DEC	*
SF60	*	SFT1.1/4EC	*
SF60HLT	*	SFT1.3/8	*
SF60DEC	*	SFT1.3/8DEC	*
SF65	*	SFT1.3/8EC	*
SF65R	*	SFT1.7/16	*
SF70	*	SFT1.7/16HLT	*
SF70DEC	*	SFT1.7/16DEC	*
SF75	*	SFT1.7/16EC	*
SF75DEC	*	SFT1.1/2	*
SFT1/2	*	SFT1.1/2HLT	*
SFT1/2EC	*	SFT1.1/2EC	*
SFT5/8	*	SFT1.5/8	*
SFT5/8HLT	*	SFT1.11/16	*
SFT5/8A	*	SFT1.3/4	*
SFT5/8EC	*	SFT1.3/4EC	*
SFT11/16	*	SFT1.7/8	*

RHP Self-Lube® and Silver-Lube®  
 RHP Self-Lube® und Silver-Lube® Gehäuselager  
 Roulements et paliers auto-aligneurs gamme Self-Lube® et anti-corrosion Silver-Lube®  
 RHP Self-Lube® y Silver-Lube®  
 Supporti orientabili RHP Self-Lube® e supporti anticorrosione RHP Silver-Lube®  
 RHP Self-Lube® och Silver-Lube®

NSK	€	NSK	€
SFT1.15/16	*	SFT35HLT	*
SFT1.15/16DEC	*	SFT35FS	*
SFT1.15/16EC	*	SFT35DEC	*
SFT2	*	SFT35EC	*
SFT2EC	*	SFT35ECHLT	*
SFT2R	*	SFT40	*
SFT2.1/8	*	SFT40A	*
SFT2.3/16	*	SFT40DEC	*
SFT2.1/4	*	SFT40EC	*
SFT2.3/8	*	SFT40FS	*
SFT2.7/16	*	SFT45	*
SFT2.7/16DEC	*	SFT45HLT	*
SFT12	*	SFT45DEC	*
SFT12EC	*	SFT45DECFS	*
SFT15	*	SFT45EC	*
SFT15EC	*	SFT50	*
SFT16	*	SFT50HLT	*
SFT17	*	SFT50A	*
SFT17HLT	*	SFT50DEC	*
SFT17EC	*	SFT50EC	*
SFT20	*	SFT55	*
SFT20HLT	*	SFT55DEC	*
SFT20A	*	SFT60	*
SFT20DEC	*	SL1/2	*
SFT20EC	*	SL1/2EC	*
SFT20S	*	SL5/8	*
SFT25	*	SL5/8HLT	*
SFT25HLT	*	SL3/4	*
SFT25FS	*	SL3/4HLT	*
SFT25A	*	SL7/8	*
SFT25DEC	*	SL15/16	*
SFT25EC	*	SL1	*
SFT30	*	SL1HLT	*
SFT30HLT	*	SL1FS	*
SFT30FS	*	SL1A	*
SFT30A	*	SL1EC	*
SFT30DEC	*	SL1.1/8	*
SFT30EC	*	SL1.1/8EC	*
SFT30LS	*	SL1.3/16	*
SFT35	*	SL1.3/16EC	*

RHP Self-Lube® and Silver-Lube®  
 RHP Self-Lube® und Silver-Lube® Gehäuselager  
 Roulements et paliers auto-aligneurs gamme Self-Lube® et anti-corrosion Silver-Lube®  
 RHP Self-Lube® y Silver-Lube®  
 Supporti orientabili RHP Self-Lube® e supporti anticorrosione RHP Silver-Lube®  
 RHP Self-Lube® och Silver-Lube®

NSK	€	NSK	€
SL1.1/4	*	SL17	*
SL1.1/4HLT	*	SL17HLT	*
SL1.1/4EC	*	SL20	*
SL1.1/4R	*	SL20HLT	*
SL1.3/8	*	SL20A	*
SL1.3/8EC	*	SL20EC	*
SL1.7/16	*	SL25	*
SL1.1/2	*	SL25HLT	*
SL1.1/2HLT	*	SL25A	*
SL1.1/2EC	*	SL25DEC	*
SL1.5/8	*	SL25EC	*
SL1.11/16	*	SL30	*
SL1.3/4	*	SL30HLT	*
SL1.3/4EC	*	SL30FS	*
SL1.7/8	*	SL30DEC	*
SL1.15/16	*	SL30EC	*
SL1.15/16EC	*	SL35	*
SL2	*	SL35HLT	*
SL2HLT	*	SL35EC	*
SL2FS	*	SL40	*
SL2EC	*	SL40HLT	*
SL2R	*	SL40A	*
SL2.1/8	*	SL40DEC	*
SL2.3/16	*	SL40EC	*
SL2.3/16DEC	*	SL45	*
SL2.1/4	*	SL45HLT	*
SL2.1/4DEC	*	SL45DEC	*
SL2.3/8	*	SL45EC	*
SL2.7/16	*	SL50	*
SL2.7/16DEC	*	SL50HLT	*
SL2.1/2	*	SL50A	*
SL2.1/2HLT	*	SL50DEC	*
SL2.11/16	*	SL50EC	*
SL2.3/4	*	SL55	*
SL2.15/16	*	SL55HLT	*
SL2.15/16DEC	*	SL60	*
SL12	*	SL60HLT	*
SL15	*	SL60DEC	*
SL16	*	SL65	*
SL16HLT	*	SL65HLT	*

RHP Self-Lube® and Silver-Lube®  
 RHP Self-Lube® und Silver-Lube® Gehäuselager  
 Roulements et paliers auto-aligneurs gamme Self-Lube® et anti-corrosion Silver-Lube®  
 RHP Self-Lube® y Silver-Lube®  
 Supporti orientabili RHP Self-Lube® e supporti anticorrosione RHP Silver-Lube®  
 RHP Self-Lube® och Silver-Lube®

NSK	€	NSK	€
SL65R	*	SLC40A	*
SL70	*	SLC45	*
SL75	*	SLC45HLT	*
SL75HLT	*	SLC50	*
SLC1/2	*	SLC50HLT	*
SLC3/4	*	SLC55	*
SLC1	*	SLC60	*
SLC1.1/16	*	SLC65	*
SLC1.1/8	*	SLFE1/2	*
SLC1.3/16	*	SLFE5/8	*
SLC1.1/4	*	SLFE3/4	*
SLC1.3/8	*	SLFE7/8	*
SLC1.7/16	*	SLFE7/8EC	*
SLC1.1/2	*	SLFE1	*
SLC1.1/2HLT	*	SLFE1A	*
SLC1.11/16	*	SLFE1EC	*
SLC1.3/4	*	SLFE1.1/4	*
SLC1.3/4DEC	*	SLFE1.1/2	*
SLC1.15/16	*	SLFE1.3/4	*
SLC2	*	SLFE2	*
SLC2.1/8	*	SLFE12	*
SLC2.3/16	*	SLFE15	*
SLC2.1/4	*	SLFE15EC	*
SLC2.7/16	*	SLFE16	*
SLC2.7/16DEC	*	SLFE17	*
SLC2.1/2	*	SLFE20	*
SLC15	*	SLFE20A	*
SLC16	*	SLFE20EC	*
SLC17	*	SLFE25	*
SLC20	*	SLFE25A	*
SLC20A	*	SLFE25EC	*
SLC25	*	SLFE30	*
SLC25HLT	*	SLFE30A	*
SLC25A	*	SLFE30EC	*
SLC25EC	*	SLFE35	*
SLC30	*	SLFE35A	*
SLC30HLT	*	SLFE35EC	*
SLC35	*	SLFE40	*
SLC40	*	SLFE40A	*
SLC40HLT	*	SLFE40EC	*

RHP Self-Lube® and Silver-Lube®  
 RHP Self-Lube® und Silver-Lube® Gehäuselager  
 Roulements et paliers auto-aligneurs gamme Self-Lube® et anti-corrosion Silver-Lube®  
 RHP Self-Lube® y Silver-Lube®  
 Supporti orientabili RHP Self-Lube® e supporti anticorrosione RHP Silver-Lube®  
 RHP Self-Lube® och Silver-Lube®

NSK	€	NSK	€
SLFE45	*	SLFT1.1/4	*
SLFE45A	*	SLFT25	*
SLFE45EC	*	SLFT25A	*
SLFE50	*	SLFT25EC	*
SLFE50EC	*	SLFT30	*
SLFE55	*	SLFT30A	*
SLFE60	*	SLFT35	*
SLFEP25	*	SNP3/4	*
SLFEP30	*	SNP7/8	*
SLFL1/2	*	SNP1	*
SLFL5/8	*	SNP1HLT	*
SLFL5/8EC	*	SNP1EC	*
SLFL3/4	*	SNP1.1/4	*
SLFL3/4A	*	SNP1.3/8	*
SLFL3/4EC	*	SNP1.7/16	*
SLFL7/8	*	SNP1.1/2	*
SLFL1	*	SNP1.3/4	*
SLFL1EC	*	SNP1.15/16	*
SLFL1.1/4	*	SNP2	*
SLFL12	*	SNP2.7/16	*
SLFL12HLT	*	SNP20	*
SLFL12EC	*	SNP20HLT	*
SLFL15	*	SNP20A	*
SLFL15HLT	*	SNP20DEC	*
SLFL15A	*	SNP20EC	*
SLFL15EC	*	SNP25	*
SLFL16	*	SNP25A	*
SLFL16HLT	*	SNP25DEC	*
SLFL17	*	SNP25EC	*
SLFL17EC	*	SNP30	*
SLFL20	*	SNP30HLT	*
SLFL20A	*	SNP30FS	*
SLFL20EC	*	SNP30A	*
SLFL25	*	SNP30DEC	*
SLFL25A	*	SNP30EC	*
SLFL25EC	*	SNP35	*
SLFL30	*	SNP35HLT	*
SLFL30A	*	SNP35DEC	*
SLFL30EC	*	SNP35EC	*
SLFT1	*	SNP40	*



RHP Self-Lube® and Silver-Lube®  
 RHP Self-Lube® und Silver-Lube® Gehäuselager  
 Roulements et paliers auto-aligneurs gamme Self-Lube® et anti-corrosion Silver-Lube®  
 RHP Self-Lube® y Silver-Lube®  
 Supporti orientabili RHP Self-Lube® e supporti anticorrosione RHP Silver-Lube®  
 RHP Self-Lube® och Silver-Lube®

NSK	€	NSK	€
SNP40HLT	*	ST1.1/2HLT	*
SNP40DEC	*	ST1.1/2DEC	*
SNP40DECHLT	*	ST1.5/8	*
SNP40EC	*	ST1.11/16	*
SNP45	*	ST1.3/4	*
SNP45A	*	ST1.15/16	*
SNP45DEC	*	ST1.15/16DEC	*
SNP45EC	*	ST1.15/16EC	*
SNP50	*	ST2	*
SNP50DEC	*	ST2R	*
SNP50EC	*	ST2.3/16	*
SNP55	*	ST2.1/4	*
SNP60	*	ST2.3/8	*
SNP60DEC	*	ST2.7/16	*
SNP1045-40K	*	ST2.7/16DEC	*
SRC3/4EC	*	ST2.1/2	*
SRC1	*	ST2.3/4	*
SRC1EC	*	ST2.15/16	*
SRC20	*	ST2.15/16DEC	*
SRC25	*	ST3	*
SRC25EC	*	ST3.1/4	*
SRM1EC	*	ST3.7/16	*
SRM20EC	*	ST20	*
ST3/4	*	ST20EC	*
ST7/8	*	ST25	*
ST1	*	ST25HLT	*
ST1HLT	*	ST25EC	*
ST1FS	*	ST30	*
ST1A	*	ST30FS	*
ST1EC	*	ST30DEC	*
ST1.1/8	*	ST30EC	*
ST1.3/16	*	ST35	*
ST1.3/16EC	*	ST35HLT	*
ST1.1/4	*	ST35DEC	*
ST1.1/4EC	*	ST35EC	*
ST1.3/8	*	ST40	*
ST1.7/16	*	ST40HLT	*
ST1.7/16DEC	*	ST40DEC	*
ST1.7/16EC	*	ST40EC	*
ST1.1/2	*	ST45	*

RHP Self-Lube® and Silver-Lube®  
 RHP Self-Lube® und Silver-Lube® Gehäuselager  
 Roulements et paliers auto-aligneurs gamme Self-Lube® et anti-corrosion Silver-Lube®  
 RHP Self-Lube® y Silver-Lube®  
 Supporti orientabili RHP Self-Lube® e supporti anticorrosione RHP Silver-Lube®  
 RHP Self-Lube® och Silver-Lube®

NSK	€	NSK	€
ST45HLT	*	TNP45	*
ST45FS	*	TNP50	*
ST45EC	*	TNP50DEC	*
ST50	*	TNP60	*
ST50HLT	*	TSCH40	*
ST50DEC	*	TSCHB50	*
ST50EC	*	TSF1.1/4	*
ST55	*	TSF1.1/2	*
ST60	*	TSF30	*
ST60HLT	*	TSF30DEC	*
ST60DEC	*	TSF35	*
ST65	*	TSF35DEC	*
ST70	*	TSF40	*
ST70DEC	*	TSF40DEC	*
ST75	*	TSF45	*
ST80	*	TSF45DEC	*
TBT35DEC	*	TSF50	*
TFC30DEC	*	TSF50DEC	*
TLFG25	*	TSF55	*
TLFTC30	*	TSF55DEC	*
TMP2	*	TSF60	*
TMP35	*	TSFT1.1/2	*
TMP40	*	TSFT25	*
TMP45	*	TSFT25DEC	*
TMP55	*	TSFT30	*
TMP60	*	TSFT30DEC	*
TMSF40	*	TSFT35	*
TMSF50	*	TSFT35DEC	*
TMSF60	*	TSFT40	*
TMSFT35	*	TSFT40DEC	*
TMST35	*	TSFT45DEC	*
TMST50	*	TSFT50	*
TNP1.1/2	*	TSL1.1/2	*
TNP25	*	TSL30	*
TNP25DEC	*	TSL40	*
TNP30	*	TSL45	*
TNP30DEC	*	TSL50	*
TNP35DEC	*	TSL60	*
TNP40	*	TSLC30	*
TNP40DEC	*	TSLFE30	*

RHP Self-Lube® and Silver-Lube®  
 RHP Self-Lube® und Silver-Lube® Gehäuselager  
 Roulements et paliers auto-aligneurs gamme Self-Lube® et anti-corrosion Silver-Lube®  
 RHP Self-Lube® y Silver-Lube®  
 Supporti orientabili RHP Self-Lube® e supporti anticorrosione RHP Silver-Lube®  
 RHP Self-Lube® och Silver-Lube®

NSK	€	NSK	€
TSNP1	*	DNF155/12G	*
TSNP25DEC	*	DNF155/12AG	*
TSNP30	*	DNF155-50G	*
TSNP30DEC	*	DNF240/8	*
TSNP35	*	DNF240/9	*
TSNP35DEC	*	DNF240/9AG	*
TSNP40	*	DNF245/10G	*
TSNP40DEC	*	MP155/12	*
TSNP45	*	PDF155/12A	*
TSNP50	*	PDNF150-1.15/16	*
TSNP60	*	PDNF155/12A	*
TST30	*	PDNF245/10	*
TST30DEC	*	PDNF245/9A	*
TST35DEC	*	Silver Lube®	*
TST40	*	J1020-3/4GCR	*
TST45	*	J1025-1GCR	*
TST50	*	J1025-25GCR	*
		J1030-1.3/16GCR	*
		J1030-30GCR	*
		J1035-1.1/4GCR	*
Accessories		J1035-1.7/16GCR	*
Zubehör		J1035-35GCR	*
Accessoires		J1040-1.1/2GCR	*
Accesorios		J1040-40GCR	*
Accessori		PNP3/4CR	*
Tillbehör			
1017C	*	PNP1CR	*
40P	*	PNP1.3/16CR	*
55P	*	PNP1.1/4CR	*
60P	*	PNP1.1/2CR	*
1070C	*	PNP1.7/16CR	*
BTHFLA	*	PNP20CR	*
BTHFFLA	*	PNP25CR	*
Disc Harrow Bearings		PNP30CR	*
Scheibeneggenlager		PNP35CR	*
Roulements pour disque de charrue		PNP40CR	*
Rodamientos para Gradas de Disco		PSF3/4CR	*
Cuscineti per Erpici a Disco		PSF1CR	*
Skivharv lager		PSF1.3/16CR	*
DNF140-1.1/4G	*	PSF1.7/16CR	*
DNF155/12	*	PSF1.1/2CR	*

RHP Self-Lube® and Silver-Lube®  
 RHP Self-Lube® und Silver-Lube® Gehäuselager  
 Roulements et paliers auto-aligneurs gamme Self-Lube® et anti-corrosion Silver-Lube®  
 RHP Self-Lube® y Silver-Lube®  
 Supporti orientabili RHP Self-Lube® e supporti anticorrosione RHP Silver-Lube®  
 RHP Self-Lube® och Silver-Lube®

NSK	€	NSK	€
PSF20CR	*		
PSF25CR	*		
PSF30CR	*		
PSF35CR	*		
PSF40CR	*		
PSFT3/4CR	*		
PSFT1CR	*		
PSFT1.3/16CR	*		
PSFT1.1/4CR	*		
PSFT1.1/2CR	*		
PSFT1.7/16CR	*		
PSFT20CR	*		
PSFT25CR	*		
PSFT30CR	*		
PSFT35CR	*		
PSFT40CR	*		
PST3/4CR	*		
PST1CR	*		
PST1.3/16CR	*		
PST1.1/4CR	*		
PST1.1/2CR	*		
PST1.7/16CR	*		
PST20CR	*		
PST25CR	*		
PST30CR	*		
PST35CR	*		
PST40CR	*		
P25P	*		
P30P	*		
P40P	*		

**NSK Housed Bearings**

















**NSK-Gehäuselager**

**Roulements et paliers auto-aligneurs gamme NSK**

**Pillow Blocks de NSK**

**Supporti orientabili NSK**

**NSK kompletta lagerhus**

								
	<b>P200</b> <b>P300</b>	UCP200D1	UKP200D1+H	ASP200	AELP200	UELP200D1	UCP300D1	UKP300D1+H
	<b>UP200</b>	UCUP200				UELP200D1		
	<b>PP200</b>			ASPP200	AELPP200			
	<b>F200</b> <b>F300</b>	UCF200D1	UKF200D1+H	ASF200	AELF200	UELF200D1	UCF300D1	UKF300D1+H
	<b>FL200</b> <b>FL300</b>	UCFL200D1	UKFL200D1+H		AELF200	UELFL200D1	UCFL300D1	UKFL300D1+H
	<b>FC200</b>	UCFC200D1	UCFC200D1+H			UELFC200D1		
	<b>PF200</b>			ASPF200	AELPF200			
	<b>PFL200</b>			ASPFL200	AELPFL200			
	<b>T200</b> <b>T300</b>	UCT200D1	UKT200D1+H			UELT200D1	UCT300D1	UKT300D1+H
	<b>C200</b> <b>C300</b>	UCC200D1	UKC200D1				UCC300D1	UKC300D1+H

NSK Housed Bearings  
NSK-Gehäuselager  
Roulements et paliers auto-aligneurs gamme NSK  
Pillow Blocks de NSK  
Supporti orientabili NSK  
NSK kompletta lagerhus

NSK	€	NSK	€
Bearing Inserts		CS308LLU	91.99
Gehäuselagereinsätze		CS309LLU	145.42
Roulements de paliers		UC201D1	38.11
Insertos		UC202D1	38.11
Inserti Self-Lube®		UC202-010D1	40.96
Insatslager			
AEL201W3	37.86	UC203D1	38.11
AEL202W3	37.86	UC204D1	38.11
AEL203W3	37.86	UC204-012D1	40.96
AEL204W3	41.89	UC205D1	46.81
AEL205W3	45.44	UC205-014D1	50.32
AEL206W3	55.94	UC205-015D1	50.32
AEL206-104W3	60.19	UC206D1	53.83
AEL207W3	66.78	UC206-102D1	57.90
AEL208W3	77.72	UC206-103D1	57.90
AEL209W3	99.60	UC206-104D1	57.90
AEL210W3	109.00	UC207D1	64.67
AEL212W3	153.99	UC207-104D1	69.56
AS201	29.38	UC207-106D1	69.56
AS202	29.38	UC207-107D1	69.56
AS203	29.38	UC208D1	77.51
AS204	32.93	UC208-108D1	83.39
AS205	35.22	UC209D1	87.12
AS206	43.79	UC209-112D1	93.72
AS207	47.02	UC210D1	98.59
AS208	59.27	UC210-115D1	106.06
A-UCS205LD1	44.46	UC211D1	127.30
A-UCS206LD1	51.11	UC211-200D1	136.94
A-UCS207LD1	61.42	UC211-203D1	136.94
A-UCS212LD1	153.83	UC212D1	161.91
CS201LLU	21.66	UC212-204D1	174.18
CS202LLU	22.91	UC213D1	187.59
CS203LLU	24.68	UC214D1	244.52
CS204LLU	29.85	UC215D1	281.39
CS205LLU	34.96	UC216D1	335.01
CS206LLU	44.66	UC217D1	401.97
CS207LLU	59.77	UC218D1	515.92
CS208LLU	67.13	UC305D1	94.10
CS209LLU	80.15	UC306D1	112.20
CS210LLU	89.94	UC307D1	129.88
CS307LLU	88.75	UC308D1	157.09

NSK Housed Bearings  
NSK-Gehäuselager  
Roulements et paliers auto-aligneurs gamme NSK  
Pillow Blocks de NSK  
Supporti orientabili NSK  
NSK kompletta lagerhus

NSK	€	NSK	€
UC309D1	180.04	UK217D1	444.57
UC310D1	216.80	UK218D1	562.39
UC311D1	271.94	UK306D1	112.20
UC312D1	312.57	UK307D1	129.88
UC313D1	393.59	UK308D1	157.09
UC314D1	462.44	UK309D1	180.04
UC315D1	547.75	UK311D1	271.94
UC316D1	665.84	UK312D1	312.57
UC317D1	737.98	UK313D1	393.59
UC318D1	869.18	UK315D1	547.75
UC319D1	990.52	UK316D1	665.84
UC320D1	1328.31	UK317D1	737.98
UC322D1	1656.30	UK318D1	869.18
UC324D1	2240.12	UK319D1	990.52
UC326D1	3014.15	UK320D1	1328.31
UC328D1	3575.00		
UCX12D1	236.46		
UCX18D1	555.41		
UEL204D1W3	51.71		
UEL205D1W3	61.42		
UEL206D1W3	70.36		
UEL207D1W3	84.42		
UEL208D1W3	99.60		
UEL209D1W3	118.35		
UEL210D1W3	126.17		
UEL211D1W3	159.69		
UEL212D1W3	207.69		
UEL213D1W3	242.70		
UEL310D1W3	239.10		
UK205D1	45.56		
UK206D1	54.82		
UK207D1	68.12		
UK208D1	81.62		
UK209D1	94.37		
UK210D1	104.64		
UK211D1	133.99		
UK212D1	171.56		
UK213D1	203.03		
UK215D1	304.58		
UK216D1	376.90		



NSK Housed Bearings  
NSK-Gehäuselager  
Roulements et paliers auto-aligneurs gamme NSK  
Pillow Blocks de NSK  
Supporti orientabili NSK  
NSK kompletta lagerhus

NSK	€	NSK	€
Units		UCF203D1	58.86
Gehäuselagereinheiten		UCF204D1	57.16
Paliers		UCF205D1	66.36
Soportes con rodamiento NSK, Pillow Block		UCF206D1	79.61
Supporti orientabili NSK		UCF207D1	93.02
Kompletta enheter			
AELPF203W3	47.82	UCF208D1	112.77
AELPF204W3	52.74	UCF209D1	123.63
AELPF205W3	56.69	UCF210D1	146.41
AELPF206W3	67.95	UCF211D1	196.50
AELPF207W3	81.96	UCF212D1	236.72
AELPFL204W3	48.24	UCF213D1	290.32
AELPFL205W3	51.68	UCF214D1	351.73
ASPF202	36.64	UCF215D1	409.80
ASPF204	39.45	UCF216D1	489.07
ASPF205	42.60	UCF217D1	597.40
ASPF206	52.99	UCF218D1	739.22
ASPF207	61.38	UCF306D1	161.69
ASPFL201	36.73	UCF307D1	191.54
ASPFL202	36.73	UCF308D1	229.59
ASPFL203	36.73	UCF309D1	270.58
ASPFL204	40.11	UCF310D1	337.81
ASPFL205	43.08	UCF311D1	406.69
ASPFL206	52.49	UCF312D1	488.70
ASPP201	37.82	UCF313D1	560.86
ASPP202	37.82	UCF314D1	619.88
ASPP203	37.82	UCF315D1	790.42
ASPP204	42.60	UCF316D1	954.42
ASPP205	45.42	UCF317D1	1059.39
ASPP206	54.14	UCF318D1	1200.41
UCC204D1	71.55	UCF319D1	1387.36
UCC205D1	83.74	UCF320D1	1656.30
UCC206D1	101.53	UCF322D1	2240.12
UCC207D1	119.47	UCF324D1	3073.17
UCC208D1	129.51	UCF326D1	4066.98
UCC209D1	151.86	UCF328D1	4886.90
UCC210D1	171.97	UCFA203D1	74.76
UCC211D1	224.44	UCFA204D1	74.76
UCC212D1	271.32	UCFA205D1	87.50
UCF201D1	58.86	UCFA206D1	106.11
UCF202D1	58.86	UCFA207D1	124.85

NSK Housed Bearings  
NSK-Gehäuselager  
Roulements et paliers auto-aligneurs gamme NSK  
Pillow Blocks de NSK  
Supporti orientabili NSK  
NSK kompletta lagerhus

NSK	€	NSK	€
UCFA208D1	135.36	UCFL209D1	123.63
UCFA209D1	158.70	UCFL210D1	146.41
UCFA210D1	179.69	UCFL211D1	196.50
UCFA211D1	234.56	UCFL212D1	236.72
UCFC202D1	71.55	UCFL213D1	290.32
UCFC203D1	71.55	UCFL214D1	351.73
UCFC204D1	71.55	UCFL215D1	409.80
UCFC205D1	84.34	UCFL216D1	489.07
UCFC206D1	101.53	UCFL218D1	739.22
UCFC207D1	119.47	UCFL305D1	133.84
UCFC208D1	129.51	UCFL306D1	161.69
UCFC209D1	151.86	UCFL307D1	191.54
UCFC210D1	171.97	UCFL308D1	229.59
UCFC211D1	224.44	UCFL309D1	270.58
UCFC212D1	271.32	UCFL310D1	337.81
UCFC213D1	333.70	UCFS305D1	133.84
UCFC214D1	460.90	UCFS306D1	161.69
UCFC215D1	574.12	UCFS307D1	191.54
UCFC216D1	658.12	UCFS308D1	229.59
UCFC217D1	777.16	UCFS309D1	270.58
UCFC218D1	910.14	UCFS310D1	337.81
UCFH202D1	78.94	UCFS311D1	406.69
UCFH204D1	78.94	UCFS312D1	488.70
UCFH205D1	84.39	UCFS313D1	560.86
UCFH206D1	97.40	UCFS314D1	619.88
UCFH207D1	114.66	UCFS315D1	790.42
UCFH208D1	133.46	UCFS316D1	954.42
UCFH209D1	149.97	UCFS318D1	1200.41
UCFH210D1	184.51	UCFS320D1	1656.30
UCFL201D1	58.86	UCFS324D1	3073.17
UCFL202D1	58.86	UCFS326D1	4066.98
UCFL202-010D1	63.35	UCFX09D1	169.95
UCFL203D1	58.86	UCFX10D1	213.60
UCFL204D1	57.16	UCFX11D1	270.20
UCFL204-012D1	63.35	UCFX12D1	321.84
UCFL205D1	66.36	UCFX13D1	458.23
UCFL205-100D1	73.50	UCFX14D1	458.23
UCFL206D1	79.61	UCFX15D1	528.37
UCFL207D1	93.02	UCFX16D1	631.42
UCFL208D1	112.77	UCFX17D1	827.44

NSK Housed Bearings  
NSK-Gehäuselager  
Roulements et paliers auto-aligneurs gamme NSK  
Pillow Blocks de NSK  
Supporti orientabili NSK  
NSK kompletta lagerhus

NSK	€	NSK	€
UCFX18D1	827.44	UCP217D1	597.40
UCFX20D1	1241.03	UCP218D1	739.22
UCHB204D1	81.42	UCP305D1	133.84
UCHB205D1	92.90	UCP306D1	161.69
UCHB206D1	117.22	UCP307D1	191.54
UCHB207D1	137.78	UCP308D1	229.59
UCHB208D1	162.81	UCP309D1	270.58
UCHB209D1	169.10	UCP310D1	337.81
UCHB210D1	198.68	UCP311D1	406.69
UCHB211D1	233.77	UCP312D1	488.70
UCHB212D1	316.95	UCP313D1	560.86
UCHP204D1	64.02	UCP314D1	619.88
UCHP205D1	77.01	UCP315D1	790.42
UCHP206D1	90.39	UCP316D1	954.42
UCHP207D1	105.04	UCP317D1	1059.39
UCHP208D1	124.00	UCP318D1	1200.41
UCHP210D1	160.89	UCP320D1	1656.30
UCP201D1	58.86	UCP322D1	2240.12
UCP202D1	58.86	UCP324D1	3073.17
UCP202-010D1	63.35	UCP326D1	4066.98
UCP203D1	58.86	UCP328D1	4886.90
UCP204D1	57.16	UCPX09D1	169.95
UCP204-012D1	63.35	UCPX10D1	213.60
UCP205D1	66.36	UCPX11D1	270.20
UCP205-014D1	73.50	UCPX12D1	321.84
UCP205-100D1	73.50	UCPX13D1	331.36
UCP206D1	79.61	UCPX14D1	458.23
UCP207D1	93.02	UCPX15D1	528.37
UCP207-104D1	103.03	UCPX18D1	827.44
UCP208D1	112.77	UCPX20D1	1241.03
UCP208-108D1	124.92	UCT202D1	71.55
UCP209D1	123.63	UCT203D1	71.55
UCP210D1	146.41	UCT204D1	71.55
UCP211D1	196.50	UCT205D1	83.74
UCP211-200D1	211.42	UCT206D1	101.53
UCP212D1	236.72	UCT207D1	119.47
UCP213D1	290.32	UCT208D1	129.51
UCP214D1	351.73	UCT209D1	151.86
UCP215D1	409.80	UCT210D1	171.97
UCP216D1	489.07	UCT211D1	224.44

NSK Housed Bearings  
NSK-Gehäuselager  
Roulements et paliers auto-aligneurs gamme NSK  
Pillow Blocks de NSK  
Supporti orientabili NSK  
NSK kompletta lagerhus

NSK	€	NSK	€
UCT212D1	270.22	UELP204D1W3	80.07
UCT213D1	319.34	UELP205D1W3	92.46
UCT214D1	441.07	UELP206D1W3	112.80
UCT215D1	549.39	UELP207D1W3	131.75
UCT216D1	629.79	UELP208D1W3	140.72
UCT217D1	743.70	UELP209D1W3	164.17
UCT310D1	354.66	UELP210D1W3	188.70
UCT312D1	505.64	UELP211D1W3	232.26
UCT313D1	582.33	UELP212D1W3	297.54
UCT314D1	671.55	UELP311D1W3	449.59
UCT315D1	806.54	UELT208D1W3	147.41
UCT316D1	975.85	UELT210D1W3	198.76
UCT318D1	1269.86	UKC206D1	93.26
UCT320D1	1800.64	UKC207D1	108.51
UCTX16D1	1155.48	UKC208D1	126.02
UCUP201D1	84.83	UKC209D1	142.35
UCUP202D1	84.83	UKC210D1	165.70
UCUP203D1	84.83	UKC212D1	255.55
UCUP204D1	84.83	UKC213D1	310.39
UCUP205D1	97.81	UKF205D1	70.45
UCUP206D1	110.17	UKF206D1	86.20
UCUP207D1	138.87	UKF207D1	103.87
UCUP208D1	148.18	UKF208D1	120.59
UCUP209D1	169.19	UKF209D1	136.21
UCUP210D1	196.05	UKF210D1	158.57
UELF205D1W3	92.46	UKF211D1	199.86
UELF206D1W3	112.80	UKF212D1	255.55
UELF207D1W3	131.75	UKF213D1	310.39
UELF209D1W3	164.17	UKF215D1	446.91
UELF210D1W3	188.70	UKF216D1	529.74
UELF212D1W3	297.54	UKF217D1	634.80
UELFC206D1W3	118.35	UKF218D1	806.34
UELFC208D1W3	147.41	UKF308D1	229.59
UELFC209D1W3	173.05	UKF311D1	406.69
UELFC210D1W3	198.76	UKF312D1	488.70
UELFL205D1W3	92.46	UKF313D1	560.86
UELFL206D1W3	112.80	UKF315D1	790.42
UELFL207D1W3	131.75	UKF316D1	954.42
UELFL208D1W3	140.72	UKF317D1	1059.39
UELFL210D1W3	188.70	UKF318D1	1200.41

NSK Housed Bearings  
 NSK-Gehäuselager  
 Roulements et paliers auto-aligneurs gamme NSK  
 Pillow Blocks de NSK  
 Supporti orientabili NSK  
 NSK kompletta lagerhus

NSK	€	NSK	€
UKFC207D1	122.51	UKT206D1	95.06
UKFC208D1	144.73	UKT207D1	111.63
UKFC209D1	168.06	UKT208D1	123.92
UKFC210D1	186.71	UKT209D1	144.02
UKFC211D1	232.22	UKT210D1	168.59
UKFC212D1	291.71	UKT211D1	212.15
UKFC213D1	340.71	UKT212D1	254.59
UKFC215D1	579.95	UKT213D1	324.37
UKFC216D1	651.13	UKT215D1	490.09
UKFC218D1	889.18	UKT216D1	600.95
UKFL205D1	70.45	Z-UCF207D1	126.02
UKFL206D1	86.20	Z-UCF208D1	147.04
UKFL207D1	103.87	Z-UCF210D1	193.69
UKFL208D1	120.59	Z-UCFC207D1	126.02
UKFL209D1	136.21	Z-UCFC208D1	155.21
UKFL210D1	158.57	Z-UCFC209D1	170.35
UKFL211D1	199.86	Z-UCFL204D1	77.84
UKFL212D1	255.55	Z-UCFL208D1	147.04
UKFL213D1	310.39	Z-UCP205D1	95.21
UKP205D1	70.45	Z-UCP207D1	129.51
UKP206D1	86.20	Z-UCP208D1	156.35
UKP207D1	103.87	Z-UCP209D1	176.17
UKP208D1	120.59		
UKP209D1	136.21		
UKP210D1	158.57		
UKP211D1	199.86		
UKP212D1	255.55		
UKP213D1	310.39		
UKP215D1	446.91		
UKP216D1	529.74		
UKP217D1	634.80		
UKP218D1	806.34		
UKP306D1	161.69		
UKP307D1	191.54		
UKP309D1	274.57		
UKP310D1	337.81		
UKP311D1	406.69		
UKP312D1	488.70		
UKP313D1	560.86		
UKP316D1	954.42		



## **Plummer Blocks**

## **Stehlagergehäuse**

## **Paliers en deux parties**

## **Soportes Partidos (Plummer Blocks)**

## **Supporti ritti in due metà**

## **Stålagerhus**

The C, V, G seals are supplied by pair, to equip both sides of the housing. Locating rings are also supplied by pair, to equip 1 fixed end housing. It is identified with the suffix KIT on part number.

C, V und G – Dichtungen werden paarweise geliefert zur beidseitigen Abdichtung eines Gehäuses. Festringe kommen ebenfalls paarweise zur Fixierung eines Lagers als Festlager. Dies wird mit dem Zusatz KIT in der Bestellnr. gekennzeichnet.

Les joints C, V, G sont fournis par paire, afin d'équiper les deux faces du corps de palier. Les bagues d'arrêt sont également fournies par paire, afin d'équiper un palier fixe. Dans la référence, le suffixe KIT correspond à une fourniture par paire.

Los sellados tipos C, V y G, son suministrados por pares para ambos lados del alojamiento. Los anillos de fijación también se suministran por pares para fijar axialmente en el soporte. Se identifican con el sufijo KIT en la nomenclatura.

Le tenute C, V, G vengono fornite in coppia per consentire la protezione di entrambi i lati dell'alloggiamento. Lo stesso vale per gli anelli di ancoraggio che si applicano all'alloggiamento con supporto bloccato. Quest'ultimo viene identificato dal suffisso KIT.

C, V, G tätningar levereras i par, för montering på båda sidor av huset. Avståndsringar levereras även i par, för montering av "fixed end". De identifieras med suffixet KIT på artikelnummer.

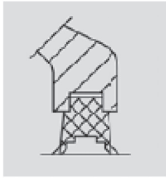
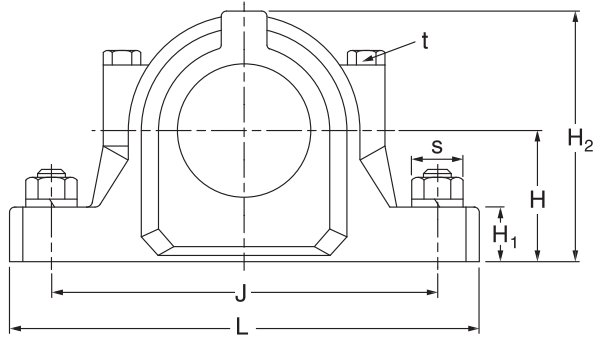

**G Seals**

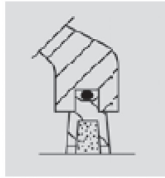

**C Seals**



**V Seals**

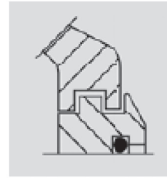

**TS-U Seals**

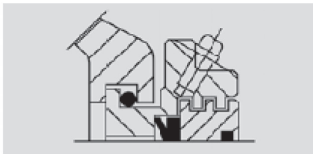

**TACK Seals**



Plummer Blocks  
 Stehlagergehäuse  
 Paliers en deux parties  
 Soportes Partidos (Plummer Blocks)  
 Supporti ritti in due metà  
 Stålagerhus

NSK	RHP	€	NSK	RHP	€
SNN506-605		150.63	516A		15.60
SNN507-606		111.83	517A		16.19
SNN508-607		113.03	518A		18.48
SNN509		119.01	519A		23.15
SNN510-608		128.35	520A		25.11
SNN511-609		180.95	522A		27.72
SNN512-610		197.04	524A		36.63
SNN513-611		230.51	526A		39.67
SNN515-612		243.55	528A		54.12
SNN516-613		302.79	530A		57.17
SNN517		336.91	532A		76.08
SNN518-615		384.95	TS34		223.77
SNN519-616		445.59	TS36		234.56
SNN520-617		537.42	TS38		246.14
SNN522-619		695.33	TS40		261.49
SNN524-620		913.89	TS44		279.67
SNN526		1048.98	TS48		394.46
SNN528		1287.86	TS52		414.01
SNN530		1575.86	TS56		624.60
SNN532		1952.22	TS60		660.11
-	SD3134	2882.97	TS64		666.18
-	SD3136	3367.80	TS505U		359.74
-	SD3138	3903.93	TS506U		159.33
-	SD3140	4953.97	TS507U		121.94
-	SD3144	5326.03	TS508U		130.52
-	SD3148	7154.67	TS509U		129.12
-	SD3152	9159.59	TS510U		131.18
-	SD3156	10218.23	TS511U		132.15
-	SD3160	11522.92	TS512U		156.40
-	SD3164	13701.78	TS513U		137.48
505A		8.15	TS515U		146.17
506A		8.15	TS516U		147.15
507A		8.59	TS517U		156.28
508A		9.45	TS518U		218.02
509A		9.79	TS519U		307.02
510A		10.16	TS520U		266.05
511A		10.55	TS522U		285.50
512A		11.63	TS524U		322.02
513A		12.33	TS526U		382.23
515A		13.36	TS528U		391.25

Plummer Blocks  
 Stehlagergehäuse  
 Paliers en deux parties  
 Soportes Partidos (Plummer Blocks)  
 Supporti ritti in due metà  
 Stålagerhus

NSK	RHP	€	NSK	RHP	€
TS530U		424.51	TACK508		273.00
TS532U		450.48	TACK509		273.00
TS605U		358.10	TACK510		286.37
TS606U		361.47	TACK511		298.44
TS607U		364.29	TACK512		310.82
TS608U		333.43	TACK513		324.52
TS609U		377.77	TACK515		339.08
TS610U		405.59	TACK516		376.91
TS611U		441.78	TACK517		382.66
TS612U		493.73	TACK518		463.30
TS613U		443.74	TACK519		530.90
TS615U		616.32	TACK520		535.03
TS616U		744.24	TACK522		610.78
TS617U		567.63	TACK524		705.76
TS619U		672.62	TACK526		820.10
TS620U		678.60	TACK528		958.78
TSA34		223.77	TACK530		1180.26
TSA36		234.56	TACK532		1248.19
TSA38		246.14	TACK605		273.00
TSA40		261.49	TACK606		273.00
TSA44		279.67	TACK607		273.00
TSA48		394.46	TACK608		286.37
TSA52		414.01	TACK609		298.32
TSA56		624.60	TACK610		310.82
TSA60		660.11	TACK611		324.52
TSA64		666.18	TACK612		339.08
TSA68		969.81	TACK613		376.91
TSA72		1725.20	TACK615		463.30
TSA76		2007.26	TACK616		530.90
TSA80		2653.23	TACK617		530.90
-	TSM34	221.87	TACK619		610.78
-	TSM36	232.71	TACK620		705.76
-	TSM40	259.10	C505-KIT		64.99
-	TSM44	277.51	C506-KIT		64.99
-	TSM48	391.28	C507-KIT		64.99
-	TSM52	411.31	C508-KIT		66.94
-	TSM56	619.22	C509-KIT		70.21
-	TSM60	654.53	C510-KIT		73.47
TACK506		273.00	C511-KIT		75.54
TACK507		273.00	C512-KIT		80.32

Plummer Blocks  
 Stehlagergehäuse  
 Paliers en deux parties  
 Soportes Partidos (Plummer Blocks)  
 Supporti ritti in due metà  
 Stålagerhus

NSK	RHP	€	NSK	RHP	€
C513-KIT		81.30	G522-KIT		65.53
C515-KIT		96.29	G524-KIT		53.14
C516-KIT		105.85	G526-KIT		58.42
C517-KIT		109.34	G528-KIT		64.77
C518-KIT		125.75	G530-KIT		79.55
C519-KIT		154.43	G532-KIT		97.59
C520-KIT		158.02	G607-KIT		21.41
C522-KIT		164.32	G608-KIT		25.00
C524-KIT		171.82	G609-KIT		29.78
C526-KIT		178.24	G610-KIT		21.74
C528-KIT		181.39	G611-KIT		23.15
C530-KIT		185.30	G612-KIT		24.23
C532-KIT		203.44	G613-KIT		25.65
C605-KIT		64.99	G615-KIT		31.52
C606-KIT		64.99	G616-KIT		40.00
C607-KIT		66.94	G617-KIT		44.77
C608-KIT		75.86	G619-KIT		54.12
C609-KIT		79.34	G620-KIT		58.91
C610-KIT		82.16	V505-KIT		30.43
C611-KIT		83.90	V506-KIT		31.41
C612-KIT		96.29	V507-KIT		35.76
C613-KIT		105.85	V508-KIT		30.43
C615-KIT		125.63	V509-KIT		38.58
C616-KIT		131.61	V510-KIT		39.34
C617-KIT		146.17	V511-KIT		44.13
C619-KIT		184.54	V512-KIT		51.08
C620-KIT		197.48	V513-KIT		52.71
G507-KIT		21.41	V515-KIT		58.15
G508-KIT		23.04	V516-KIT		60.21
G509-KIT		19.34	V517-KIT		62.93
G510-KIT		20.54	V518-KIT		69.01
G511-KIT		26.08	V519-KIT		74.56
G512-KIT		23.91	V520-KIT		74.88
G513-KIT		24.67	V522-KIT		78.57
G515-KIT		30.21	V524-KIT		94.56
G516-KIT		33.70	V526-KIT		109.88
G517-KIT		36.30	V528-KIT		126.61
G518-KIT		41.74	V530-KIT		166.29
G519-KIT		52.27	V532-KIT		183.02
G520-KIT		60.21	V605-KIT		32.06

Plummer Blocks  
 Stehlagergehäuse  
 Paliers en deux parties  
 Soportes Partidos (Plummer Blocks)  
 Supporti rititi in due metà  
 Stålagerhus

NSK	RHP	€	NSK	RHP	€
V606-KIT		29.02	SR170/5-KIT		36.51
V607-KIT		31.63	SR180/12-KIT		46.40
V608-KIT		38.25	SR180/14.5-KIT		57.39
V609-KIT		38.25	SR180/18-KIT		66.08
V610-KIT		42.39	SR180/4.75-KIT		39.45
V611-KIT		43.04	SR180/5-KIT		39.45
V612-KIT		51.29	SR200/13.5-KIT		74.66
V613-KIT		51.73	SR200/17.5-KIT		91.51
V615-KIT		54.24	SR200/21-KIT		90.10
V616-KIT		74.12	SR200/5-KIT		49.99
V617-KIT		79.12	SR200/6.5-KIT		49.99
V619-KIT		84.55	SR215/14-KIT		65.43
V620-KIT		101.62	SR215/19.5-KIT		107.48
SR100/11.5-KIT		23.91	SR215/5-KIT		48.36
SR100/4-KIT		19.56	SR215/6.5-KIT		56.84
SR100/9.5-KIT		20.44	SR230/13-KIT		76.51
SR110/10.5-KIT		22.06	SR230/5-KIT		60.42
SR110/10-KIT		23.25	SR250/15-KIT		94.66
SR110/13-KIT		28.26	SR250/5-KIT		67.70
SR110/4-KIT		21.52	SR270/16.5-KIT		141.07
SR120/10-KIT		24.01	SR270/5-KIT		99.23
SR120/11-KIT		26.08	SR290/17-KIT		191.28
SR120/14-KIT		31.09	SR290/5-KIT		131.29
SR120/4-KIT		24.01	SR52/3.5-KIT		15.22
SR130/12.5-KIT		32.39	SR52/5-KIT		15.22
SR130/15.5-KIT		34.67	SR62/4-KIT		16.31
SR130/5-KIT		26.08	SR62/6-KIT		15.22
SR140/12.5-KIT		32.39	SR62/7.5-KIT		15.22
SR140/16-KIT		34.67	SR62/8-KIT		15.22
SR140/5-KIT		27.38	SR72/3.5-KIT		21.74
SR150/12.5-KIT		31.73	SR72/5.5-KIT		18.15
SR150/16.5-KIT		36.73	SR72/7.5-KIT		17.17
SR160/12.5-KIT		35.00	SR72/8.5-KIT		17.17
SR160/14-KIT		41.95	SR80/10.5-KIT		19.56
SR160/17.5-KIT		49.99	SR80/4-KIT		17.17
SR160/5-KIT		34.67	SR80/8-KIT		18.15
SR160/6.25-KIT		34.67	SR80/9-KIT		18.15
SR170/12.5-KIT		50.65	SR85/3.5-KIT		16.73
SR170/14.5-KIT		52.71	SR85/5.5-KIT		17.17
SR170/18-KIT		55.75	SR90/10.5-KIT		21.20

Plummer Blocks  
Stehlagergehäuse  
Paliers en deux parties  
Soportes Partidos (Plummer Blocks)  
Supporti ritti in due metà  
Stålagerhus

NSK	RHP	€	NSK	RHP	€
SR90/4-KIT		18.15			
SR90/9-KIT		19.56			



**Accessories**

**Zubehör**

**Accessoires**

**Accesorios**

**Accessori**

**Tillbehör**

**NSK**Accessories  
Zubehör  
Accessoires  
Accesorios  
Accessori  
Tillbehör

<b>NSK</b>	<b>€</b>	<b>NSK</b>	<b>€</b>
AH308	95.40	AHX2317	170.19
AH309	96.87	AHX2318	174.16
AH313	114.06	AHX2319	216.33
AH314	116.70	AHX2320	217.79
AH315	122.38	AHX2322	280.06
AH316	154.30	AHX2324	315.24
AH2308	100.19	AHX2326	366.06
AH2309	103.56	AHX2328	536.01
AH2313	130.07	AHX2330	640.64
AH2322	488.53	AHX3024	219.96
AH2332	869.77	AHX3028	328.21
AH2334	963.18	AHX3122	261.87
AH2336	1078.23	AHX3124	296.63
AH2338	1344.78	AHX3126	325.69
AH2340	1438.17	AHX3128	423.94
AH3034	485.32	AHX3130	503.72
AH3132	646.45	AHX3218	167.71
AH3134	640.64	AHX3220	211.18
AH3136	819.12	AHX3222	255.49
AH3138	931.32	AHX3224	320.90
AH3140	1045.76	AHX3226	351.54
AH3152	2844.28	AHX3228	440.81
AH3232	808.73	AHX3230	614.96
AH3236	1027.97	AN01	5.31
AH3240	1349.00	AN02	5.90
AHX310	98.72	AN03	7.38
AHX311	107.88	AN04	9.83
AHX312	109.54	AN05	10.45
AHX313	114.37	AN06	11.30
AHX317	135.44	AN07	12.97
AHX318	141.55	AN08	13.23
AHX319	159.04	AN09	14.01
AHX320	175.84	AN10	16.24
AHX2310	108.20	AN11	17.54
AHX2311	113.29	AN12	19.01
AHX2312	115.61	AN13	22.95
AHX2313	130.02	AN14	26.50
AHX2314	112.02	AN15	28.28
AHX2315	142.15	AN16	38.22
AHX2316	135.31	AN17	46.97



**NSK**

Accessories  
Zubehör  
Accessoires  
Accesorios  
Accessori  
Tillbehör

<b>NSK</b>	<b>€</b>	<b>NSK</b>	<b>€</b>
AN18	54.84	AW24	18.28
AN19	59.58	AW25	24.45
AN20	66.53	AW26	25.36
AN21	71.70	AW27	30.16
AN22	86.90	AW28	28.59
AN23	123.23	AW29	32.98
AN24	100.22	AW30	33.72
AN25	142.81	AW36	56.57
AN26	126.07	AW40	70.00
AN27	194.58	H205	23.49
AN28	158.20	H206	23.75
AN29	227.72	H208	26.57
AN30	184.06	H209	32.57
AN32	205.23	H211	37.78
AN36	263.55	H212	41.28
AN40	320.76	H213	44.29
AN56	869.37	H214	45.03
AW01	1.35	H215	78.03
AW02	1.24	H216	93.86
AW03	1.24	H217	106.55
AW04	1.42	H218	122.72
AW05	1.42	H219	148.91
AW06	1.42	H220	154.86
AW07	1.42	H222	193.96
AW08	1.71	H2304	30.36
AW09	1.74	H2305	36.31
AW10	1.98	H2308	37.18
AW11	2.45	H2310	46.12
AW12	2.66	H2311	50.52
AW13	2.90	H2312	67.28
AW14	3.29	H2314	99.69
AW15	3.38	H2315	104.54
AW16	4.64	H2316	124.91
AW17	5.17	H2317	133.12
AW18	6.48	H2318	165.14
AW19	7.52	H2319	205.65
AW20	8.93	H2320	225.09
AW21	9.58	H2322	262.21
AW22	9.77	H2324	360.42
AW23	12.40	H2326	488.31

**NSK**

Accessories  
Zubehör  
Accessoires  
Accesorios  
Accessori  
Tillbehör

<b>NSK</b>	<b>€</b>	<b>NSK</b>	<b>€</b>
H2328	574.37	H3130	572.02
H2330	743.23	H3132	669.23
H2332	833.42	H3134	720.48
H2334	1096.40	H3136	859.99
H2336	1123.21	H3138	989.43
H2338	1612.30	H3140	1157.17
H2340	1646.59	H3144	1879.49
H2344	2384.09	H3148	2108.69
H2348	2872.51	H3152	2597.10
H2352	4465.27	H3156	3216.36
H306	24.31	H3160	3722.40
H308	28.92	H3164	6281.52
H309	33.42	HE205	30.61
H310	37.78	HE206	34.41
H311	39.54	HE208	36.88
H312	41.96	HE209	43.24
H313	46.80	HE210	48.56
H314	77.30	HE211	52.91
H317	113.30	HE213	61.56
H319	146.14	HE215	108.37
H320	163.62	HE216	128.06
H322	206.10	HE217	131.40
H3024	247.55	HE2306	44.32
H3026	304.42	HE2308	51.68
H3028	405.81	HE2309	59.98
H3030	558.85	HE2310	60.88
H3032	598.65	HE2313	107.40
H3034	689.83	HE2315	145.39
H3036	857.30	HE2316	158.88
H3038	944.63	HE2317	172.25
H3040	1188.00	HE2320	310.58
H3044	1625.15	HE2322	359.02
H3048	1987.05	HE2326	499.12
H3064	4284.02	HE309	49.85
H3068	5786.23	HE310	50.62
H3120	256.19	HE311	54.21
H3122	249.53	HE313	65.67
H3124	248.36	HE315	103.51
H3126	321.67	HE316	133.95
H3128	414.49	HE317	142.11

---

**NSK**

Accessories  
Zubehör  
Accessoires  
Accesorios  
Accessori  
Tillbehör

NSK	€	NSK	€
HE318	167.79		
HE320	215.57		
HE322	263.20		
HE3124	351.30		
HE3126	351.30		
HE3128	380.10		
HE3130	640.31		
HE3132	658.38		



## **Precision Machine Components**

NSK	€	NSK	€
<b>L H SERIES SCHIENEN  </b> <b>RAILS   ROTAIE  </b> <b>RAILES   RAILS</b>  <b>Schiene Standard</b> <b>Rails standard</b> <b>Rotaie standard</b> <b>Railes estándar</b> <b>Rails standard</b>		<b>Schiene schwarz verchromt</b> <b>Rails coated black chrome</b> <b>Rotaie con trattamento</b> <b>romo negro</b> <b>Railes cromado en negro</b> <b>Rails traités chromage noir</b>	
L1H152980LCW-02PCZ	1278.04	L1H151980LDNB01PCZ	1041.64
L1H203960LCW-02PCZ	1849.54	L1H203960-21Z	2404.40
L1H253960LCW-02PCZ	1865.76	L1H253960-21Z	2425.49
L1H304000LCW-02PCZ	1926.11	L1H304000-21Z	2503.96
L1H354000LCW-02PCZ	2028.98	L1H353040-21Z	3060.80
L1H453990LCW-02PCZ	2603.36	L1H453045-21Z	3227.90
L1H553960LCNGZZ	3354.04	L1H553000-21Z	4106.51
L1H653900LCNGZZ	4316.43	L1H653900-21Z	6284.34
<b>PH-Schiene</b> <b>PH-Standard Rails</b> <b>PH-standard Rotaie</b> <b>PH-standard Railes estándar</b> <b>PH-Rails standard</b>		<b>Schiene rostarm</b> <b>Rails stainless</b> <b>Rotaie INOX</b> <b>Railes inoxidable</b> <b>Rails acier inoxydable</b>	
L1H152980LCW-01PHZ	1703.62	L1H151780LKNGZZ	1260.56
L1H203960LCW-01PHZ	2465.43	L1H203460LKNGZZ	2828.02
L1H253960LCW-01PHZ	2487.07	L1H253460LKNGZZ	2852.82
L1H304000LCW-01PHZ	2567.51	L1H303480-SZ	2932.50
L1H354000LCW-01PHZ	2704.61		
L1H453990LCW-01PHZ	3470.27		
<b>Schiene von unten</b> <b>verschraubbar</b> <b>Rails bottom hole mounting</b> <b>Rotaie foratura da sotto</b> <b>Railes montaje roscado</b> <b>inferior</b> <b>Rails montage par le dessous</b>		<b>LH SERIES</b> <b>FUHRUNGSWAGEN  </b> <b>CARRIAGES   PATTINI  </b> <b>PATINES   PATINS</b>  <b>Standard</b> <b>Standard</b> <b>Standard</b> <b>Estándar</b> <b>Standard</b>	
L1H151980LVNG01PCZ	1041.64	LAH15ANZ	119.01
L1H203960LVNG01PCZ	2404.40	LAH15BNZ	140.75
L1H253960LVNG01PCZ	2425.49	LAH15EMZ	125.88
L1H304000LVNG01PCZ	2503.96	LAH15GMZ	147.62
L1H354000LVNG01PCZ	2637.66	LAH20ANZ	141.90
L1H453990LVNG01PCZ	3411.31	LAH20BNZ	170.51
L1H553960LVNG01PCZ	4404.24	LAH20BMZ	170.51
		LAH20EMZ	146.47
		LAH20GMZ	175.07
		LAH25ALZ	161.36
		LAH25ANZ	161.36
		LAH25BLZ	197.96
		LAH25BNZ	197.96
		LAH25EMZ	167.08

LINEARFÜHRUNG  
LINEAR GUIDES  
GUIDE  
GUIAS LINEALES  
GUIDAGES LINÉAIRES

NSK	€	NSK	€
LAH25GMZ	204.84	LAH30EMZ-K	214.71
LAH30ALZ	175.07	LAH30GMZ-K	257.06
LAH30ANZ	175.07	LAH35ANZ-K	225.00
LAH30BLZ	216.28	LAH35BNZ-K	279.94
LAH30BNZ	216.28	LAH35EMZ-K	235.31
LAH30EMZ	187.67	LAH35GMZ-K	290.23
LAH30GMZ	230.02	LAH45ANZ-K	341.42
LAH35ALZ	197.96	LAH45BNZ-K	418.09
LAH35ANZ	197.96	LAH45EMZ-K	352.86
LAH35BLZ	252.90	LAH45GMZ-K	432.96
LAH35BNZ	252.90	LAH55ANZ-K	546.63
LAH35EMZ	208.27	LAH55BNZ-K	669.99
LAH35GMZ	263.19	LAH55EMZ-K	578.10
LAH45ANZ	308.97	LAH55GMZ-K	707.75
LAH45BNZ	385.64	LAH65ANZ-K	837.70
LAH45EMZ	320.41	LAH65BNZ-K	1033.26
LAH45GMZ	400.51	LAH65EMZ-K	911.50
LAH55ANZ	487.16	LAH65GMZ-K	1091.17
LAH55BNZ	610.50		
LAH55EMZ	518.62	<b>Mit erhöhter Vorspannung</b>	
LAH55GMZ	648.26	<b>Higher preload</b>	
LAH65ANZ	767.40	<b>Precarico alto</b>	
LAH65BNZ	962.96	<b>Con precarga Alta</b>	
LAH65EMZ	841.19	<b>Forte précharge</b>	
LAH65GMZ	1020.86	LAH15ANH	119.01
		LAH15BNH	140.75
<b>Mit K1 montiert</b>		LAH15EMH	125.88
<b>With K1</b>		LAH15GMH	147.62
<b>Con K1</b>		LAH20ANH	141.90
<b>Con K1</b>		LAH20BNH	170.51
<b>Avec K1</b>		LAH20EMH	146.47
LAH15ANZ-K	138.48	LAH20GMH	175.07
LAH15BNZ-K	160.22	LAH25ALH	161.36
LAH15EMZ-K	145.35	LAH25ANH	161.36
LAH15GMZ-K	167.09	LAH25BLH	197.96
LAH20ANZ-K	163.53	LAH25BNH	197.96
LAH20BNZ-K	192.14	LAH25EMH	167.08
LAH20EMZ-K	168.11	LAH25GMH	204.84
LAH20GMZ-K	196.71	LAH30ANH	175.07
LAH25ALZ-K	182.99	LAH30BNH	216.28
LAH25ANZ-K	182.99	LAH30EMH	187.67
LAH25BNZ-K	219.60	LAH30GMH	230.02
LAH25EMZ-K	188.71	LAH35ALH	197.96
LAH25GMZ-K	226.47	LAH35ANH	197.96
LAH30ALZ-K	202.11	LAH35BNH	252.90
LAH30ANZ-K	202.11	LAH35EMH	208.27
LAH30BLZ-K	243.32	LAH35GMH	263.19
LAH30BNZ-K	243.32	LAH45ANH	308.97

NSK	€	NSK	€
LAH45BNH	385.64	LAH25ANZ-F	209.76
LAH45EMH	320.41	LAH25BLZ-F	257.36
LAH45GMH	400.51	LAH25BNZ-F	257.36
LAH55BNH	610.50	LAH25EMZ-F	217.19
LAH55GMH	648.26	LAH25GMZ-F	266.28
<b>Mit erhöhter Vorspannung und K1</b>		LAH30ANZ-F	227.60
<b>Higher preload and K1</b>		LAH30BNZ-F	281.16
<b>Preacarico alto e K1</b>		LAH30EMZ-F	243.97
<b>Con precarga alta y K1</b>		LAH30GMZ-F	299.02
<b>Forte précharge et K1</b>		LAH35ANZ-F	257.36
LAH15ANH-K	138.48	LAH35BNZ-F	328.76
LAH15EMH-K	145.35	LAH35EMZ-F	270.75
LAH20ANH-K	163.53	LAH35GMZ-F	342.16
LAH20BNH-K	192.14	LAH45ANZ-F	401.66
LAH20EMH-K	168.11	LAH45EMZ-F	416.54
LAH20GMH-K	196.71	LAH45GMZ-F	520.68
LAH25ALH-K	182.99	LAH55ANZ-F	633.29
LAH25ANH-K	182.99	LAH55BNZ-F	793.66
LAH25BNH-K	219.60	LAH55EMZ-F	674.20
LAH25EMH-K	188.71	LAH55GMZ-F	842.74
LAH25GMH-K	226.47	LAH65ANZ-F	997.61
LAH30ANH-K	202.11	LAH65BNZ-F	1251.85
LAH30BNH-K	243.32	LAH65EMZ-F	1093.56
LAH30EMH-K	214.71	LAH65GMZ-F	1327.12
LAH30GMH-K	257.06	<b>Rostarm</b>	
LAH35ANH-K	225.00	<b>Stainless</b>	
LAH35BNH-K	279.94	<b>INOX</b>	
LAH35EMH-K	235.31	<b>Inoxidable</b>	
LAH35GMH-K	290.23	<b>Acier inoxydable</b>	
LAH45ANH-K	341.42	LAH15ANSZ	208.26
LAH45BNH-K	418.09	LAH15BNSZ	246.31
LAH45EMH-K	352.86	LAH15EMSZ	220.28
LAH45GMH-K	432.96	LAH15GMSZ	258.33
<b>Schwarz verchromt</b>		LAH20ANSZ	248.32
<b>Coated black chrome</b>		LAH20BNSZ	298.38
<b>Con cromatura a bassa temperatura</b>		LAH20EMSZ	256.32
<b>Con cromado negro</b>		LAH20GMSZ	306.38
<b>Par chromage noir à basse température</b>		LAH20GMSZ	306.38
LAH15EMZ-F	163.64	LAH25ANSZ	282.37
LAH20ANZ-F	184.46	LAH25BNSZ	346.43
LAH20BNZ-F	221.66	LAH25EMSZ	292.39
LAH20EMZ-F	190.41	LAH25GMSZ	358.46
LAH20GMZ-F	227.60	LAH30ANSZ	306.38
		LAH30BNSZ	378.49
		LAH30EMSZ	328.42
		LAH30GMSZ	402.52



NSK	€	NSK	€
<b>S1-SERIES</b>		SAH20ANZ-K	184.81
<b>FUHRUNGSWAGEN  </b>		SAH20BNZ-K	217.71
<b>CARRIAGES   PATTINI  </b>		SAH20EMZ-K	190.07
<b>PATINES   PATINS</b>		SAH20GMZ-K	222.98
<b>SH Standard</b>		SAH25ALZ-K	207.19
<b>SH Standard</b>		SAH25ANZ-K	207.19
<b>SH Standard</b>		SAH25BLZ-K	249.29
<b>SH Estándar</b>		SAH25BNZ-K	249.29
<b>SH Standard</b>		SAH25EMZ-K	213.77
SAH15ANZ	136.85	SAH25GMZ-K	257.19
SAH15BNZ	161.87	SAH30ALZ-K	228.38
SAH15EMZ	144.76	SAH30ANZ-K	228.38
SAH15GMZ	169.76	SAH30BLZ-K	275.76
SAH20ANZ	163.18	SAH30BNZ-K	275.76
SAH20BNZ	196.08	SAH30GMZ-K	291.55
SAH20EMZ	168.44	SAH30GMZ-K	291.55
SAH20GMZ	201.34	SAH35ALZ-K	254.70
SAH25ALZ	185.56	SAH35ANZ-K	254.70
SAH25ANZ	185.56	SAH35BLZ-K	317.88
SAH25BLZ	227.66	SAH35BNZ-K	317.88
SAH25BNZ	227.66	SAH35EMZ-K	266.55
SAH25EMZ	192.14	SAH35GMZ-K	329.71
SAH25GMZ	235.56		
SAH30ALZ	201.34		
SAH30ANZ	201.34		
SAH30BLZ	248.72		
SAH30BNZ	248.72		
SAH30EMZ	215.82		
SAH30GMZ	264.51		
SAH35ALZ	227.66		
SAH35ANZ	227.66		
SAH35BLZ	290.84		
SAH35BNZ	290.84		
SAH35EMZ	239.51		
SAH35GMZ	302.67		
SAH45EMZ	368.47		
SAH45GMZ	460.60		
<b>SH mit K1 montiert</b>			
<b>SH with K1</b>			
<b>SH con K1</b>			
<b>SH con K1</b>			
<b>SH avec K1</b>			
SAH15ANZ-K	156.33		
SAH15BNZ-K	181.33		
SAH15EMZ-K	164.23		

NSK	€	NSK	€
<b>ZUBEHÖR FÜR LINEARFÜHRUNGEN LH SERIE   ACCESSORIES FOR LINEAR GUIDES LH SERIES   ACCESSORI PER GUIDE SERIE LH   ACCESORIOS PARA GUÍAS LINEALES DE LA SERIE LH   ACCESSOIRES POUR GUIDAGES LINÉAIRES SERIE LH</b>		<b>Gummiabstreifer Seals Guarnizioni Sellados de goma Joints</b>	
<b>Kunststoffstopfen Plastic caps Tappi in plastica Tapones de plástico Capuchons de trous de fixation</b>		LH15WS-01	7.13
LG-CAP/M04-500P	468.00	LH15WSC-01	25.64
LG-CAP/M05-500P	478.40	LH20WS-01	9.09
LG-CAP/M06-500P	478.40	LH20WSC-01	25.64
LG-CAP/M08-500P	608.40	LH25WS-01	9.73
LG-CAP/M12-500P	654.16	LH25WSC-01	25.85
LG-CAP/M14-50P	70.20	LH30WS-01	10.38
LG-CAP/M16-50P	70.20	LH30WSC-01	26.94
<b>K1 Schmiereinheit K1 lubrication unit Unità di lubrificazione K1 Unidad de lubricación K1 Unité de lubrification K1</b>		LH35WS-01	11.03
LH15K1/KIT	45.95	LH35WSC-01	27.36
LH20K1/KIT	70.95	LH45WS-01	15.25
LH25K1/KIT	74.53	LH45WSC-01	34.51
LH30K1/KIT	78.09	LH55WS-01	20.01
LH35K1/KIT	85.12	LH55WSC-01	38.50
LH45K1/KIT	125.36	LH65WS-01	25.85
LH55K1/KIT	145.37	<b>Stahlabstreifer Protectors Protectors Protectores metálicos Protecteurs</b>	
LH65K1/KIT	151.32	LH15PT-01	8.22
		LH15PTC-01	25.85
		LH20PT-01	9.41
		LH20PTC-01	25.85
		LH25PT-01	10.92
		LH25PTC-01	27.14
		LH30PT-01	12.88
		LH30PTC-01	29.31
		LH35PT-01	13.52
		LH35PTC-01	30.07
		LH45PT-01	15.46
		LH45PTC-01	34.61
		LH55PT-01	50.84
		LH55PTC-01	69.33
		LH65PT-01	60.03
		LH65PTC-01	78.52

NSK	€	NSK	€
<b>LS SERIES SCHIENEN   RAILS   ROTAIE   RAILES   RAILS</b>		<b>LS SERIES FUHRUNGSWAGEN   CARRIAGES   PATTINI   PATINES   PATINS</b>	
<b>Schienen Standard</b>		<b>Standard</b>	
<b>Rails standard</b>		<b>Standard</b>	
<b>Rotaie standard</b>		<b>Standard</b>	
<b>Railes estándar</b>		<b>Estándar</b>	
<b>Rails standard</b>		<b>Standard</b>	
L1S152920LCW-02PCZ	1040.23	LAS15ALZ	108.71
L1S152920TCW-02PCZ	1040.23	LAS15CLZ	90.40
L1S203960LCW-02PCZ	1341.79	LAS15EMZ	129.30
L1S253960LCW-02PCZ	1493.26	LAS15JMZ	112.14
L1S304000LCW-02PCZ	1738.46	LAS20ALZ	112.14
L1S354000LCW-02PCZ	1966.76	LAS20CLZ	94.60
<b>PH-Schienen</b>		LAS20EMZ	141.90
<b>PH-Standard</b>		LAS20JMZ	123.58
<b>Rails PH-standard Rotaie</b>		LAS25ALZ	125.88
<b>PH-standard Railes estándar</b>		LAS25CLZ	97.27
<b>PH-Rails standard</b>		LAS25EMZ	153.34
L1S152920TCW-01PHZ	1386.62	LAS25JMZ	137.32
L1S203960LCW-01PHZ	1788.61	LAS30ALZ	147.10
L1S253960LCW-01PHZ	1990.52	LAS30CLZ	118.98
L1S304000LCW-01PHZ	2317.37	LAS30EMZ	175.07
L1S354000LCW-01PHZ	2621.69	LAS30JMZ	159.00
<b>Schienen von unten</b>		LAS35ALZ	169.81
<b>verschraubbar</b>		LAS35CLZ	139.53
<b>Rails bottom hole mounting</b>		LAS35EMZ	202.26
<b>Rotaie foratura da sotto</b>		LAS35JMZ	183.87
<b>Railes montaje roscado</b>			
<b>inferior</b>		<b>Mit K1 montiert</b>	
<b>Rails montage par le dessous</b>		<b>With K1</b>	
L1S151660LVNG01PCZ	661.17	<b>Con K1</b>	
L1S203960LVNG01PCZ	1744.32	<b>Con K1</b>	
L1S253960LVNG01PCZ	1941.24	<b>Avec K1</b>	
L1S304000LVNG01PCZ	2260.00	LAS15ALZ-K	128.18
L1S354000LVNG01PCZ	2556.79	LAS15CLZ-K	109.87
<b>Schienen rostarm</b>		LAS15EMZ-K	148.77
<b>Rails stainless</b>		LAS15JMZ-K	131.61
<b>Rotaie INOX</b>		LAS20ALZ-K	133.78
<b>Railes inoxidable</b>		LAS20CLZ-K	116.23
<b>Rails acier inoxydable</b>		LAS20EMZ-K	163.53
L1S151000LKNZZ	536.17	LAS20JMZ-K	145.22
L1S151000TKNGZZ	536.17	LAS25ALZ-K	147.51
L1S203500LKNZZ	2075.36	LAS25CLZ-K	118.90
L1S253100LKNZZ	2045.69	LAS25EMZ-K	174.97
L1S303400SZ	2585.96	LAS25JMZ-K	158.95
L1S353500LKNZZ	3011.60		

NSK	€	NSK	€
LAS30ALZ-K	174.14	<b>Rostarm</b>	
LAS30EMZ-K	202.11	<b>Stainless</b>	
LAS35ALZ-K	196.85	<b>INOX</b>	
LAS35CLZ-K	166.57	<b>Inoxidable</b>	
LAS35EMZ-K	229.30	<b>Acier inoxydable</b>	
<b>Mit erhöhter Vorspannung</b>		LAS15ALSZ	190.25
<b>Higher preload</b>		LAS15CLSZ	158.20
<b>Preacarico alto</b>		LAS15EMSZ	226.28
<b>Con precarga alta</b>		LAS20ALSZ	196.25
<b>Forte précharge</b>		LAS20CLSZ	165.55
LAS15ALH	108.71	LAS20EMSZ	248.32
LAS15EMH	129.30	LAS25ALSZ	220.28
LAS20ALH	112.14	LAS25CLSZ	170.22
LAS20CLH	94.60	LAS25EMSZ	268.34
LAS20JMH	123.58	LAS25KLSZ	170.23
LAS25ALH	125.88	LAS30ALSZ	257.42
LAS25CLH	97.27	LAS30CLSZ	208.21
LAS25EMH	153.34	LAS30EMSZ	306.38
<b>Erhöhte Vorspannung und K1</b>		LAS35ALSZ	297.17
<b>Higher preload with K1</b>		LAS35CLSZ	244.17
<b>Preacarico alto e K1</b>		LAS35EMSZ	353.95
<b>Con precarga alta y K1</b>		<b>S1 SERIES</b>	
<b>Forte précharge et K1</b>		<b>FUHRUNGSWAGEN  </b>	
LAS15ALH-K	128.18	<b>CARRIAGES   PATTINI  </b>	
LAS15CLH-K	109.87	<b>PATINES   PATINS</b>	
LAS20ALH-K	133.78	<b>SS Standard</b>	
LAS20CLH-K	116.23	<b>SS Standard</b>	
LAS25ALH-K	147.51	<b>SS Standard</b>	
		<b>SS Estándar</b>	
		<b>SS Standard</b>	
		SAS15ALZ	125.02
		SAS15CLZ	103.96
		SAS15EMZ	148.70
		SAS20ALZ	128.96
		SAS20CLZ	108.79
		SAS20EMZ	163.18
		SAS25ALZ	144.76
		SAS25CLZ	111.86
		SAS25EMZ	176.34
		SAS30ALZ	169.17
		SAS30CLZ	136.82
		SAS30EMZ	201.34
		SAS30JMZ	182.84
		SAS35ALZ	195.28
		SAS35CLZ	160.45
		SAS35EMZ	232.60
		SAS35JMZ	211.45

NSK	€	NSK	€
<b>SS mit K1 montiert</b>		<b>ZUBEHÖR FÜR</b>	
<b>SS with K1</b>		<b>LINEARFÜHRUNGEN</b>	
<b>SS con K1</b>		<b>LS SERIES   ACCESSORIES</b>	
<b>SS con K1</b>		<b>FOR LINEAR GUIDES</b>	
<b>SS avec K1</b>		<b>LS SERIES ACCESSORI PER</b>	
SAS15ALZ-K	144.49	<b>GUIDE SERIE LS  </b>	
SAS15CLZ-K	123.43	<b>ACCESORIOS PARA GUÍAS</b>	
SAS15EMZ-K	168.17	<b>LINEALES DE SERIE LS  </b>	
SAS20ALZ-K	150.59	<b>ACCESSOIRES POUR</b>	
SAS20CLZ-K	130.43	<b>GUIDAGES LINÉAIRES</b>	
SAS20EMZ-K	184.81	<b>SERIE LS</b>	
SAS20JMZ-K	163.75	<b>Kunststoffstopfen</b>	
SAS25ALZ-K	166.39	<b>Plastic caps</b>	
SAS25CLZ-K	133.49	<b>Tappi in plastica</b>	
SAS25EMZ-K	197.97	<b>Tapones de plástico</b>	
SAS25JMZ-K	179.55	<b>Capuchons de trous de</b>	
SAS30ALZ-K	196.21	<b>fixation</b>	
SAS30CLZ-K	163.86	LG-CAP/M03-500P	468.00
SAS30EMZ-K	228.38	LG-CAP/M04-500P	468.00
SAS35ALZ-K	222.32	LG-CAP/M05-500P	478.40
SAS35CLZ-K	187.49	LG-CAP/M06-500P	478.40
SAS35EMZ-K	259.64	LG-CAP/M08-500P	608.40
		<b>K1 Schmiereinheit</b>	
		<b>K1 lubrication unit</b>	
		<b>Unità di lubrificazione K1</b>	
		<b>Unidad de lubricación K1</b>	
		<b>Unité de lubrification K1</b>	
		LS15K1/KIT	77.88
		LS20K1/KIT	69.76
		LS25K1/KIT	75.61
		LS30K1/KIT	79.18
		LS35K1/KIT	85.12
		<b>Gummiabstreifer</b>	
		<b>Seals</b>	
		<b>Guarnizioni</b>	
		<b>Sellados de goma</b>	
		<b>Joints</b>	
		LS20WS-01	13.42
		LS20WSC-01	29.96
		LS25WS-01	13.74
		LS25WSC-01	30.07
		LS30WS-01	16.01
		LS30WSC-01	32.55
		LS35WS-01	16.12
		LS35WSC-01	32.67

NSK	€	NSK	€
<b>Stahlabstreifer</b>		<b>Wagen mit K1 montiert</b>	
<b>Protectors</b>		<b>Carriages with K1</b>	
<b>Protectors</b>		<b>Pattini con K1</b>	
<b>Protectores metálicos</b>		<b>Patines con K1</b>	
<b>Protecteurs</b>		<b>Patins avec K1</b>	
LS15PT-01	9.41	LAW17ELZ-K	256.70
LS15PTC-01	29.75	LAW21ELZ-K	348.98
LS20PT-01	9.63	LAW27ELZ-K	339.60
LS20PTC-01	26.18	LAW35ELZ-K	410.36
LS25PT-01	11.03	LAW50ELZ-K	782.98
LS25PTC-01	27.14		
LS30PT-01	13.08	<b>LU/PU/PE SERIE   LU/PU/PE</b>	
LS30PTC-01	29.74	<b>SERIES   SERIE LU/PU/PE  </b>	
LS35PT-01	13.42	<b>SERIE LU/PU/PE   SERIES</b>	
LS35PTC-01	29.96	<b>LU/PU/PE</b>	
		<b>Schienen Standard</b>	
<b>LW SERIE   LW SERIES  </b>		<b>Rails standard</b>	
<b>LW SERIE   SERIE LW  </b>		<b>Rotaie standard</b>	
<b>SERIE LW</b>		<b>Raïles estándar</b>	
<b>Schienen Standard</b>		<b>Rails standard</b>	
<b>Rails standard</b>		<b>PE SERIES</b>	
<b>Rotaie standard</b>		P1E070600S	488.38
<b>Raïles estándar</b>		P1E090380S	261.96
<b>Rails standard</b>		P1E120790S	472.84
L1W170990	660.96	P1E150990S	745.52
L1W211580	798.08		
L1W271960	971.07	<b>PU SERIES</b>	
L1W352000	1401.40	P1U070375S	100.59
L1W502000	1783.95	P1U090275S	87.15
		P1U090600S	212.99
<b>Wagen Standard</b>		P1U120470S	153.84
<b>Carriages standard</b>		P1U120800S	306.59
<b>Pattini standard</b>		P1U151000S	416.88
<b>Patines estándar</b>			
<b>Patins standard</b>		<b>LU SERIES</b>	
LAW17ELZ	256.70	L1U150990	308.58
LAW21ELZ	249.85	L1U151990	699.69
LAW27ELZ	294.56		
LAW35ELZ	421.70	<b>Wagen Standard</b>	
LAW50ELZ	782.98	<b>Carriages standard</b>	
		<b>Pattini standard</b>	
		<b>Patines estándar</b>	
		<b>Patins standard</b>	
		<b>PE SERIES</b>	
		PAE07TRS	54.33
		PAE09TRS	75.35
		PAE12ARS	80.76
		PAE15ARS	92.32

NSK	€	NSK	€
<b>PU SERIES</b>		<b>Wagen Standard</b>	
PAU07ARS	41.43	<b>Carriages standard</b>	
PAU09TRS	66.14	<b>Pattini standard</b>	
PAU12TRS	63.82	<b>Patines estándar</b>	
PAU15ALS	71.21	<b>Patins standard</b>	
<b>LU SERIES</b>		RAA25ALP6Z	268.92
LAU15AL	77.23	RAA25ALPHH	314.50
<b>Wagen mit K1 montiert</b>		RAA25ANP6Z	268.92
<b>Carriages with K1</b>		RAA25ANPHH	314.50
<b>Pattini con K1</b>		RAA25BLP6Z	313.55
<b>Patines con K1</b>		RAA25BLPHH	367.25
<b>Patins avec K1</b>		RAA25BNP6Z	313.55
<b>PE SERIES</b>		RAA25BNPHH	367.25
PAE07TRS-K	76.92	RAA25EMP6Z	268.92
PAE09TRS-K	96.06	RAA25EMPHH	314.50
PAE12ARS-K	101.47	RAA25GMP6Z	313.55
PAE15ARS-K	113.04	RAA25GMPHH	367.25
<b>PU SERIES</b>		RAA30ALP6Z	320.41
PAU07ARS-K	62.94	RAA30ALPHH	374.41
PAU09TRS-K	88.39	RAA30ANP6Z	320.41
PAU12TRS-K	86.07	RAA30ANPHH	374.41
PAU15ALS-K	93.45	RAA30BLP6Z	369.62
<b>RA SERIE   RA SERIES  </b>		RAA30BLPHH	433.52
<b>RA SERIE   SERIE RA  </b>		RAA30BNP6Z	369.62
<b>SERIE RASCHIENEN</b>		RAA30BNPHH	433.52
<b>Standard</b>		RAA30EMP6Z	320.41
<b>Rails standard</b>		RAA30EMPHH	374.41
<b>Rotaie standard</b>		RAA30GMP6Z	369.62
<b>Railes estándar</b>		RAA30GMPHH	433.52
<b>Rails standard</b>		RAA35ALP6Z	339.87
R1A253900	2801.71	RAA35ALPHH	397.16
R1A303900	3004.98	RAA35ANP6Z	339.87
R1A353900	3417.82	RAA35ANPHH	397.16
R1A453650	3365.07	RAA35BLP6Z	397.09
R1A553600	4708.52	RAA35BLPHH	462.08
R1A653600	5489.40	RAA35BNP6Z	397.09
		RAA35BNPHH	462.08
		RAA35EMP6Z	339.87
		RAA35EMPHH	397.16
		RAA35GMP6Z	397.09
		RAA35GMPHH	462.08
		RAA45ALP6Z	460.02
		RAA45ALPHH	537.67
		RAA45ANP6Z	460.02
		RAA45ANPHH	537.67
		RAA45BLP6Z	534.40
		RAA45BLPHH	623.99

NSK	€	NSK	€
RAA45BNP6Z	534.40	RAA35ANK6Z	339.87
RAA45BNPHH	623.99	RAA35ANKHH	409.34
RAA45EMP6Z	460.02	RAA35BLK6Z	397.09
RAA45EMPHH	537.67	RAA35BLKHH	474.18
RAA45GMP6Z	534.40	RAA35BNK6Z	397.09
RAA45GMPHH	623.99	RAA35BNKHH	474.18
RAA55ALP6Z	695.75	RAA35EMK6Z	339.87
RAA55ANP6Z	695.75	RAA35EMKHH	409.34
RAA55BLP6Z	812.48	RAA35GMK6Z	397.09
RAA55BNP6Z	812.48	RAA35GMKHH	474.18
RAA55EMP6Z	695.75	RAA45ALK6Z	460.02
RAA55GMP6Z	812.48	RAA45ANK6Z	460.02
RAA65ANP6Z	933.77	RAA45BLK6Z	534.40
RAA65BNP6Z	1168.37	RAA45BNK6Z	534.40
RAA65EMP6Z	933.77	RAA45BNKHH	636.08
RAA65GMP6Z	1168.37	RAA45EMK6Z	460.02
		RAA45EMKHH	549.76
<b>Wagen mit K1 montiert</b>		RAA45GMK6Z	534.40
<b>Carriages with K1</b>		RAA45GMKHH	636.08
<b>Pattini con K1</b>		RAA55ALK6Z	695.75
<b>Patines con K1</b>		RAA55ANK6Z	695.75
<b>Patins avec K1</b>		RAA55BLK6Z	812.48
RAA25ALK6Z	268.92	RAA55BNK6Z	812.48
RAA25ALKHH	323.73	RAA55EMK6Z	695.75
RAA25ANK6Z	268.92	RAA55GMK6Z	812.48
RAA25ANKHH	323.73	RAA65ANK6Z	933.77
RAA25BLK6Z	313.55	RAA65BNK6Z	1168.37
RAA25BLKHH	376.48	RAA65EMK6Z	933.77
RAA25BNK6Z	313.55	RAA65GMK6Z	1168.37
RAA25BNKHH	376.48		
RAA25EMK6Z	268.92	<b>TS SERIES</b>	
RAA25EMKHH	323.73	<b>SERIE TRANSLIDE  </b>	
RAA25GMK6Z	313.55	<b>TRANSLIDE SERIES  </b>	
RAA25GMKHH	376.48	<b>SERIE TRANSLIDE  </b>	
RAA30ALK6Z	320.41	<b>SERIE TRANSLIDE  </b>	
RAA30ALKHH	386.50	<b>SERIE TRANSLIDE</b>	
RAA30ANK6Z	320.41	<b>Schienen Standard</b>	
RAA30ANKHH	386.50	<b>Rails standard</b>	
RAA30BLK6Z	369.62	<b>Rotaie standard</b>	
RAA30BLKHH	445.70	<b>Railes estándar</b>	
RAA30BNK6Z	369.62	<b>Rails standard</b>	
RAA30BNKHH	445.70	T1S151960LPN-ZT	518.30
RAA30EMK6Z	320.41	T1S202920LPN-ZT	827.32
RAA30EMKHH	386.50	T1S254000LPN-ZT	1126.16
RAA30GMK6Z	369.62	T1S304040LPN-ZT	1197.55
RAA30GMKHH	445.70	T1S354040LPN-ZT	1421.87
RAA35ALK6Z	339.87		
RAA35ALKHH	409.34		



NSK	€	NSK	€
<b>Schienen schwarz verchromt</b>		<b>Wagen schwarz verchromt</b>	
<b>Rails coated black chrome</b>		<b>Carriages coated black chrome</b>	
<b>Rotaie con trattamento cromo negro</b>		<b>Pattini con trattamento cromo negro</b>	
<b>Railes con cromado negro</b>		<b>Patines con cromado negro</b>	
<b>Rails traités chromage noir</b>		<b>Patins traités chromage noir</b>	
T1S151960LRN-ZT	596.34	TAS20AN-F	113.40
T1S202920LRN-ZT	1015.79	TAS25AN-F	150.72
T1S254000LRN-ZT	1483.52	TAS30AN-F	177.70
T1S303880LRN-ZT	1645.82	TAS35AN-F	200.80
<b>Schienen von unten verschraubbar</b>		<b>FETT-FETTPRESSE-SCHMIERADAPTER-SCHMIERZUBEHÖR   GREASE-GREASE PUMP-NOZZLES-LUBRICATION PARTS</b>	
<b>Rails bottom hole mounting</b>		<b>GRASSO-POMPE PER GRASSO-TUBI E RACCORDI-ACCESSORI PER LUBRIFICAZIONE OS PARA LUBRIFICACIÓN   GRAISSE-POMPE A ACCESOIRES DE LUBRIFICATION</b>	
<b>Rotaie fori di montaggio da sotto</b>		<b>Fette</b>	
<b>Railes montaje roscado inferior</b>		<b>Grease</b>	
<b>Rails montage par le dessous</b>		<b>Grasso</b>	
T1S151960LVN-ZT	518.30	<b>Grasa</b>	
T1S202920LVN-ZT	827.32	<b>Graisse</b>	
T1S304040LVN-ZT	1197.55	NSK GRS AS2	27.68
T1S354040LVN-ZT	1421.87	NSK GRS LG2	137.04
<b>Wagen Standard</b>		NSK GRS LGU	118.44
<b>Carriages standard</b>		NSK GRS LR3	43.59
<b>Pattini standard</b>		NSK GRS NS7	41.96
<b>Patines estándar</b>		NSK GRS NSL	68.46
<b>Patins standard</b>		NSK GRS PS2	37.21
TAS15AN	90.58		
TAS20AN	100.76		
TAS25AN	138.07		
TAS30AN	163.37		
TAS35AN	174.19		

NSK	€	NSK	€
<b>Fettpresse</b>		<b>K1 für LW Series</b>	
<b>Greasepump</b>		<b>K1 for LW Series</b>	
<b>Pompa perr Grasso</b>		<b>K1 per LW Series</b>	
<b>Pistola die engrasa</b>		<b>K1 por LW Series</b>	
<b>Pompe à graisse</b>		<b>K1 pour LW Series</b>	
NSK HGP	190.68	LW17K1/KIT	69.12
<b>Schmieradapter</b>		LW21K1/KIT	70.95
<b>Nozzles</b>		LW27K1/KIT	77.88
<b>Tubi e Raccordi</b>		LW35K1/KIT	77.88
<b>Engrassadores</b>			
<b>Adaptateurs</b>			
NSK HGP NZ1	31.80		
NSK HGP NZ3	114.43		
NSK HGP NZ5	155.11		
NSK HGP NZ6	133.47		
<b>K1 für LH Series</b>			
<b>K1 for LH Series</b>			
<b>K1 per LH Series</b>			
<b>K1 por LH Series</b>			
<b>K1 pour LH Series</b>			
LH15K1/KIT	45.95		
LH20K1/KIT	70.95		
LH25K1/KIT	74.53		
LH30K1/KIT	78.09		
LH35K1/KIT	85.12		
LH45K1/KIT	125.36		
LH55K1/KIT	145.37		
LH65K1/KIT	151.32		
<b>K1 für LS Series</b>			
<b>K1 for LS Series</b>			
<b>K1 per LS Series</b>			
<b>K1 por LS Series</b>			
<b>K1 pour LS Series</b>			
LS15K1/KIT	77.88		
LS20K1/KIT	69.76		
LS25K1/KIT	75.61		
LS30K1/KIT	79.18		
LS35K1/KIT	85.12		

KUGELGEWINDETRIEBE  
BALL SCREWS  
VITI A RICIROLO DI SFERE  
HUSILLOS A BOLAS  
VIS À BILLES

NSK	€	NSK	€
<b>GEROLLTE KUGELGEWINDETRIEBE UND MUTTERN   ROLLED BALLSCREWS AND NUTS   VITI RULLATE E CHIOCCIOLE   HUSILLOS LAMINADOS Y TUERCA   VIS À BILLES ROULÉES ET ÉCROUS</b>		<b>Mutter RNCT Nut RNCT type Chiocciola tipo RNCT Tuerca RNCT Ecrou RNCT</b>	
<b>Gewinde Shaft Asta Eje Vis</b>		RNCT1003A3.5	104.14
RS1003A8	81.24	RNCT1404A3.5S	151.06
RS1006A8	81.24	RNCT1405A2.5S	153.34
RS1208A8	84.68	RNCT1808A3.5S	169.35
RS1212A8	75.52	RNCT2005A2.5	132.75
RS1404A10	91.55	RNCT2005A2.5S	161.36
RS1405A10	91.55	RNCT2505A5	197.96
RS1610A10	92.70	RNCT2505A5S	219.72
RS1610A15	141.90	RNCT2510A5	216.28
RS1616A15	144.19	RNCT2510A5S	234.59
RS1632A15	146.47	RNCT2806A5S	234.59
RS1808A15	144.19	RNCT3210A5S	324.99
RS2005A20	211.70	RNCT3610A5S	330.71
RS2010A20	231.16	RNCT4010A7S	418.83
RS2020A20	195.69	RNCT4512A5S	437.14
RS2040A20	213.99	RNCT5010A7S	508.08
RS2505A25	319.27	RNCT5016A5S	568.73
RS2510A25	319.27	<b>Mutter RNFBL Nut RNFBL type Chiocciola tipo RNFBL Tuerca RNFBL Ecrou RNFBL</b>	
RS2525A25	292.95	RNFBL1006A2.5S	276.93
RS2550A25	345.59	RNFBL1404A3.5S	280.36
RS2806A25	398.23	RNFBL2505A2.5S	303.24
RS3210A30	580.18	RNFBL2510A5S	391.36
RS3232A30	529.82	RNFBL2806A2.5S	344.45
RS3264A40	854.82	RNFBL3210A2.5S	390.22
RS3610A30	654.57	RNFBL3210A5S	439.42
RS4010A40	1364.05	RNFBL3610A5S	548.13
RS4040A40	941.78	<b>Mutter RNSTL Nut RNSTL type Chiocciola tipo RNSTL Tuerca RNSTL Ecrou RNSTL</b>	
RS4080A50	1373.20	RNSTL1405A2.5S	308.97
RS4512A40	1536.84	RNSTL1808A3.5S	386.78
RS5010A40	2032.34	RNSTL2005A2.5S	343.30
RS5016A40	2032.34	RNSTL2010A2.5S	352.45
RS5050A40	1660.43	RNSTL2505A2.5S	328.43
		RNSTL2510A5S	506.94

KUGELGEWINDETRIEBE  
BALL SCREWS  
VITI A RICIROLO DI SFERE  
HUSILLOS A BOLAS  
VIS À BILLES

NSK	€	NSK	€
RNSTL2806A5S	461.16	RNFTL1808A3.5S	264.35
RNSTL3610A5S	693.47	RNFTL2005A2.5	181.95
<b>Mutter RNFCL</b>		RNFTL2005A2.5S	249.46
<b>Nut RNFCL type</b>		RNFTL2010A2.5S	316.98
<b>Chiocciola tipo RNFCL</b>		RNFTL2505A5S	302.10
<b>Tuerca RNFCL</b>		RNFTL2510A2.5	242.60
<b>Ecrou RNFCL</b>		RNFTL2510A2.5S	306.68
RNFCL1212A3	226.57	RNFTL2510A5S	352.45
RNFCL1616A3S	287.23	RNFTL2525A3	279.22
RNFCL1616A6	354.74	RNFTL2525A3S	297.52
RNFCL1632A2	316.98	RNFTL2806A2.5S	302.10
RNFCL1632A2S	324.99	RNFTL2806A5S	335.29
RNFCL1632A6	415.39	RNFTL3210A5S	449.72
RNFCL1632A6S	409.67	RNFTL3232A3S	398.23
RNFCL2020A3S	331.85	RNFTL3610A2.5S	391.36
RNFCL2020A6S	360.46	RNFTL3610A5S	446.28
RNFCL2040A2	355.89	RNFTL4010A7S	576.74
RNFCL2040A2S	363.90	RNFTL4040A3S	496.64
RNFCL2040A6S	460.02	RNFTL5010A7S	640.83
RNFCL2525A3	338.73	RNFTL5016A5S	740.39
RNFCL2525A3S	351.31		
RNFCL2525A6S	373.06	<b>Kugelgewindetriebe</b>	
RNFCL2550A2	387.93	<b>LPR/PR Serie  </b>	
RNFCL2550A2S	391.36	<b>Ballscrews LPR/PR series  </b>	
RNFCL2550A3S	417.68	<b>Viti serie LPR/PR  </b>	
RNFCL3232A6S	470.32	<b>Husillos a bolas serie LPR/PR</b>	
RNFCL3264A3S	500.07	<b>Vis à billes série LPR/PR</b>	
RNFCL3264A6S	591.62	VSP1205K1D0600PP	683.56
RNFCL4040A3S	514.95	VSP1205K1D0900PP	755.90
RNFCL4040A6S	557.29	VSP1205N1D0400PP	522.07
RNFCL4080A6S	890.28	VSP1205N1D0500PP	586.79
RNFCL5050A3S	717.50	VSP1205N1D0900PP	607.98
RNFCL5050A6S	866.27	VSP1505K1D0600PP	730.33
<b>Mutter RNFTL</b>		VSP1505K1D0900PP	809.14
<b>Nut RNFTL type</b>		VSP1505N1D0400PP	562.86
<b>Chiocciola tipo RNFTL</b>		VSP1505N1D0600PP	633.56
<b>Tuerca RNFTL</b>		VSP1505N1D0900PP	712.37
<b>Ecrou RNFTL</b>		VSP1505N1D1200PP	712.37
RNFTL1003A3.5	130.45	VSP1510K1D0600PP	730.33
RNFTL1006A2.5S	223.14	VSP1510K1D0900PP	809.14
RNFTL1208A2.5S	228.86	VSP1510K1D1200PP	809.14
RNFTL1212A3	173.94	VSP1510N1D0400PP	562.86
RNFTL1404A3.5S	233.44	VSP1510N1D0600PP	633.56
RNFTL1405A2.5S	234.59	VSP1510N1D0900PP	712.37
RNFTL1610A2.5S	255.18	VSP1510N1D1200PP	712.37
RNFTL1616A3S	235.74	VSP2005K1D0800PP	872.83
		VSP2005K1D1200PP	952.73

KUGELGEWINDETRIEBE  
BALL SCREWS  
VITI A RICIROLO DI SFERE  
HUSILLOS A BOLAS  
VIS À BILLES

NSK	€	NSK	€
VSP2005K1D2000PP	1186.03	VSP2525N1D2160PP	1074.03
VSP2005N1D0400PP	676.50	VSP2525N1D2500PP	1196.37
VSP2005N1D0600PP	766.21	VSP2525N1D3200PP	1325.78
VSP2005N1D0800PP	766.21	VSP3210K1D0500PP	842.93
VSP2005N1D1200PP	846.15	VSP3210K1D1000PP	957.11
VSP2005N1D1600PP	946.76	VSP3210K1D1500PP	1076.17
VSP2010K1D0800PP	872.83	VSP3210K1D2000PP	1200.70
VSP2010K1D1200PP	952.79	VSP3210K1D2500PP	1466.64
VSP2010N1D0500PP	766.25	VSP3210K1D3200PP	1608.04
VSP2010N1D0800PP	766.25	VSP3210N1D0500PP	727.59
VSP2010N1D1200PP	846.71	VSP3210N1D1000PP	841.29
VSP2010N1D1600PP	946.76	VSP3210N1D1500PP	960.35
VSP2020K1D1200PP	952.73	VSP3210N1D2000PP	1085.43
VSP2020K1D1600PP	1052.78	VSP3210N1D2500PP	1351.41
VSP2020K1D2000PP	1186.03	VSP3210N1D3200PP	1492.75
VSP2020N1D0800PP	766.21	VSP3210N2D4000PP	2212.75
VSP2020N1D1200PP	846.15	VSP3220K1D1000PP	957.11
VSP2020N1D1600PP	946.76	VSP3220K1D1500PP	1076.22
VSP2505K1D0500PP	771.68	VSP3220K1D2000PP	1200.70
VSP2505K1D0700PP	771.68	VSP3220K1D2500PP	1467.18
VSP2505K1D1000PP	865.22	VSP3220K1D3200PP	1608.04
VSP2505K1D1500PP	966.37	VSP3220K1D4000PP	1907.65
VSP2505K1D2000PP	1074.58	VSP3220N1D1000PP	841.29
VSP2505N1D0500PP	655.86	VSP3220N1D1500PP	960.35
VSP2505N1D0700PP	655.86	VSP3220N1D2000PP	1085.43
VSP2505N1D1000PP	749.88	VSP3220N1D2500PP	1351.41
VSP2505N1D1500PP	851.08	VSP3220N1D3200PP	1492.75
VSP2505N1D2000PP	958.76	VSP3232K1D1000PP	957.11
VSP2510K1D0700PP	771.68	VSP3232K1D1500PP	1076.22
VSP2510K1D1200PP	865.22	VSP3232K1D2000PP	1200.70
VSP2510K1D1600PP	966.37	VSP3232K1D2500PP	1467.18
VSP2510K1D2000PP	1074.58	VSP3232K1D3200PP	1608.04
VSP2510K1D2500PP	1311.70	VSP3232K1D4000PP	1907.65
VSP2510K1D3200PP	1441.12	VSP3232N1D1000PP	783.57
VSP2510N1D0700PP	655.86	VSP3232N1D1500PP	960.35
VSP2510N1D1200PP	749.88	VSP3232N1D2000PP	1085.43
VSP2510N1D1600PP	851.08	VSP3232N1D2500PP	1351.41
VSP2510N1D2000PP	959.25	VSP3232N1D3200PP	1492.75
VSP2510N1D2500PP	1196.37	VSP3232N1D4000PP	1791.88
VSP2525K1D1000PP	865.22	VSP4010K1D1000PP	1047.91
VSP2525K1D1500PP	966.37	VSP4010K1D1500PP	1178.96
VSP2525K1D2000PP	1074.58	VSP4010K1D2000PP	1314.39
VSP2525K1D2500PP	1311.70	VSP4010K1D2500PP	1598.78
VSP2525K1D3200PP	1441.12	VSP4010K1D3200PP	1747.25
VSP2525N1D1000PP	749.88	VSP4010N1D1000PP	932.63
VSP2525N1D1500PP	851.03	VSP4010N1D1500PP	1063.68
VSP2525N1D2000PP	958.76	VSP4010N1D2000PP	1199.11

KUGELGEWINDETRIEBE  
BALL SCREWS  
VITI A RICIROLO DI SFERE  
HUSILLOS A BOLAS  
VIS À BILLES

NSK	€	NSK	€
VSP4010N1D2500PP	1483.51	<b>Kugelgewindetriebe</b>	
VSP4010N1D3200PP	1631.97	<b>Compact FA Serie</b>	
VSP4040K1D1500PP	1119.31	<b>Ballscrews compact</b>	
VSP4040K1D2000PP	1314.39	<b>FA series</b>	
VSP4040K1D2500PP	1598.78	<b>Viti compatte serie FA</b>	
VSP4040K1D3200PP	1747.25	<b>Husillos a bolas serie</b>	
VSP4040K1D4000PP	2058.36	<b>Compact FA</b>	
VSP4040K1D4400PP	2220.36	<b>Vis à billes série Compact FA</b>	
VSP4040N1D1500PP	1063.68	PSS0608NAD0150	541.94
VSP4040N1D2000PP	1199.11	PSS0608NBD0150	565.70
VSP4040N1D2600PP	1483.51	PSS0612NBD0150	524.19
VSP4040N1D3200PP	1631.97	PSS0810NBD0150	550.37
VSP4040N1D4000PP	1943.03	PSS0815NAD0150	541.94
VSP5050K1D2000PP	1485.14	PSS0815NAD0150	522.70
VSP5050K1D3000PP	1967.45	PSS0815NBD0150	569.61
VSP5050K1D4000PP	2306.28	PSS0815NBD0150	552.85
VSP5050N1D2000PP	1401.11	PSS1005N1D0171	597.34
VSP5050N1D3000PP	1851.68	PSS1005N1D0221	619.09
VSP5050N1D4000PP	2191.00	PSS1005N1D0321	662.56
VSP5050N1D4500PP	2294.14	PSS1005N1D0421	716.35
		PSS1005N1D0521	759.83
		PSS1010N1D0221	685.45
		PSS1010N1D0321	704.91
		PSS1010N1D0521	767.85
		PSS1205N1D0221	854.82
		PSS1205N1D0321	644.26
		PSS1205N1D0421	683.18
		PSS1205N1D0521	720.93
		PSS1205N1D0621	767.85
		PSS1210N1D0221	714.06
		PSS1210N1D0321	733.52
		PSS1210N1D0421	748.39
		PSS1210N1D0521	775.85
		PSS1210N1D0621	806.76
		PSS1220N1D0271	657.99
		PSS1220N1D0371	669.44
		PSS1220N1D0471	682.02
		PSS1220N1D0571	701.47
		PSS1220N1D0671	719.78
		PSS1230N1D0271	652.27
		PSS1230N1D0371	664.86
		PSS1230N1D0471	688.90
		PSS1230N1D0571	701.47
		PSS1230N1D0671	725.50
		PSS1505N1D0211	725.50
		PSS1505N1D0261	749.54
		PSS1505N1D0361	796.45
<b>Kugelgewindetriebe</b>			
<b>Compact FSS</b>			
<b>Serie Ballscrews</b>			
<b>compact FSS</b>			
<b>series Viti compatte</b>			
<b>serie FSS Husillos a</b>			
<b>bolas serie Compact</b>			
<b>FSS Vis à billes série</b>			
<b>Compact FSS</b>			
FSS1210N1D0900	675.16		
FSS1510N1D0500	608.78		
FSS1510N1D1000	733.52		
FSS1510N1D1450	985.28		
FSS1520N1D1000	670.58		
FSS1520N1D1450	912.04		
FSS2010N1D1450	1105.43		
FSS2020N1D1450	1016.16		
FSS2510N1D1450	1131.74		
FSS2520N1D1450	1021.88		
FSS2525N1D1450	1016.16		

KUGELGEWINDETRIEBE  
BALL SCREWS  
VITI A RICIROLO DI SFERE  
HUSILLOS A BOLAS  
VIS À BILLES

NSK	€	NSK	€
PSS1505N1D0461	845.66	PSS2020N1D1035	1104.28
PSS1505N1D0561	889.15	PSS2020N1D1235	1184.38
PSS1505N1D0661	954.37	PSS2020N1D1435	1248.47
PSS1505N1D0761	999.00	PSS2020N1D1835	1473.90
PSS1510N1D0261	733.52	PSS2030N1D0608	981.83
PSS1510N1D0361	757.56	PSS2030N1D0708	1009.31
PSS1510N1D0461	781.57	PSS2030N1D0908	1039.05
PSS1510N1D0561	812.48	PSS2030N1D1435	1362.90
PSS1510N1D0661	851.39	PSS2040N1D0658	929.20
PSS1510N1D0761	870.84	PSS2040N1D0958	978.40
PSS1510N1D0979	946.37	PSS2040N1D1085	1162.65
PSS1510N1D1179	1211.85	PSS2040N1D1285	1239.31
PSS1520N1D0261	718.64	PSS2040N1D1485	1319.41
PSS1520N1D0361	738.10	PSS2040N1D2285	1731.37
PSS1520N1D0461	755.26	PSS2060N1D0708	978.40
PSS1520N1D0561	775.85	PSS2060N1D1535	1418.98
PSS1520N1D0661	799.88	PSS2505N1D0349	810.18
PSS1520N1D0879	845.66	PSS2505N1D0399	822.78
PSS1520N1D0979	875.41	PSS2505N1D0499	874.27
PSS1520N1D1179	1119.15	PSS2505N1D0599	917.76
PSS1530N1D0411	850.23	PSS2505N1D0699	980.70
PSS1530N1D0511	873.12	PSS2505N1D0899	1085.97
PSS1530N1D0611	893.72	PSS2505N1D0999	1134.04
PSS1530N1D0711	914.32	PSS2505N1D1233	1459.03
PSS1530N1D0811	928.05	PSS2510N1D0549	867.40
PSS1530N1D0929	966.96	PSS2510N1D0649	901.73
PSS1530N1D1029	1123.74	PSS2510N1D0749	931.49
PSS2005N1D0323	815.90	PSS2510N1D0849	969.26
PSS2005N1D0373	827.35	PSS2510N1D0949	1007.01
PSS2005N1D0473	878.84	PSS2510N1D1049	1200.40
PSS2005N1D0573	925.77	PSS2510N1D1283	1313.69
PSS2005N1D0673	985.28	PSS2510N1D1883	1692.46
PSS2005N1D0773	1040.20	PSS2520N1D0729	855.96
PSS2005N1D0873	1088.27	PSS2520N1D0829	871.99
PSS2005N1D1000	1155.77	PSS2520N1D0929	909.74
PSS2010N1D0387	797.61	PSS2520N1D1029	1089.41
PSS2010N1D0487	818.20	PSS2520N1D1263	1182.10
PSS2010N1D0587	860.54	PSS2520N1D1463	1248.47
PSS2010N1D0687	890.28	PSS2520N1D1863	1480.76
PSS2010N1D0787	917.76	PSS2520N1D2263	1740.53
PSS2010N1D1014	1155.77	PSS2525N1D0779	854.82
PSS2010N1D1414	1364.05	PSS2525N1D0879	868.55
PSS2020N1D0508	802.18	PSS2525N1D0979	892.58
PSS2020N1D0608	829.64	PSS2525N1D1079	1075.67
PSS2020N1D0708	851.39	PSS2525N1D1313	1168.37
PSS2020N1D0808	867.40	PSS2525N1D1513	1318.27
PSS2020N1D0908	901.73	PSS2525N1D1913	1447.58

KUGELGEWINDETRIEBE  
BALL SCREWS  
VITI A RICIROLO DI SFERE  
HUSILLOS A BOLAS  
VIS À BILLES

NSK	€	NSK	€
PSS2525N1D2313	1690.19	W1202FA-1P-C3Z5	953.22
PSS2530N1D1513	1502.51	W1202FA-3P-C3Z5	957.81
PSS2550N1D0829	1032.19	W1202FA-5P-C5Z10	957.81
PSS2550N1D1129	1245.03	W1202KA-3P-C3Z5	1190.10
PSS2550N1D1563	1481.91	W1202MA-1PY-C3Z2	770.13
PSS2550N1D1963	1600.92	W1202MA-3PY-C3Z2	773.57
		W1202MA-5PY-C3Z2	770.13
		W1202MA-7PY-C3Z2	773.57
<b>KUGELGEWINDETRIEBE A</b>		W1203FA-1P-C3Z5	981.83
<b>SERIE</b>		W1203FA-3P-C5Z10	960.10
<b>BALLSCREWS A SERIE</b>		W1203MA-1PY-C3Z2	797.61
<b>VITI SERIE A</b>		W1203MA-3PY-C3Z2	797.61
<b>HUSILLOS A BOLAS SERIE A</b>		W1204FA-1P-C3Z5	1082.54
<b>VIS À BILLES SÉRIE A</b>		W1204FA-3P-C5Z10	1024.18
W0400MA-3PY-C3Z1	822.78	W1204FS-2-C5T10	1001.29
W0401MA-1PY-C3Z1	836.51	W1205FA-1P-C3Z5	1322.85
W0600MA-1PY-C3Z1	766.70	W1205FA-3P-C5Z10	1114.58
W0601KA-3PY-C3Z1	1106.57	W1205KA-1P-C3Z5	1650.14
W0601MA-1PY-C3Z1	779.29	W1401FA-1P-C3Z5	769.00
W0601MA-3PY-C3Z1	781.57	W1403FA-1P-C3Z5	822.78
W0800MA-1PY-C3Z1	746.11	W1404FA-1P-C3Z5	908.60
W0800MA-5PY-C3Z2	827.35	W1404FA-5P-C5Z8	860.54
W0801MA-1PY-C3Z1	758.69	W1405FA-1P-C3Z5	1130.59
W0801MA-3PY-C3Z1	758.69	W1406FA-1P-C3Z5	1288.52
W0801MA-9PY-C3Z2	836.51	W1406FA-5P-C5Z8	961.24
W0802MA-1PY-C3Z1	789.59	W1407FA-1P-C5Z8	1048.22
W0802MA-2Y-C3T1	1052.78	W1501FA-1P-C5Z10	839.94
W0802MA-5PY-C3Z2	868.55	W1502FA-1P-C5Z10	860.54
W1001FA-1P-C3Z4	783.87	W1502FA-3P-C5Z10	860.54
W1001FA-3P-C3Z4	783.87	W1502FA-7PG-C5Z20	799.88
W1001MA-1PY-C3Z2	757.56	W1503FA-1P-C5Z10	885.72
W1001MA-3PY-C3Z2	759.83	W1503FA-3P-C5Z10	885.72
W1001MA-8Y-C3T2.5	1013.89	W1503FA-7PG-C5Z20	799.88
W1002FA-3P-C3Z4	799.88	W1504FA-1P-C5Z10	912.04
W1002MA-1PY-C3Z2	788.44	W1504FA-3P-C5Z10	912.04
W1002MA-3PY-C3Z2	789.59	W1504FA-4-C5T10	956.66
W1002MA-4Y-C3T2	1055.08	W1504FA-7PG-C5Z20	853.67
W1002MA-7PY-C3Z2	789.59	W1505FA-1P-C5Z10	923.48
W1003FA-1P-C3Z4	822.78	W1505FA-3P-C5Z10	928.05
W1003FA-3P-C3Z4	827.35	W1505FA-7PG-C5Z20	892.58
W1003FA-4-C3T4	1015.03	W1506FA-1P-C5Z10	1002.44
W1201FA-1P-C3Z5	916.61	W1506FA-3P-C5Z10	1003.58
W1201FA-2-C3T5	933.77	W1506FA-7PG-C5Z20	933.77
W1201FA-3P-C3Z5	918.89	W1507FA-1P-C5Z10	1083.69
W1201FA-5P-C5Z10	933.77	W1507FA-3PG-C5Z20	973.82
W1201MA-1PY-C3Z2	740.39	W1508FA-1P-C5Z10	1184.38
W1201MA-3PY-C3Z2	742.67	W1510FA-1P-C5Z10	1636.40
W1201MA-7PY-C3Z2	742.67		



KUGELGEWINDETRIEBE  
BALL SCREWS  
VITI A RICIROLO DI SFERE  
HUSILLOS A BOLAS  
VIS À BILLES

NSK	€	NSK	€
W1601FA-1P-C3Z5	805.60	W2005FA-5PGX-C5Z4	964.67
W1601KA-3PY-C3Z2	968.10	W2005SA-1P-C5Z4	1219.86
W1601MA-1PY-C3Z2	672.86	W2005SA-2P-C5Z5	1264.48
W1601MA-3PY-C3Z2	674.01	W2006FA-1P-C5Z10	1130.59
W1601MA-7PY-C3Z2.	674.01	W2006FA-3P-C5Z20	938.35
W1602FA-1P-C3Z5	833.07	W2007FA-1P-C5Z10	1170.64
W1602FA-4-C5T16	891.44	W2007FA-5PGX-C5Z4	1222.15
W1602FA-5P-C5Z16	858.25	W2007SA-1P-C5Z5	1408.68
W1602MA-1PY-C3Z2	698.05	W2008FA-1P-C5Z10	1218.71
W1602MA-2Y-C3T2	953.22	W2008FA-3P-C5Z20	1012.73
W1602MA-3PY-C3Z2	698.05	W2008SS-1P-C5Z4	1247.32
W1602MA-5PY-C3Z2.	698.05	W2009FA-1P-C5Z10	1471.61
W1602MA-6Y-C3T2.5	954.37	W2009FA-3P-C5Z20	1192.40
W1602MA-7PY-C3Z2.	698.05	W2009FA-5PGX-C5Z4	1443.01
W1603FA-1P-C3Z5	855.96	W2010FA-1P-C5Z10	1529.98
W1603FA-5P-C5Z16	884.56	W2010FA-3P-C5Z20	1238.17
W1603FA-7PGX-C5Z3	1218.71	W2011FA-1P-C5Z10	1656.99
W1603KA-1PY-C3Z2	1059.66	W2011FA-3P-C5Z20	1332.00
W1603MA-1PY-C3Z2	717.50	W2015FA-1P-C5Z20	1634.10
W1604FA-1P-C3Z5	938.35	W2017FA-1PGX-C5Z4	1976.27
W1604FA-5P-C5Z16	909.74	W2502SA-3P-C5Z5	1012.73
W1605FA-3P-C5Z16	926.91	W2502SA-4P-C5Z5	1013.89
W1605FA-5PGX-C5Z3	1367.48	W2503SA-2P-C5Z5	1019.61
W1606FA-1P-C3Z5	1317.13	W2503SA-4P-C5Z10	1123.74
W1606FA-5P-C5Z16	1002.44	W2503SS-2P-C5Z5	807.90
W1607FA-1P-C5Z16	1082.54	W2504DS-2ZY-C5Z10	1159.20
W1608FA-1P-C3Z5	1698.18	W2504SA-2P-C5Z5	1082.54
W1608FA-3P-C5Z16	1183.24	W2505SA-2P-C5Z5	1295.39
W1610FA-1P-C5Z16	1635.25	W2505SA-3P-C5Z6	1310.26
W1612FA-1PGX-C5Z3	2127.31	W2505SA-4P-C5Z10	1382.35
W2002FA-1P-C5Z10	894.87	W2505SS-1P-C5Z5	1058.51
W2002FA-2-C5T10	929.20	W2506SA-1P-C5Z5	1394.94
W2002SA-1P-C5Z4	953.22	W2506SS-1P-C5Z4	1123.74
W2002SA-2P-C5Z4	954.37	W2506SS-2ZY-C5Z5	1445.29
W2002SA-3P-C5Z5	999.00	W2507FA-1P-C5Z20	1128.32
W2002SA-4P-C5Z5	1000.15	W2507SA-2P-C5Z5	1443.01
W2003FA-1P-C5Z10	912.04	W2507SA-4P-C5Z10	1526.53
W2003FA-2-C5T10	952.09	W2508FA-1PGX-C5Z5	1378.93
W2003FA-3P-C5Z20	869.69	W2508SS-1P-C5Z5	1311.41
W2003SA-1P-C5Z4	960.10	W2509FA-1P-C5Z20	1345.74
W2003SA-2P-C5Z5	1003.58	W2509FA-3P-C5Z25	1344.60
W2003SS-2P-C5Z5	789.59	W2509SA-1P-C5Z5	1848.10
W2004FA-1P-C5Z10	928.05	W2509SA-2P-C5Z10	1930.49
W2004FA-2-C5T10	971.54	W2510SS-1P-C5Z4	1619.23
W2004SA-2P-C5Z5	1064.23	W2510SS-2P-C5Z10	1719.93
W2005FA-1P-C5Z10	1083.69	W2511FA-3P-C5Z25	1494.50
W2005FA-3P-C5Z20	925.77	W2511SA-1P-C5Z5	2139.90

KUGELGEWINDETRIEBE  
BALL SCREWS  
VITI A RICIROLO DI SFERE  
HUSILLOS A BOLAS  
VIS À BILLES

NSK	€	NSK	€
W2511SA-3P-C5Z10	2221.15	W3220DS-2PSS-C5Z2	2136.47
W2512SS-3ZY-C5Z5	2253.19	W3220DS-3PY-C5Z10	3205.07
W2513FA-1P-C5Z20	1562.02	W4007DS-2PY-C5Z5	1631.82
W2515SS-2ZY-C5Z10	2565.60	W4010DS-2PY-C5Z5	2159.36
W2804SS-1P-C5Z5	937.21	W4010DS-4PY-C5Z10	1819.49
W3203SA-2Z-C5Z5	1318.27	W4015DS-1PY-C5Z5	2890.59
W3203SA-6Z-C5Z10	1356.04	W4015DS-3PY-C5Z20	2416.84
W3204DS-1ZY-C5Z5	1518.54	W4015DS-4PY-C5Z10	2341.82
W3204DS-3PY-C5Z10	1424.61	W4020DS-2PY-C5Z20	3535.07
W3204DS-4PSS-C5Z5	1559.76	W4030DS-1PY-C5Z20	5188.36
W3204SA-1P-C5Z5	1225.58	W5010DS-2PY-C5Z10	2538.13
W3204SA-2Z-C5Z5	1342.30	W5015DS-2PY-C5Z10	3225.87
W3205SA-4Z-C5Z6	1526.53	W5015DS-3PY-C5Z20	3701.42
W3205SS-3ZY-C5Z10	1608.93	W5020DS-2PY-C5Z10	3673.31
W3206SA-3Z-C5Z10	1734.81	W5020DS-3PY-C5Z20	3684.79
W3206SS-3P-C5Z6	1224.43	W5025DS-1PY-C5Z20	4076.11
W3207SA-6Z-C5Z10	1830.93	W5030DS-1PY-C5Z20	6136.08
W3208SS-1P-C5Z5	1340.02	W6311DS-1PY-C5Z10	4264.45
W3209SA-1P-C5Z5	1853.82	W6315DS-1PY-C5Z10	5054.46
W3209SS-1ZY-C5Z5	2162.78	W6320DS-1PY-C5Z10	4842.96
W3210SS-4Z-C5Z10	1699.34	W6325DS-1PY-C5Z10	5757.86
W3211SA-2Z-C5Z5	2147.91		
W3211SA-5Z-C5Z10	2225.72	<b>RMA / RMS Serie</b>	
W3212SS-2Z-C5Z5	1780.58	<b>RMA / RMS series</b>	
W3216FA-1P-C5Z25	1637.54	<b>Serie RMA / RMS</b>	
W3218SS-3ZY-C5Z10	2816.21	<b>Serie RMA / RMS</b>	
W3221FA-1P-C5Z25	2095.28	<b>Série RMA / RMS</b>	
W4003SA-1Z-C5Z5	1391.51	RMA0601C7S-160	417.68
W4006SS-1Z-C5Z5	1373.20	RMA0601C7S-260	431.41
W4015SA-1Z-C5Z5	2610.22	RMA0801.5C7S-280	454.30
W5010SS-2Z-C5Z10	2549.57	RMA0801C7S-180	417.68
W5026SS-1Z-C5Z10	4092.14	RMA0801C7S-280	431.41
		RMA0802C7S-180	417.68
		RMA0802C7S-280	431.41
		RMA1002C7S-250	410.81
		RMA1002C7S-350	426.84
		RMA1202C7S-250	410.81
		RMA1202C7S-350	426.84
		RMS0601C7S-300	386.78
		RMS0802C7S-300	398.23
<b>KUGELGEWINDETRIEBE</b>			
<b>DS SERIE   BALLSCREWS</b>			
<b>DS SERIE   VITI SERIE DS</b>			
<b>HUSILLOS A BOLAS  </b>			
<b>SERIE DS   VIS À BILLES</b>			
<b>SÉRIE DS</b>			
W3207DS-2PSS-C5Z5	1391.51		
W3207DS-4PY-C5Z10	1232.45		
W3210DS-2PSS-C5Z5	1820.63		
W3210DS-4PSS-C5Z2	1523.11		
W3210DS-5PY-C5Z10	2242.34		
W3215DS-1PSS-C5Z5	2439.73		
W3215DS-3PSS-C5Z2	1901.89		
W3215DS-4PY-C5Z10	2070.10		

LAGERUNGEN FÜR KUGELGEWINDETRIEBE  
SUPPORT UNITS FOR BALLSCREWS  
SUPPORTI PER VITI  
SOPORTES PARA HUSILLOS A BOLAS  
UNITÉS SUPPORT DE VIS À BILLES

NSK	€	NSK	€
WBK04-01M	204.40	WBK25-01W	599.05
WBK04-11M	191.63	WBK25-11	475.68
WBK04R-11	87.61	WBK25DF-31	779.53
WBK06-01A	175.60	WBK25DF-31H	779.53
WBK06-01M	204.40	WBK25DFD-31	843.63
WBK06-11	134.14	WBK25DFD-31H	843.63
WBK06L-01	11.00	WBK25K	16.45
WBK06R-11	86.59	WBK25L-01	20.20
WBK08-01A	207.10	WBK25L-31	72.43
WBK08-01B	207.10	WBK25L-31H	72.43
WBK08-11	170.70	WBK25S-01W	159.60
WBK08-11B	170.70	WBK30DF-31	817.35
WBK08K	9.30	WBK30DF-31H	817.35
WBK08L-01	13.87	WBK30DFD-31	875.12
WBK08S-01	57.39	WBK30DFD-31H	875.12
WBK08S-01B	57.39	WBK30L-31	71.88
WBK10-01A	222.97	WBK30L-31H	71.88
WBK10-01B	222.97	WBK35DF-31	754.71
WBK10-11	177.60	WBK35DF-31H	754.71
WBK10K	9.54	WBK35DFD-31	906.52
WBK10L-01	11.39	WBK35DFD-31H	906.52
WBK10S-01	69.99	WBK35DFF-31	1055.11
WBK12-01A	213.03	WBK35DFF-31H	1055.11
WBK12-01B	213.03	WBK35L-31	75.83
WBK12-11	174.83	WBK35L-31H	75.83
WBK12K	9.79	WBK40DF-31	830.64
WBK12L-01	14.65	WBK40DF-31H	830.64
WBK12S-01	70.63	WBK40DFD-31	983.90
WBK12S-01B	70.63	WBK40DFD-31H	983.90
WBK15-01A	265.65	WBK40DFF-31	1132.99
WBK15-01B	265.65	WBK40DFF-31H	1132.99
WBK15-11	192.25	WBK40L-31	78.60
WBK15K	10.51	WBK40L-31H	78.60
WBK15L-01	14.60		
WBK15S-01	84.65		
WBK15S-01B	84.65		
WBK17DF-31H	765.58		
WBK17L-31H	69.30		
WBK20-01	395.41		
WBK20-11	370.20		
WBK20DF-31	849.57		
WBK20DF-31H	849.57		
WBK20K	12.41		
WBK20L-01	17.23		
WBK20L-31	86.63		
WBK20L-31H	86.63		
WBK20S-01	130.25		

## MONOCARRIER

NSK	€	NSK	€
<b>Monocarrier</b>		MCM06040H20K	2698.09
<b>Serie MCM P-Type</b>		MCM06050H10K	3022.66
<b>MCM P-Type</b>		MCM06060H10K	3428.36
<b>MCM P-Type</b>		MCM06070H10K	3834.12
<b>MCM tipo P</b>		MCM06080H10K	4239.83
<b>Série MCM Type P</b>		MCM08010H05K	2616.95
MCM02010P02K	1240.64	MCM08010H10K	2495.21
MCM02015P01K	1451.27	MCM08020H10K	2657.54
MCM03005P02K	1303.07	MCM08030H10K	2860.37
MCM03010P01K	1376.41	MCM08030H20K	2860.37
MCM03010P02K	1332.39	MCM08040H10K	3124.12
MCM03015P01K	1442.42	MCM08040H20K	3124.12
MCM03015P02K	1381.27	MCM08050H10K	3448.68
		MCM08060H10K	3793.58
<b>Serie MCM</b>		MCM08080H10K	4665.86
<b>MCM series</b>		MCM10020H10K	2799.56
<b>Serie MCM</b>		MCM10030H10K	2982.11
<b>Serie MCM</b>		MCM10030H20K	2982.11
<b>Série MCM</b>		MCM10040H10K	3245.81
MCM03005P01K	1307.98	MCM10040H20K	3245.81
MCM03010H10K	1523.13	MCM10060H10K	3854.40
MCM03020H10K	1689.31	MCM10080H10K	4706.41
MCM03025H10K	1779.78	MCM10080H20K	4706.41
MCM05005H05K	1399.73	MCM10100H10K	5213.57
MCM05005H10K	1359.19	MCM10100H20K	5213.57
MCM05010H05K	1562.06		
MCM05010H10K	1521.51	<b>Serie MCM mit 2 Wagen</b>	
MCM05015H05K	1744.62	<b>MCM series with 2 blocks</b>	
MCM05015H10K	1683.75	<b>Serie MCM con 2 pattini</b>	
MCM05020H05K	1927.22	<b>Serie MCM con dos patines</b>	
MCM05020H10K	1866.30	<b>Série MCM avec 2 patins</b>	
MCM05025H10K	2008.31	MCM05016H10D	2523.29
MCM05030H10K	2150.32	MCM05031H10D	3030.47
MCM05030H20K	2150.32	MCM06011H05D	2641.36
MCM05040H10K	2515.53	MCM06021H05D	2945.71
MCM05050H10K	2819.78	MCM06031H05D	3351.41
MCM05050H20K	2819.78	MCM06031H10D	3270.27
MCM06005H05K	1501.19		
MCM06005H10K	1460.60	<b>MONOCARRIER</b>	
MCM06010H05K	1663.48	<b>ACCESSORIES MCM</b>	
MCM06010H10K	1622.93	<b>Motoradapter</b>	
MCM06020H05K	2069.18	<b>Motorbracket</b>	
MCM06020H10K	2008.31	<b>Staffa Motore</b>	
MCM06030H10K	2312.66	<b>Soporte de motor</b>	
MCM06030H20K	2312.66	<b>Lanterne d'adaptation</b>	
MCM06040H05K	2779.23	MC-BK03-146-00	227.69
MCM06040H10K	2698.09	MC-BK03-231-00	152.91

## MONOCARRIER

NSK	€	NSK	€
MC-BK05-146-00	291.30	<b>Sensoren</b>	
MC-BK06-170-00	317.81	<b>Sensor units</b>	
MC-BK08-160-00	338.60	<b>Sensori</b>	
MC-BK08-170-00	338.60	<b>Sensores</b>	
MC-BK08-250-00	338.60	<b>Kit capteurs</b>	
<b>Abdeckbleche</b>		MC-SR02-00	520.17
<b>Cover</b>		MC-SR05-00	120.16
<b>Copertura</b>		MC-SR05-01	120.16
<b>Tapas</b>		MC-SR05-02	120.16
<b>Capots</b>		MC-SR05-11	395.34
MC-CV02005-00	102.98	MC-SR05-12	395.34
MC-CV03005-00	305.81	MC-SR05-13	213.25
MC-CV03010-01	311.05	MC-SR06-00	120.16
MC-CV03015-01	316.24	MC-SR06-01	120.16
MC-CV05015-00	634.62	MC-SR06-10	395.34
MC-CV05020-00	647.61	MC-SR06-12	395.34
MC-CV05025-00	663.22	MC-SR06-13	213.25
MC-CV05030-00	671.03	MC-SR08-00	120.16
MC-CV05030-01	140.96	MC-SR08-01	120.16
MC-CV05040-00	694.44	MC-SR10-00	120.16
MC-CV05040-01	143.05	MC-SR10-01	104.51
MC-CV06010-00	558.14	MC-SR10-02	120.16
MC-CV06020-00	582.60	<b>Sensor Schienen</b>	
MC-CV06020-01	139.39	<b>Sensor rails</b>	
MC-CV06030-00	608.59	<b>Distanziale</b>	
MC-CV06040-00	634.10	<b>Rail sensor</b>	
MC-CV06040-01	149.29	<b>Rails Kit capteurs</b>	
MC-CV06060-00	685.07	MC-SRH10-10	312.09
MC-CV06070-00	710.05	MC-SRL2-0100	21.84
MC-CV06070-01	162.33	MC-SRL5-0230	37.45
MC-CV08010-00	572.18	MC-SRL5-0280	41.12
MC-CV08020-00	600.83	MC-SRL6-0190	23.41
MC-CV08030-00	632.00	<b>Sensoren</b>	
MC-CV08040-00	690.11	<b>Sensor units</b>	
MC-CV08050-00	691.82	<b>Sensori</b>	
MC-CV08060-00	720.47	<b>Sensores</b>	
MC-CV08080-00	780.25	<b>Kit capteurs</b>	
MC-CV10020-00	634.62	MC-SR-HSA	29.13
MC-CV10030-00	665.79	MC-SRL-0200	26.03
MC-CV10040-00	699.63	MC-SRL-0300	29.13
MC-CV10050-00	733.42	MC-SRL-0680	43.16
		MC-SRL-0740	43.69
		MC-SRL-1180	60.34

MONOCARRIER

NSK	€	NSK	€
<b>MONOCARRIER</b>		<b>Abdeckbleche</b>	
<b>MCH-SERIE</b>		<b>Cover</b>	
<b>Serie MCH</b>		<b>Copertura</b>	
<b>MCH series</b>		<b>Tapas</b>	
<b>Serie MCH</b>		<b>Capots</b>	
<b>Serie MCH</b>		MC-HV06030-00	109.22
<b>Série MCH</b>		MC-HV06040-00	112.36
MCH06005H05K	1431.52	MC-HV06050-00	114.93
MCH06010H05K	1581.29	MC-HV09030-00	163.85
MCH06010H10K	1548.02	MC-HV10050-00	233.00
MCH06020H05K	1914.18	MC-HV10105D00	412.99
MCH06020H10K	1880.91		
MCH06030H10K	2147.24	<b>Sensoren</b>	
MCH06030H10K	2147.24	<b>Sensor units</b>	
MCH06030H20K	2113.82	<b>Sensori</b>	
MCH06040H10K	2463.52	<b>Sensores</b>	
MCH06040H20K	2430.20	<b>Kit capteurs</b>	
MCH06050H10K	2763.14	MC-SR-HSA	29.13
MCH09020H05K	2496.78	MC-SRL-0200	26.03
MCH09020H10K	2430.20	MC-SRL-0300	29.13
MCH09030H05K	2929.57	MC-SRL-0680	43.16
MCH09040H05K	3395.62	MC-SRL-0740	43.69
MCH09080H10K	5026.83	MC-SRL-1180	60.34
MCH09080H20K	4943.64	<b>Sensor Schienen</b>	
MCH10040H10K	3129.31	<b>Sensor rails</b>	
MCH10060H20K	4011.54	<b>Distanziale</b>	
MCH10080H10K	5193.05	<b>Rail sensor</b>	
MCH10080H20K	5110.07	<b>Rails Kit capteurs</b>	
MCH10100H10K	6085.90	MC-SRH10-10	312.09
MCH10100H20K	5924.67		
<b>Serie MCH mit 2 Wagen</b>			
<b>MCH series with 2 blocks</b>			
<b>Serie MCH con 2 pattini</b>			
<b>Serie MCH con dos patines</b>			
<b>Série MCH avec 2 patins</b>			
MCH10035H10D	4574.87		
MCH10055H10D	5523.63		
MCH10105H20D	7687.51		

MEGATORQUE MOTOR PS SERIE  
 MEGATORQUE MOTOR PS SERIE  
 MOTORE MEGATORQUE SERIE PS  
 MOTORES MEGATORQUE SERIE PS  
 MOTEUR MEGATORQUE PS

NSK	€	NSK	€
<b>Megatorque Motor PN SERIES</b>		<b>Zubehör</b>	
<b>Motoren</b>		<b>Accessories</b>	
<b>Motors</b>		<b>Accessori</b>	
<b>Motori</b>		<b>Accesorios</b>	
<b>Motores</b>		<b>Accessoires</b>	
<b>Moteur</b>		M-E014DCFS1-001	82.93
M-PN2012KN201	8541.31	M-E014DCFS1-002	34.02
M-PN3045KN001	7938.39	M-E014DCKR1-100	59.80
M-PN4135KN001	9093.99	M-E099DC0C2-145	96.99
M-PN4180KN001	9998.36	M-FHT21	864.43
M-PS1006KN002	3567.25	<b>Kabel</b>	
M-PS1012KN002	4019.44	<b>Cables</b>	
M-PS1018KN002	4471.63	<b>Cavi</b>	
M-PS3015KN002	4255.99	<b>Cables</b>	
M-PS3030KN002	4918.07	<b>Cables</b>	
M-PS3060KN002	6280.38	M-C002SCP13	301.41
M-PS3090KN002	7285.24	M-C004SCP13	411.46
		M-C008SCP13	631.51
<b>Steuerungen</b>		M-C015SCP13	1016.58
<b>Drivers</b>		M-C030SCP13	1841.89
<b>Drivers</b>			
<b>Controladores</b>			
<b>Driver</b>			
M-EDC-PN2012AB502	3567.25		
M-EDC-PN3045AB502	3717.98		
M-EDC-PN4135AB502	3717.98		
M-EDC-PN4180AB502	3717.98		
<b>Megatorque Motor PS SERIES</b>			
<b>Steuerungen</b>			
<b>Drivers</b>			
<b>Drivers</b>			
<b>Controladores</b>			
<b>Driver</b>			
M-EDC-PS1006AB102	5099.69		
M-EDC-PS1006AB502	3567.25		
M-EDC-PS1006AB502	3366.28		
M-EDC-PS1012AB502	3366.28		
M-EDC-PS1018AB502	3366.28		
M-EDC-PS1018AB502	3567.25		
M-EDC-PS3015AB502	3366.28		
M-EDC-PS3030AB502	3366.28		
M-EDC-PS3060AB502	3517.01		
M-EDC-PS3090AB502	3517.01		





## NSK Sales Offices – Europe, Middle East and Africa

### UK

NSK UK Ltd.  
Northern Road, Newark  
Nottinghamshire NG24 2JF  
Tel. +44 (0) 1636 605123  
Fax +44 (0) 1636 643276  
info-uk@nsk.com

### France

NSK France S.A.S.  
Quartier de l'Europe  
2, rue Georges Guynemer  
78283 Guyancourt Cedex  
Tel. +33 (0) 1 30573939  
Fax +33 (0) 1 30570001  
info-fr@nsk.com

### Germany, Austria, Switzerland, Benelux, Nordic

NSK Deutschland GmbH  
Harkortstraße 15  
40880 Ratingen  
Tel. +49 (0) 2102 4810  
Fax +49 (0) 2102 4812290  
info-de@nsk.com

### Italy

NSK Italia S.p.A.  
Via Garibaldi, 215  
20024 Garbagnate  
Milanese (MI)  
Tel. +39 02 995 191  
Fax +39 02 990 25 778  
info-it@nsk.com

### Middle East

NSK Bearings Gulf Trading Co.  
JAFZA View 19, Floor 24 Office 2/3  
Jebel Ali Downtown,  
PO Box 262163  
Dubai, UAE  
Tel. +971 (0) 4 804 8205  
Fax +971 (0) 4 884 7227  
info-me@nsk.com

### Poland & CEE

NSK Polska Sp. z o.o.  
Warsaw Branch  
Ul. Migdałowa 4/73  
02-796 Warszawa  
Tel. +48 22 645 15 25  
Fax +48 22 645 15 29  
info-pl@nsk.com

### Russia

NSK Polska Sp. z o.o.  
Russian Branch  
Office I 703, Bldg 29,  
18<sup>th</sup> Line of Vasilievskiy Ostrov,  
Saint-Petersburg, 199178  
Tel. +7 812 3325071  
Fax +7 812 3325072  
info-ru@nsk.com

### South Africa

NSK South Africa (Pty) Ltd.  
27 Galaxy Avenue  
Linbro Business Park  
Sandton 2146  
Tel. +27 (011) 458 3600  
Fax +27 (011) 458 3608  
nsk-sa@nsk.com

### Spain

NSK Spain, S.A.  
C/ Tarragona, 161 Cuerdo Bajo  
2<sup>a</sup> Planta, 08014 Barcelona  
Tel. +34 93 2892763  
Fax +34 93 4335776  
info-es@nsk.com

### Turkey

NSK Rulmanları Orta Doğu Tic. Ltd. Şti  
19 Mayıs Mah. Atatürk Cad.  
Ulya Engin İş Merkezi No: 68/3 Kat. 6  
P.K.: 34736 - Kozyatağı - İstanbul  
Tel. +90 216 4777111  
Fax +90 216 4777174  
turkey@nsk.com

Please also visit our website: [www.nskeurope.com](http://www.nskeurope.com) | Global NSK: [www.nsk.com](http://www.nsk.com)

